

Yealink



SIP-T58V

Smart Media Phone User Guide SIP-T58V & T58A & T56A

**Version 83.5
Sep. 2018**

Copyright

Copyright © 2018 YEALINK(XIAMEN) NETWORK TECHNOLOGY

Copyright © 2018 Yealink (Xiamen) Network Technology CO., LTD. All rights reserved. No parts of this publication may be reproduced or transmitted in any form or by any means, electronic or mechanical, photocopying, recording, or otherwise, for any purpose, without the express written permission of Yealink (Xiamen) Network Technology CO., LTD. Under the law, reproducing includes translating into another language or format.

When this publication is made available on media, Yealink (Xiamen) Network Technology CO., LTD. gives its consent to downloading and printing copies of the content provided in this file only for private use but not for redistribution. No parts of this publication may be subject to alteration, modification or commercial use. Yealink (Xiamen) Network Technology CO., LTD. will not be liable for any damages arising from use of an illegally modified or altered publication.

Trademarks

Yealink®, the logo and the name and marks is trademark of Yealink (Xiamen) Network Technology CO., LTD, which are registered legally in China, the United States, EU (European Union) and other countries.

All other trademarks belong to their respective owners. Without Yealink's express written permission, recipient shall not reproduce or transmit any portion hereof in any form or by any means, with any purpose other than personal use.

Warranty

(1) **Warranty**

THE SPECIFICATIONS AND INFORMATION REGARDING THE PRODUCTS IN THIS GUIDE ARE SUBJECT TO CHANGE WITHOUT NOTICE. ALL STATEMENTS, INFORMATION, AND RECOMMENDATIONS IN THIS GUIDE ARE BELIEVED TO BE ACCURATE AND PRESENTED WITHOUT WARRANTY OF ANY KIND, EXPRESS OR IMPLIED. USERS MUST TAKE FULL RESPONSIBILITY FOR THEIR APPLICATION OF PRODUCTS.

(2) **Disclaimer**

YEALINK (XIAMEN) NETWORK TECHNOLOGY CO., LTD. MAKES NO WARRANTY OF ANY KIND WITH REGARD TO THIS GUIDE, INCLUDING, BUT NOT LIMITED TO, THE IMPLIED WARRANTIES OF MERCHANTABILITY AND FITNESS FOR A PARTICULAR PURPOSE. Yealink (Xiamen) Network Technology CO., LTD. shall not be liable for errors contained herein nor for incidental or consequential damages in connection with the furnishing, performance, or use of this guide.

(3) **Limitation of Liability**

Yealink and/or its respective suppliers are not responsible for the suitability of the information contained in this document for any reason. The information is provided "as is", and Yealink does not provide any warranty and is subject to change without notice. All risks other than risks caused by use of the information are borne by the recipient. In no event, even if Yealink has been suggested the occurrence of damages that are direct, consequential, incidental, special, punitive or whatsoever (Including but not limited to loss of business profit, business interruption or loss of business information), shall not be liable for these damages.

End User License Agreement

This End User License Agreement ("EULA") is a legal agreement between you and Yealink. By installing, copying or otherwise using the Products, you: (1) agree to be bounded by the terms of this EULA, (2) you are the owner or an authorized user of the device, and (3) you represent and warrant that you have the right, authority and capacity to enter into this agreement and to abide by all its terms and conditions, just as if you had signed it. The EULA for this product is available on the Yealink Support page for the product.

Patent Information

China, the United States, EU (European Union) and other countries are protecting one or more patents of accompanying products and/or patents being applied by Yealink.

Customer Feedback

We are striving to improve our documentation quality and we appreciate your feedback. Email your opinions and comments to DocsFeedback@yealink.com.

Technical Support

Visit Yealink WIKI (<http://support.yealink.com/>) for the latest firmware, guides, FAQ, Product documents, and more. For better service, we sincerely recommend you to use Yealink Ticketing system (<https://ticket.yealink.com>) to submit all your technical issues.

GNU GPL INFORMATION

Yealink SIP-T58V/T58A/T56A smart media phone firmware contain third-party software under the GNU General Public License (GPL). Yealink uses software under the specific terms of the GPL. Please refer to the GPL for the exact terms and conditions of the license.

The original GPL license, source code of components licensed under GPL and used in Yealink products can be downloaded online: http://www.yealink.com/onepage_83.html.

Table of Contents

| | |
|---|-----------|
| Table of Contents | 1 |
| About This Guide | 13 |
| Related Documentation | 13 |
| In This Guide | 13 |
| Getting Started with Your Phone | 15 |
| Hardware Overview | 15 |
| T58V/A Hardware | 15 |
| T56A Hardware | 17 |
| Power LED Indicator | 19 |
| T58V/A Camera LED Indicator | 19 |
| Screen and Icons | 19 |
| Control Center/Notification Center | 20 |
| Idle Screen | 21 |
| The Home Screen | 22 |
| The Second Idle Screen | 23 |
| The Third Idle Screen | 24 |
| Configuration Screen | 24 |
| Dialing/Pre-dialing Screen | 25 |
| Video Call Screen | 25 |
| Icons in the Status Bar | 27 |
| Line Key Icons | 28 |
| Call History Icons | 32 |
| Navigating Menus and Fields | 32 |
| Entering Characters | 33 |
| Using the Onscreen Keyboard | 33 |
| English (UK) Input Method | 33 |
| Google Pinyin Input Method | 36 |
| Using the Phone Keypad and Dial Pad | 37 |
| Customizing Your Phone | 39 |
| Changing the Administrator Password | 39 |
| Wallpaper | 39 |
| Changing Wallpaper on Idle Screen | 40 |
| Adding a Wallpaper from a USB Flash Drive | 40 |
| Screen Saver | 40 |
| Changing the Waiting Time for Screen Saver | 40 |
| Setting the Screen Saver Type | 40 |
| Changing the Screen Backlight Brightness and Time | 41 |
| Changing the Backlight and Time on Idle Screen | 41 |
| Changing the Backlight on Control Center | 41 |
| Changing the Language | 43 |

| | |
|--|-----------|
| Changing the Input Method | 43 |
| Time & Date | 44 |
| Setting the Time and Date Manually | 44 |
| Changing the Time and Date Format | 44 |
| Setting a Key as Send | 45 |
| Phone Lock | 45 |
| Phone Lock and Waiting Time | 45 |
| Setting the Phone Lock | 46 |
| Locking Your Phone Manually | 46 |
| Unlocking Your Phone | 46 |
| Changing Your Phone Unlock PIN | 47 |
| Line Keys | 47 |
| Assigning Functionality to a Line Key | 47 |
| Changing the Location of the Line Keys | 48 |
| Deleting a Line Key | 49 |
| Wireless Network | 50 |
| Activating the Wi-Fi Mode | 50 |
| Deactivating the Wi-Fi Mode | 50 |
| Connecting to the Wireless Network | 50 |
| Connecting to an Available Wireless Network Manually | 51 |
| Connecting to the Wireless Network Using Wi-Fi Protected Setup (WPS) | 51 |
| Adding a Wireless Network Manually | 52 |
| Viewing the Wireless Network Information | 53 |
| Disconnecting the Wireless Network Connection | 54 |
| Bluetooth | 54 |
| Activating the Bluetooth Mode | 55 |
| Deactivating the Bluetooth Mode | 55 |
| Pairing and Connecting the Bluetooth Headset | 55 |
| Pairing and Connecting the Bluetooth-Enabled Mobile Phone | 56 |
| Configuring the Phone Audio Feature | 57 |
| Configuring the Media Audio Feature | 57 |
| Syncing the Mobile Contacts to the IP Phone | 58 |
| Enabling the Mobile Contacts Sync Feature | 58 |
| Viewing Your Mobile Contacts on the IP Phones | 58 |
| Disabling the Mobile Contacts Sync Feature | 59 |
| Handling a Mobile Phone Call on the IP Phone | 59 |
| Editing Device Name of your Phone for Recognition | 60 |
| Making the Phone Discoverable | 60 |
| Renaming the Paired Bluetooth Device | 60 |
| Unpairing the Bluetooth Device | 61 |
| Sending Files via Bluetooth | 61 |
| Receiving Files via Bluetooth | 61 |
| Disconnecting the Bluetooth Device | 62 |
| Audio Settings | 65 |

| | |
|--|-----------|
| Adjusting the Volume | 65 |
| Adjusting the Audio Volume | 65 |
| Adjusting the Ringer Volume | 65 |
| Adjusting the Media Volume | 65 |
| Setting the Ring Tone | 66 |
| Setting a Ring Tone for the Phone | 66 |
| Setting a Ring Tone for an Account | 67 |
| Setting a Ring Tone for a Group | 67 |
| Setting a Ring Tone for a Contact | 67 |
| Setting the Key Tone | 68 |
| Enabling Touch Sounds | 68 |
| Configuring Notification Sound | 68 |
| Enabling Silent Mode | 69 |
| Directory | 71 |
| Local Directory | 71 |
| Managing the Local Directory Groups | 71 |
| Adding Contact Groups | 71 |
| Editing Contact Groups | 71 |
| Deleting Contact Groups | 72 |
| Managing the Local Directory Contacts | 72 |
| Adding Contacts | 72 |
| Editing Contacts | 73 |
| Deleting a Contact | 73 |
| Deleting All Contacts | 73 |
| Moving a Local Directory Contact to Blacklist | 73 |
| Moving a Local Directory Contact to the Shared Directory | 74 |
| Searching for Contacts | 74 |
| Blacklist | 75 |
| Adding a Blacklist Contact | 75 |
| Editing a Blacklist Contact | 75 |
| Deleting Blacklist Contacts | 75 |
| Deleting a Blacklist Contact | 75 |
| Deleting all Blacklist Contacts | 76 |
| Moving a Blacklist Contact to the Local Directory | 76 |
| Mobile Contacts | 76 |
| Adding a Mobile Contact to the Local Directory/Blacklist | 76 |
| Searching for Mobile Contacts | 77 |
| Updating the Mobile Contacts | 77 |
| Google Contacts | 78 |
| Enabling the Google Contacts Feature | 78 |
| Viewing Google Contacts | 78 |
| Adding a Google Contact | 79 |
| Editing a Google Contact | 79 |
| Deleting a Google Contact | 79 |

| | |
|--|-----------|
| Searching for Google Contacts | 79 |
| Manually Updating the Google Contacts | 80 |
| Remote Phone Book | 80 |
| Searching for Remote Phone Book Contacts | 80 |
| Adding a Remote Phone Book Contact to the Local Directory or Blacklist | 81 |
| Call History | 83 |
| Viewing History Records | 83 |
| Adding a History Record to Local Directory or Blacklist | 83 |
| Adding a History Record to Shared Directory | 83 |
| Deleting History Records | 84 |
| Deleting a Call Record | 84 |
| Deleting All Call Records | 84 |
| Disabling History Record | 84 |
| Call Features | 87 |
| Switching Among the Handset, Speakerphone and Headset Modes | 87 |
| Changing the Default Account | 88 |
| Placing Calls | 88 |
| Placing a Call from the Dialer | 88 |
| Placing Multiple Calls | 89 |
| Placing a Call with a Speed Dial Key | 89 |
| Setting a Speed Dial Key Manually | 90 |
| Speed Dialing a Contact Using a Speed Dial Key | 90 |
| Placing a Call Back to the Last Incoming Number | 90 |
| Setting a Recall Key | 90 |
| Recalling a Contact | 91 |
| Redialing a Number | 91 |
| Dialing a Hotline Number | 91 |
| Setting a Hotline Number and Delay Time | 91 |
| Placing an International Call | 92 |
| Placing a Call from the Call History | 92 |
| Placing a Call from the Directory | 92 |
| Placing an Anonymous Call | 92 |
| Enabling Anonymous Call | 93 |
| Placing an Anonymous Call | 93 |
| Placing a Call from the Google Contacts | 94 |
| Answering Calls | 94 |
| Answering a Call | 94 |
| Answering a Call When in a Call | 95 |
| Enabling Call Waiting | 95 |
| Answering a Call Automatically | 95 |
| Audio-only/Video Call Selection | 96 |
| Placing an Audio-only/Video Call | 96 |
| Answering a Video Call | 97 |

| | |
|---|-----|
| Switching between Video Call and Audio-only Call | 97 |
| Switching to the Audio-only Call | 98 |
| Initiating a Video Call | 98 |
| Accepting or Ignoring a Video Call Request | 98 |
| Switching Between Calls Screen and Idle Screen | 98 |
| Going to the Idle Screen during a Call | 99 |
| Returning to the Talking Screen | 99 |
| Options During a Video Call | 100 |
| Stopping Transmitting Video during a Call | 101 |
| Changing the Video Layout during Calls | 101 |
| Swapping Video During a Video Call | 101 |
| Changing the Video Layout to the Same Size Mode During a Video Call | 102 |
| Changing the Video Layout to the Full Screen Mode During a Video Call | 103 |
| Changing the Video Layout During a Video Conference Call | 104 |
| Previewing the Near-Site Video (Only for T58A) | 105 |
| Capturing a Screenshot | 105 |
| Capturing a Screenshot on the Control Center | 105 |
| Capturing a Screenshot During a Call | 106 |
| Silencing or Rejecting Incoming Calls | 107 |
| Silencing a Call | 107 |
| Rejecting a Call Manually | 108 |
| Rejecting Anonymous Calls Automatically | 108 |
| Ending Calls | 108 |
| Auto Redial | 108 |
| Setting the Auto Redial | 109 |
| Redialing a Call Automatically | 109 |
| Call Mute | 109 |
| Muting/Unmuting Audio | 110 |
| Keep Mute | 110 |
| Call Hold | 111 |
| Holding a Call | 111 |
| Resuming a Held Call | 111 |
| Swapping Between Active and Held Calls | 111 |
| Do Not Disturb (DND) | 111 |
| Rejecting Calls with DND on All Lines | 112 |
| Rejecting Calls with DND on Specific Lines | 113 |
| Deactivating DND | 113 |
| Redirecting Incoming Calls | 114 |
| Forwarding All Incoming Calls to a Contact | 114 |
| Forwarding All Incoming Calls on All Lines | 114 |
| Forwarding All Incoming Calls on Specific Lines | 115 |
| Deactivating Call Forward | 115 |
| Forwarding an Incoming Call Manually | 115 |
| Forwarding Incoming Calls with a Forward Key | 116 |

| | |
|--|-----|
| Setting a Forward Key | 116 |
| Forwarding Incoming Calls Using a Forward Key | 116 |
| Transferring Calls | 116 |
| Performing a Blind Transfer | 117 |
| Performing a Blind Transfer Normally | 117 |
| Performing a Blind Transfer Conveniently | 117 |
| Performing a Semi-Attended/Attended Transfer | 119 |
| Performing Transfer with a Transfer Key | 120 |
| Setting a Transfer Key | 120 |
| Performing a Blind Transfer Using a Transfer Key | 120 |
| Performing a Semi-Attended/Attended Using a Transfer Key | 120 |
| Conference Calls | 121 |
| Local Conference | 121 |
| Setting Up a Local Conference Call | 122 |
| Joining Two Calls in a Conference | 122 |
| Creating a Hybrid Conference | 123 |
| Holding or Resuming a Conference Call | 123 |
| Muting or Unmuting a Conference Call | 123 |
| Splitting a Conference Call | 124 |
| Managing Conference Participants | 124 |
| Ending a Conference Call | 124 |
| Network Conference | 124 |
| Setting Up a Network Conference | 124 |
| Call Recording | 125 |
| Recording a Call | 125 |
| Recording a Conference | 126 |
| Managing a Call While Recording | 126 |
| Setting a Mark When Recording a Call | 126 |
| Stopping a Recording | 126 |
| Playing a Recorded Call | 127 |
| Pause/Resuming a Playback | 127 |
| Fast Forwarding/Rewinding a Playback | 127 |
| Stopping a Playback | 128 |
| Deleting a Recorded File | 128 |
| Checking Storage Space | 128 |
| Multicast Paging | 128 |
| Sending Multicast Paging | 129 |
| Setting a Multicast Paging Key | 129 |
| Setting a Paging List Key | 129 |
| Setting a Paging Group | 130 |
| Deleting a Paging Group | 130 |
| Sending a Paging by a Multicast Paging Key | 130 |
| Sending Pages by a Paging List Key | 131 |
| Receiving Multicast Paging | 131 |

| | |
|--|------------|
| Managing a Paging Call | 131 |
| Advanced Features | 133 |
| Call Completion | 133 |
| Enabling Call Completion | 133 |
| Using Call Completion | 133 |
| Call Pickup | 134 |
| Picking up a Call Directly | 135 |
| Picking up a Group Call Directly | 135 |
| Picking up a Call with a Directed Pickup Key | 135 |
| Setting a Directed Pickup Key | 136 |
| Directed Picking up a Call Using a Directed Pickup Key | 136 |
| Picking up a Call with a Group Pickup Key | 136 |
| Setting a Group Pickup Key | 136 |
| Picking up a Group Call Using a Group Pickup Key | 137 |
| Call Park and Call Retrieve | 137 |
| Parking or Retrieving a Call in the FAC Mode | 138 |
| Parking a Call | 138 |
| Retrieving a Parked Call in the FAC Mode | 138 |
| Parking or Retrieving a Call in the Transfer Mode | 139 |
| Parking a Call in the Transfer Mode | 139 |
| Retrieving a Parked Call in the Transfer Mode | 139 |
| Parking or Retrieving a Call with a Park or Retrieve Key | 140 |
| Setting a Park Key | 140 |
| Parking a Call using a Park Key | 140 |
| Setting a Retrieve Key | 140 |
| Retrieving a Parked Call using a Retrieve Key | 141 |
| Busy Lamp Field (BLF) | 141 |
| Setting a BLF Key | 141 |
| State Indicator of Remote Line by BLF Key | 142 |
| Visual Alert for Monitored Lines | 142 |
| Picking up a Remote Call by BLF Key | 143 |
| Setting the Directed Call Pickup Code for BLF key | 143 |
| Picking up a Remote Call | 143 |
| Transferring a Call by BLF Key | 144 |
| Performing a Blind Transfer | 144 |
| Performing a Semi-attended/Attended Transfer | 144 |
| Parking or Retrieving a Call by BLF Key | 144 |
| Parking a Call | 145 |
| Retrieving a Parked Call | 145 |
| BLF List | 145 |
| State Indicator of Remote Line by BLF List Key | 145 |
| Visual Alert for Monitored Lines | 146 |
| Picking up a Remote Call by BLF List Key | 146 |
| Transferring a Call by BLF List Key | 146 |

| | |
|--|------------|
| Performing a Blind Transfer | 146 |
| Performing a Semi-attended/Attended Transfer | 147 |
| Retrieving a Call by a BLF List Key | 147 |
| Barging In an Active Call by BLF List Key | 147 |
| Shared Line | 147 |
| State Indicator of Shared Line | 148 |
| Placing Calls on a Shared Line | 149 |
| Answering Calls on a Shared Line | 149 |
| Placing a Call on Public Hold | 149 |
| Placing a Call on Private Hold | 149 |
| Setting a Private Hold Key | 149 |
| Holding a Call Privately | 150 |
| Retrieving a Held Call Remotely on a Shared line | 150 |
| Barging In an Active Call on a Shared line | 150 |
| Pulling a Shared Call on a Shared line | 151 |
| Intercom | 151 |
| Placing an Intercom Call | 152 |
| Setting an Intercom Key | 152 |
| Placing an Intercom Call to the Target Extension | 152 |
| Picking Up an Incoming Call of the Target Extension | 153 |
| Setting the Directed Call Pickup Code for Intercom Key | 153 |
| Picking Up a Remote Call by Intercom Key | 153 |
| Answering an Intercom Call | 153 |
| Setting Intercom | 154 |
| Answering an Intercom Call | 154 |
| Video/Voice Mail | 155 |
| Setting the Voice Mail Code | 155 |
| Receiving a Voice Message | 155 |
| Leaving Voice Mails | 156 |
| Listening to Voice Mails | 156 |
| Hot Desking | 157 |
| Automatic Call Distribution (ACD) | 157 |
| Logging into the ACD System | 158 |
| Changing the ACD Status | 158 |
| System Applications | 159 |
| Managing Applications and Widgets | 159 |
| Adding a Widget to the Idle Screen | 159 |
| Resizing a Widget | 160 |
| Moving an Application or Widget | 160 |
| Removing a Widget from the Idle Screen | 161 |
| Creating a Folder | 161 |
| Renaming a Folder | 162 |
| Managing Running Applications | 163 |
| APP Accounts | 164 |

| | |
|---|-----|
| Adding APP Accounts | 164 |
| Syncing APP Account Information | 164 |
| Removing APP Accounts | 165 |
| File Manager | 166 |
| Viewing Files | 166 |
| Searching Files | 167 |
| Copying Files | 167 |
| Cutting Files (Moving Files) | 168 |
| Deleting Files | 168 |
| Sharing Pictures/Videos/Audios via Bluetooth | 169 |
| Sharing Pictures/Videos/Audios via Email | 170 |
| Gallery | 170 |
| Viewing Pictures/Videos | 171 |
| Editing Pictures | 172 |
| Rotating Pictures | 172 |
| Adding a Filter for Pictures | 172 |
| Adding a Frame for Pictures | 173 |
| Cropping Pictures | 173 |
| Coloring Pictures | 173 |
| Setting a Picture as Wallpaper | 173 |
| Printing Pictures | 174 |
| Viewing Detail Information of the Pictures/Videos | 174 |
| Deleting Pictures/Videos | 174 |
| Taking a Picture/Video (Only for T58V/A) | 175 |
| Sharing Pictures/Videos via Bluetooth | 175 |
| Sharing Pictures/Videos via Email | 177 |
| Recorder | 178 |
| Recording Audios | 178 |
| Playing the Recorded Audios | 179 |
| Pause/Resuming a Playback | 179 |
| Fast Forwarding/Rewinding a Playback | 179 |
| Stopping a Playback | 180 |
| Renaming the Recorded Audios | 180 |
| Deleting a Recorded File | 180 |
| Deleting All Recorded Audios | 180 |
| Checking Storage Space | 181 |
| Camera | 181 |
| Inserting the USB Camera(CAM50) to the T58V/A Phone | 181 |
| Taking Pictures | 181 |
| Recording Videos | 182 |
| Camera Settings | 182 |
| Email | 182 |
| Signing In Email | 183 |
| Sending Emails | 183 |

| | |
|---|------------|
| Reading Emails | 183 |
| Deleting Emails | 184 |
| Marking/Printing Email | 184 |
| Adding Multiple Email Accounts | 184 |
| Using Email Widget | 185 |
| Sending Files via Email | 186 |
| Browser | 186 |
| Browsing a Web Page | 186 |
| Managing Bookmarks | 187 |
| Adding a Web Page to the Bookmarks List | 187 |
| Opening a Web Page from the Bookmarks List | 187 |
| Editing a Bookmark | 187 |
| Deleting a Bookmark | 188 |
| Setting a Home Page | 188 |
| Clearing the Navigation History | 189 |
| Modifying Browser Settings | 189 |
| Calendar | 189 |
| Signing In Calendar | 189 |
| Creating an Event | 190 |
| Checking Events | 190 |
| Modifying the Calendar Settings | 191 |
| Calculator | 192 |
| Clock | 192 |
| Alarm | 192 |
| Setting an Alarm Clock | 192 |
| Editing an Alarm Clock | 193 |
| Deleting an Alarm Clock | 193 |
| Setting the Alarm Sound | 193 |
| Clock | 194 |
| Adding the Clock of Other Cities | 194 |
| Configuring the Clock Display Mode | 194 |
| Timer | 194 |
| Setting a Timer | 195 |
| Stopwatch | 195 |
| Setting a Stopwatch | 195 |
| Optional Accessories with Your Phone | 197 |
| Supported Accessories | 197 |
| Headset | 197 |
| Analog Headset | 197 |
| Connecting a YHS32/YHS33 Headset | 197 |
| Bluetooth Headset | 197 |
| USB Headset | 198 |
| Connecting a USB Headset | 198 |
| Using Headsets | 198 |

| | |
|--|------------|
| Activating the Headset Mode | 198 |
| Deactivating the Headset Mode | 198 |
| Expansion Module and Your Phone | 199 |
| Connecting the Expansion Module | 199 |
| Assigning the Features for Ext Keys | 199 |
| Adjusting the Screen Saver of Expansion Module | 199 |
| Adjusting the Backlight of Expansion Module | 199 |
| Changing the EXP Wallpaper from Phone | 200 |
| Adding an EXP Wallpaper from a USB Flash Drive | 200 |
| Using Handsets on T58V/T58A/T56A Phone | 201 |
| Attaching the DECT USB Dongle DD10K | 201 |
| Handset Registration | 201 |
| Setting the Phone to the Handset Registration Mode | 201 |
| Registering a Handset | 202 |
| De-registering a Handset on the Handset | 202 |
| De-registering a Handset on the Phone | 202 |
| DECT Intercom | 203 |
| Configuring Auto Intercom | 203 |
| Placing a DECT Intercom Call on the Handset | 203 |
| Placing a DECT Intercom Call on the Phone | 204 |
| Placing a DECT Intercom Call with a DECT Intercom Key | 204 |
| Setting a DECT Intercom Key Manually | 204 |
| Placing a DECT Intercom Call Using a DECT Intercom Key | 204 |
| Performing a Blind Transfer to the Handset | 205 |
| Merging the DECT Intercom Call with SIP Call into a Conference | 205 |
| Repeater Mode | 205 |
| Enabling the Repeater Mode | 205 |
| Setting the Phone to the Repeater Registration Mode | 206 |
| Registering a Repeater | 206 |
| Master-Slave Mode | 206 |
| Selecting a Slave Handset for Your Phone | 207 |
| Push an Active Call to the Slave Handset | 207 |
| Pull an Active Call from the Slave Handset | 208 |
| Shared Directory | 208 |
| Adding Shared Contacts | 208 |
| Editing Shared Contacts | 209 |
| Deleting a Shared Contact | 209 |
| Deleting All Shared Contacts | 209 |
| Searching for Shared Directory Contacts | 209 |
| Moving a Shared Contact to the Blacklist Directory | 210 |
| Moving a Shared Contact to the Local Directory | 210 |
| Placing a Call from the Shared Directory | 210 |
| Renaming the Handset | 210 |
| Locating a Handset | 210 |

| | |
|--|------------|
| Changing Base PIN | 211 |
| Maintaining Your Phone | 213 |
| Investigating Warnings | 213 |
| Clearing Warnings | 213 |
| Rebooting Your Phone | 214 |
| Resetting to Factory Settings | 214 |
| Updating the Phone Configuration | 214 |
| Appendix - Menu Structure | 217 |

About This Guide

Thank you for choosing the SIP-T58V/T58A/T56A IP phones, a smart media phone for which is exquisitely designed to provide business telephony features, such as Call Hold, Call Transfer, Busy Lamp Field, Call Recording, Multicast Paging and Conference over an IP network. SIP-T58V/T58A/T56A is a smart media phone with a 7-inch capacitive touch screen that runs on Android OS version 5.1.1. The difference between the SIP-T58V and SIP-T58A smart media phones is that the Yealink USB camera CAM50 is an optional accessory for the SIP-T58A IP phone. With the CAM50, you can easily turn your SIP-T58A into a video phone. The difference between the SIP-T58V/SIP-T58A (hereinafter referred to as SIP-T58V/A) and SIP-T56A is that the SIP-T56A does not support the camera.

This guide provides everything you need to quickly use your new phone. Firstly, verify with your system administrator that the IP network is ready for phone configuration. Also be sure to read the Quick Start Guide which can be found in your phone package before you set up and use the IP phone. As you read this guide, keep in mind that some features are only configurable by your system administrator or determined by your phone environment. As a result, some features may not be enabled or may be operated differently on your phone. Additionally, the examples and graphics in this guide may not directly reflect what is displayed or is available on your phone screen.

Read the [Yealink Products Regulatory Notices guide](#) for all regulatory and safety guidance.

Related Documentation

You can obtain additional information of the following phones from Yealink Support:

- [Smart Media Phone SIP-T58A](#)
- [Smart Media Phone SIP-T58V](#)
- [Smart Media Phone SIP-T56A](#)

The following types of related documents are available on each support page:

- Release Notes, which details bug fixes and feature enhancements when an update is released.
- Quick Start Guide, which describes how to assemble your phone and configure the basic phone features.
- Wall Mount Installation Guide, which provides detailed instructions on how to use an optional wall mount bracket to mount your phone on the wall.
- Administrator Guide, which provides the detailed information on how to configure phone features for system administrator.
- Regulatory Notice, which provides information about all regulatory and safety guidance.

In This Guide

Chapters in this guide include:

- Chapter 1 [About This Guide](#)
- Chapter 2 [Getting Started with Your Phone](#)
- Chapter 3 [Customizing Your Phone](#)
- Chapter 4 [Audio Settings](#)
- Chapter 5 [Directory](#)
- Chapter 6 [Call History](#)
- Chapter 7 [Call Features](#)
- Chapter 8 [Advanced Features](#)
- Chapter 9 [System Applications](#)

- [Chapter 10 Optional Accessories with Your Phone](#)
- [Chapter 11 Using Handsets on T58V/T58A/T56A Phone](#)
- [Chapter 12 Maintaining Your Phone](#)
- [Chapter 13 Appendix - Menu Structure](#)

Getting Started with Your Phone

This chapter provides the overview of phone hardware and screen layout, and introduces how to navigate your phone for the best performance.

Topics

[Hardware Overview](#)

[Screen and Icons](#)

[Navigating Menus and Fields](#)

[Entering Characters](#)

Hardware Overview

Topics

[T58V/A Hardware](#)

[T56A Hardware](#)

[Power LED Indicator](#)

[T58V/A Camera LED Indicator](#)

T58V/A Hardware

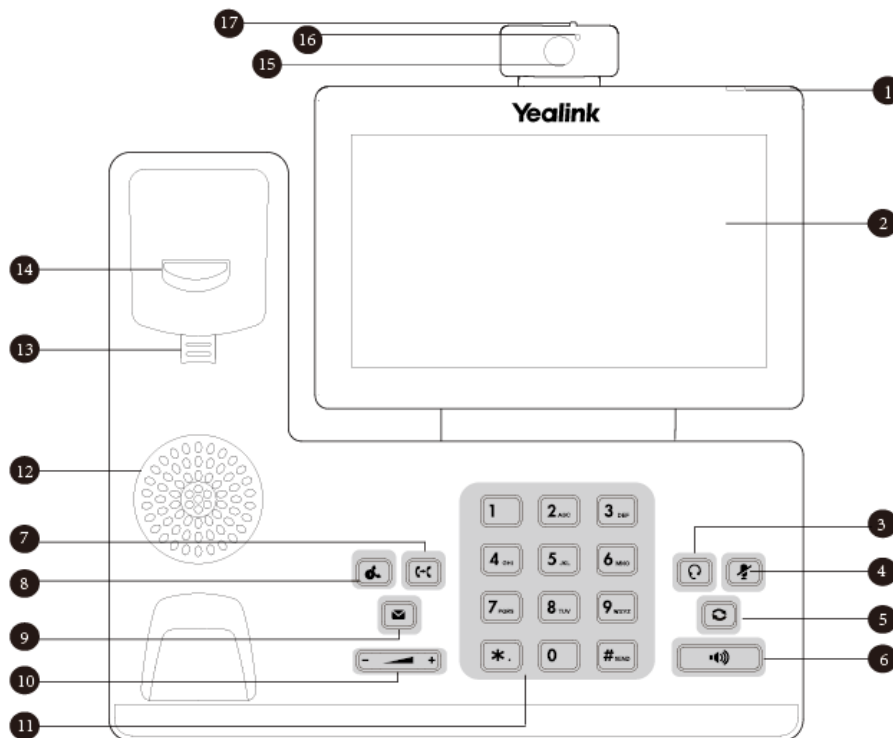

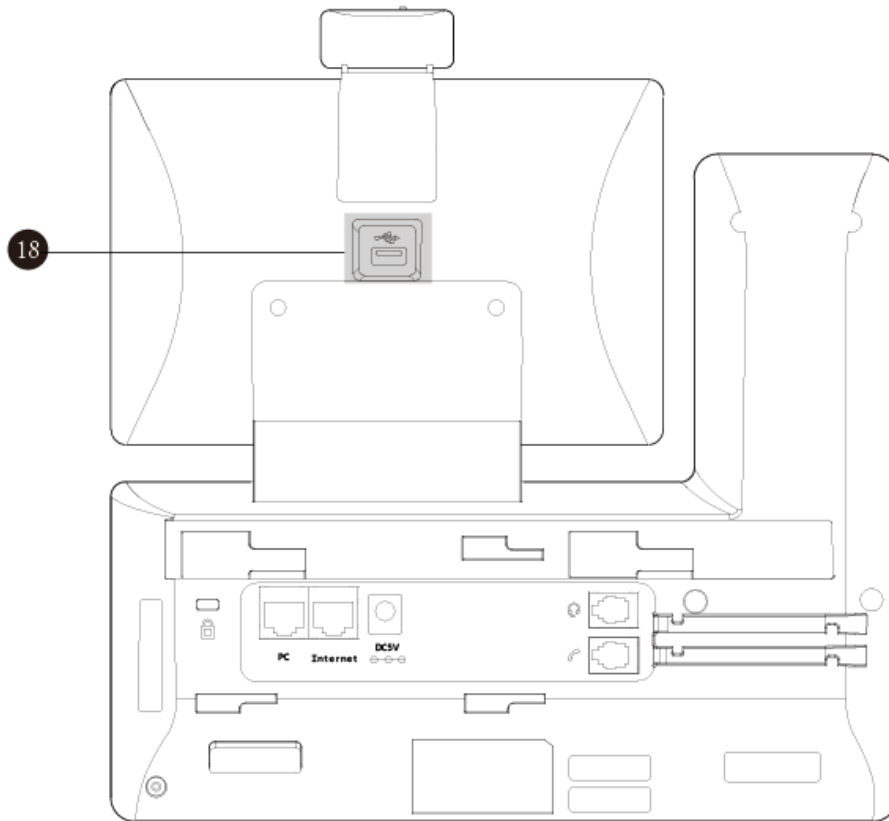



| | Item | Description |
|---|---------------------|--|
| 1 | Power LED indicator | Indicates call status, message status and phone's system status. <ul style="list-style-type: none"> • Receives an incoming call—Fast-flashing • Receives a voice mail—Slow-flashing |
| 2 | Touch Screen | 7 inch (1024 x 600) capacitive (5 points) touch screen. Tap to select and highlight screen items. The IP phone supports three idle screens by default. Shows information about calls, messages, time, date and other relevant data: <ul style="list-style-type: none"> • Default account • Call information—caller ID, call duration • Icons (for example, ) • Missed call list or second incoming caller information • Prompt text (for example, "Save successfully!") • Time and date |
| 3 | HEADSET Key | Toggles and indicates the headset mode. The key LED glows solid green when headset mode is activated. |
| 4 | MUTE Key | Toggles and indicates mute feature. The key LED glows solid red when the call is muted. |
| 5 | REDIAL Key | Redials a previously dialed number. |
| 6 | Speakerphone Key | Toggles and indicates the hands-free (speakerphone) mode. The key LED glows solid green when the hands-free (speakerphone) mode is activated. |
| 7 | TRANSFER Key | Transfers a call to another party. |
| 8 | HOLD Key | Places a call on hold or resumes a held call. |
| 9 | MESSAGE Key | <ul style="list-style-type: none"> • Accesses voice mails. |

| | Item | Description |
|----|----------------------|---|
| | | <ul style="list-style-type: none"> • Captures screenshots during a video call. |
| 10 | Volume Key | Adjusts the volume of the handset, headset, speaker, ringer or media. |
| 11 | Keypad | Provides the digits and special characters in context-sensitive applications. |
| 12 | Speaker | Provides hands-free (speakerphone) audio output. |
| 13 | Reversible Tab | Secures the handset in the handset cradle when the IP phone is mounted vertically. For more information on how to adjust the reversible tab, refer to Yealink Wall Mount Quick Installation Guide for Yealink IP Phones . |
| 14 | Hookswitch | <ul style="list-style-type: none"> • Picking up the handset from the handset cradle, the hookswitch bounces and the phone connects to the line. • Laying the handset down on the handset cradle, the phone disconnects from the line. |
| 15 | Camera Lens | 2 Mega-pixel camera. Provides near-site video. The better distance between camera and images you want to capture should be in the range of 0.35 meters (1 foot) to 2 meters (6 feet). |
| 16 | Camera LED indicator | <p>Indicates video call status and camera status.</p> <ul style="list-style-type: none"> • Receives a video call—Flashing green • The camera is inserted and detected successfully on the phone—Solid green |
| 17 | Shutter Switch | Covers and uncovers the camera. When the camera is switched off, the video image is black. |
| 18 | USB2.0 Port | Allows you to connect an optional USB flash drive/EXP50/USB headset/DD10K to your phone. |

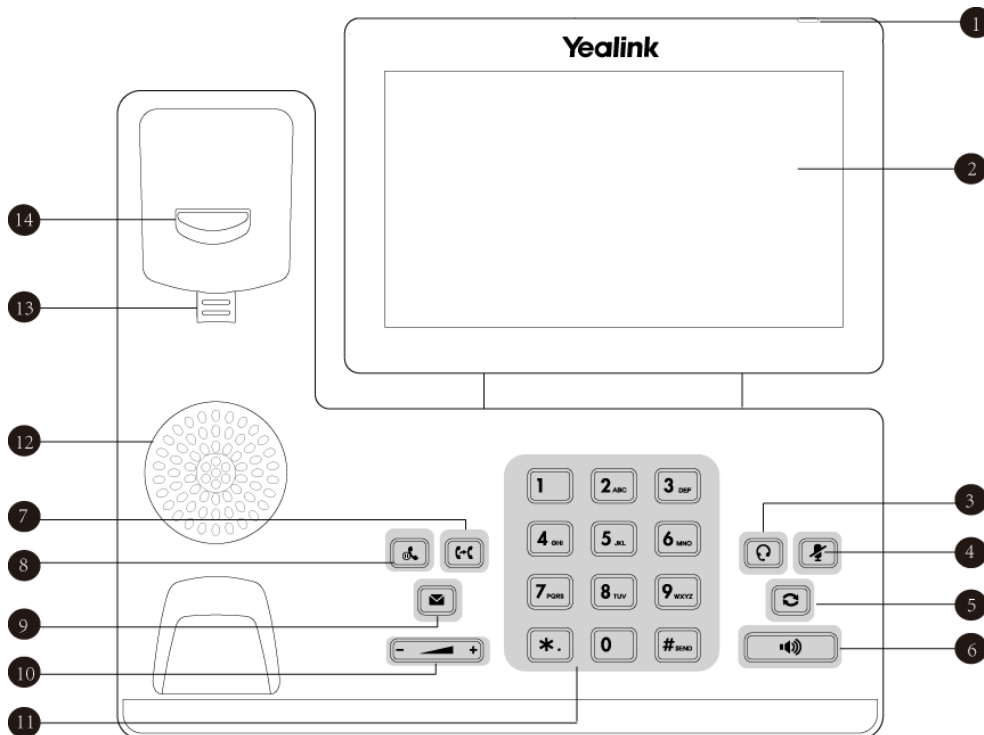
T56A Hardware

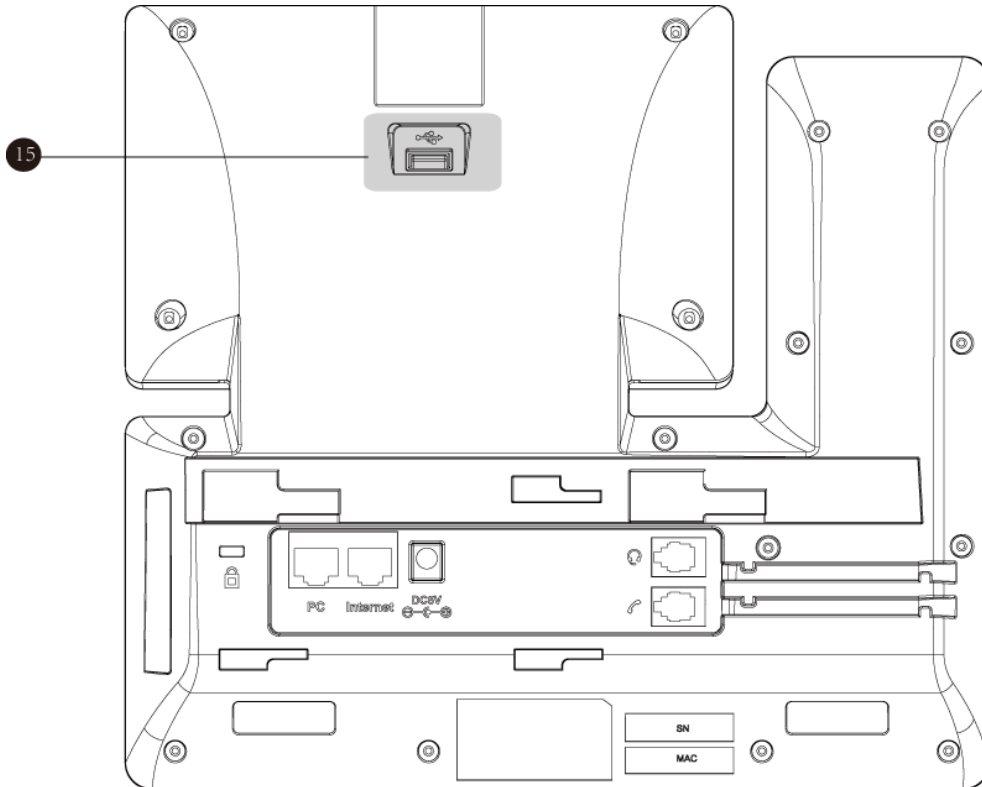



| | Item | Description |
|---|---------------------|--|
| 1 | Power LED indicator | Indicates call status, message status and phone's system status. <ul style="list-style-type: none"> • Receives an incoming call—Fast-flashing • Receives a voice mail—Slow-flashing |
| 2 | Touch Screen | 7 inch (1024 x 600) capacitive (5 points) touch screen. Tap to select and highlight screen items. The IP phone supports three idle screens by default. Shows information about calls, messages, time, date and other relevant data: <ul style="list-style-type: none"> • Default account • Call information—caller ID, call duration • Icons (for example, ) • Missed call list or second incoming caller information • Prompt text (for example, "Save successfully!") • Time and date |
| 3 | HEADSET Key | Toggles and indicates the headset mode. The key LED glows solid green when headset mode is activated. |
| 4 | MUTE Key | Toggles and indicates mute feature. The key LED glows solid red when the call is muted. |
| 5 | REDIAL Key | Redials a previously dialed number. |
| 6 | Speakerphone Key | Toggles and indicates the hands-free (speakerphone) mode. The key LED glows solid green when the hands-free (speakerphone) mode is activated. |
| 7 | TRANSFER Key | Transfers a call to another party. |
| 8 | HOLD Key | Places a call on hold or resumes a held call. |
| 9 | MESSAGE Key | Accesses voice mails. |

| | Item | Description |
|----|----------------|---|
| 10 | Volume Key | Adjusts the volume of the handset, headset, speaker, ringer or media. |
| 11 | Keypad | Provides the digits and special characters in context-sensitive applications. |
| 12 | Speaker | Provides hands-free (speakerphone) audio output. |
| 13 | Reversible Tab | Secures the handset in the handset cradle when the IP phone is mounted vertically. For more information on how to adjust the reversible tab, refer to Yealink Wall Mount Quick Installation Guide for Yealink IP Phones . |
| 14 | Hookswitch | <ul style="list-style-type: none"> Picking up the handset from the handset cradle, the hookswitch bounces and the phone connects to the line. Laying the handset down on the handset cradle, the phone disconnects from the line. |
| 15 | USB2.0 Port | Allows you to connect an optional USB flash drive/EXP50/USB headset/DD10K to your phone. |

Power LED Indicator

| LED Status | Description |
|---------------------------|----------------------------------|
| Solid red | The phone is initializing. |
| Fast-flashing red (300ms) | The phone is ringing. |
| Slow-flashing red (1s) | The phone receives a voice mail. |

Note

The above introduces the default LED status. Your system administrator can configure the status of the power LED indicator.

T58V/A Camera LED Indicator

| LED Status | Description |
|-------------------|---|
| Solid green | The phone is powered on and the camera is properly connected to the phone. The camera is idle. The phone receives an audio-only call. |
| Flashing green | The phone receives a video call. |
| Solid red | There is an active video call. The video call is muted. The video call is held. |
| Slow-flashing red | The shutter switch is open, but the near-site video is stopped transmitting during a video call. The video call is placed on hold. |
| Off | The phone is powered off. The camera is not properly connected to the phone. The shutter switch is closed. |

Screen and Icons

Before you use the phone, you need to be familiar with the state of your phone, including phone screen layout and icons.

Topics

[Control Center/Notification Center](#)

- [Idle Screen](#)
- [Configuration Screen](#)
- [Dialing/Pre-dialing Screen](#)
- [Video Call Screen](#)
- [Icons in the Status Bar](#)
- [Line Key Icons](#)
- [Call History Icons](#)

Control Center/Notification Center

Control center or notification center allows you to access common features or view important notifications quickly.

Procedure

1. Swipe down from the top of the screen to enter the control center and the notification center:

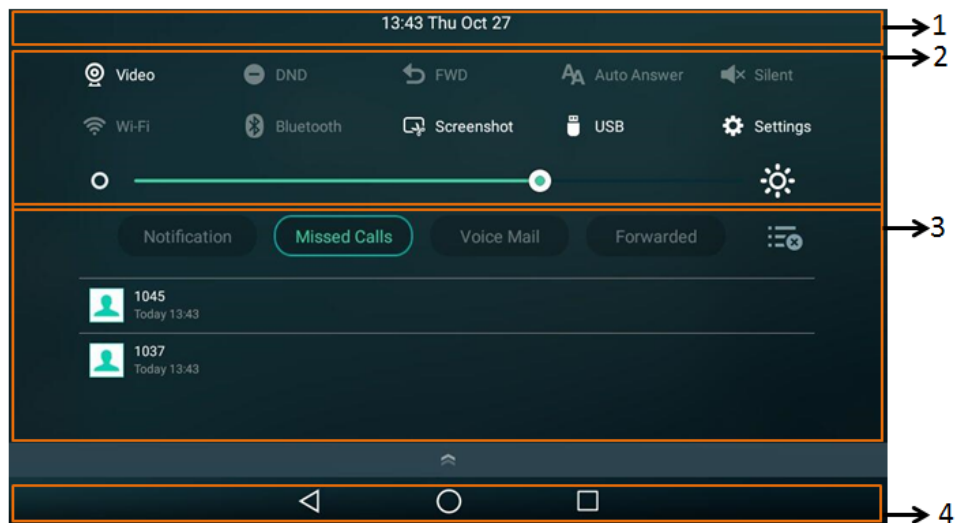

SIP-T58V/A

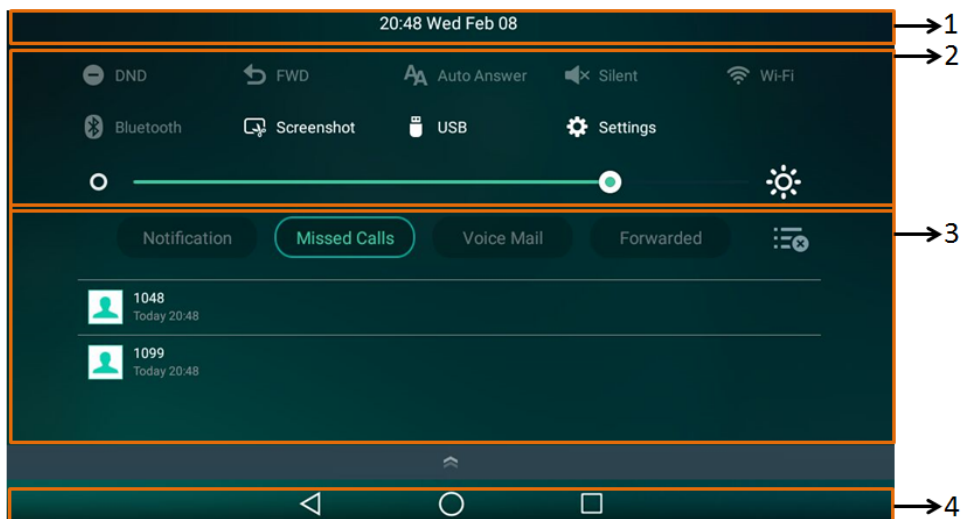

SIP-T56A

| No. | Name | Description |
|--|---------------------|---|
| 1 | Time and date | Display the phone's time and date. |
| 2 | Control Center | Video (Only for T58V/A) <ul style="list-style-type: none"> • Tap to access the Camera application when the IP phone is idle. • Tap to stop transmitting video during a video call. |
| | | DND <ul style="list-style-type: none"> • Tap to turn on/off DND feature quickly. |
| | | FWD <ul style="list-style-type: none"> • Tap to enter Call Forward setting screen. |
| | | Auto Answer <ul style="list-style-type: none"> • Tap to enter Auto Answer setting screen. |
| | | Silent <ul style="list-style-type: none"> • Tap to turn on/off silent feature quickly. |
| | | Wi-Fi <ul style="list-style-type: none"> • Tap to turn on/off Wi-Fi feature quickly. • Long tap to enter the Wi-Fi setting screen. |
| | | Bluetooth <ul style="list-style-type: none"> • Tap to turn on/off Bluetooth feature quickly. • Long tap to enter the Bluetooth setting screen. |
| | | Screenshot <ul style="list-style-type: none"> • Tap to capture a screenshot. |
| | | USB <ul style="list-style-type: none"> • Tap to access the File Manager application to manage the files in the USB flash drive. |
| | | Settings <ul style="list-style-type: none"> • Tap to enter the Settings screen. |
| Backlight Slider <ul style="list-style-type: none"> • Drag the slider to adjust the screen brightness quickly. You can also enter the Backlight setting screen to adjust the screen brightness. | | |
| 3 | Notification Center | <ul style="list-style-type: none"> • Tap Notification/Missed Calls/Voice Mail/Forwarded to view the corresponding notification list. • Tap the desired notification message to view the details. • Swipe left or right to delete a specific notification. • Tap  to delete all notifications. |
| 4 | Android Keys | <ul style="list-style-type: none"> ◁ : tap to go back to the previous screen. ○ : tap to return to the idle screen. □ : tap to view and manage the list of recently used applications. |

You can swipe up from the bottom of the screen to hide this screen.

Idle Screen

The smart media phone supports multiple idle screens. You can swipe left or right to switch among different idle screens. The IP phone supports three idle screens by default.

You can add a new idle screen by moving an application or widget to the right side of the third idle screen. The idle screen will be deleted automatically if there is no application or widget on the screen.

Topics

- [The Home Screen](#)
- [The Second Idle Screen](#)
- [The Third Idle Screen](#)

Related Topics

[Managing Applications and Widgets](#)

The Home Screen

The home screen displays as below:

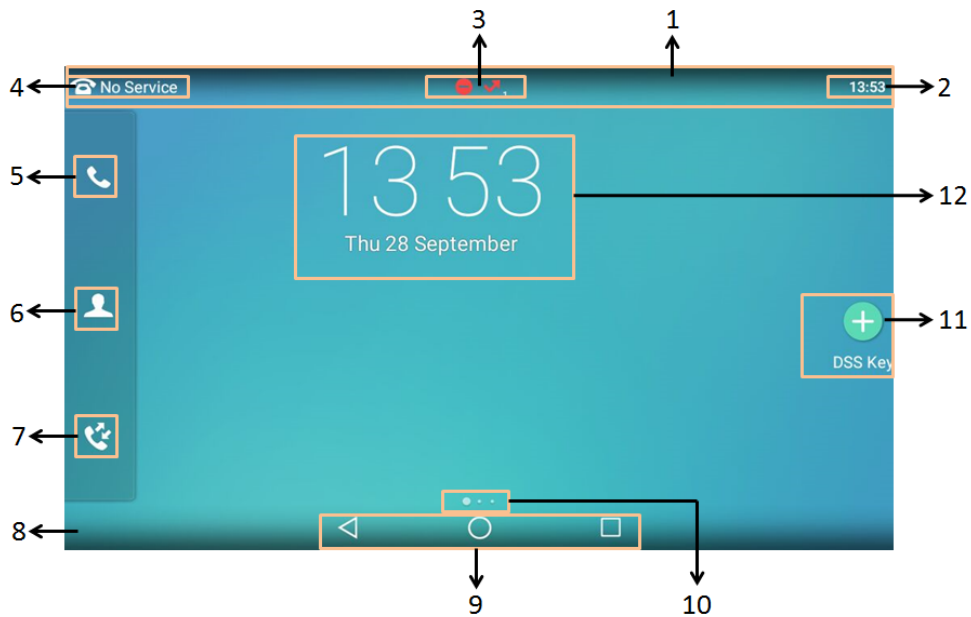

| No. | Name | Description |
|-----|------------------|--|
| 1 | Status Bar | Displays the phone's default account, icons and time. |
| 2 | Time | The phone's time is displayed on the right of the status bar. |
| 3 | Icons | Icons are displayed in the middle of the status bar. |
| 4 | Default account | The label of the default account is displayed on the left of the status bar. If there is no account registered on the IP phones, this field will display No Service . |
| 5 | Phone Dialer | Tap to enter the dialing screen. |
| 6 | Directory | Tap to enter the Directory screen and view contacts. |
| 7 | History | Tap to enter the History screen and view call history. |
| 8 | Wallpaper | Shows the specified wallpaper, which can be customized. |
| 9 | Android Keys | ◀ : tap to go back to the previous screen. ○ : tap to return to the idle screen. ◻ : tap to view and manage the list of recently used applications. |
| 10 | Screen Indicator | Indicates which idle screen is displayed. |
| 11 | DSS Key | Tap to add a line key, and then line key list will be displayed on the right of the home screen. |

| No. | Name | Description |
|-----|----------------------|-------------------------------------|
| 12 | Digital Clock Widget | Displays the phone's time and date. |

The Second Idle Screen

The second idle screen displays phone's system applications by default.

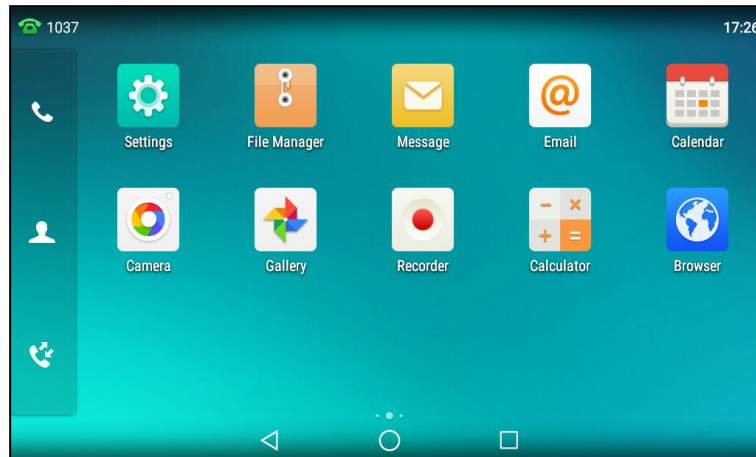

SIP-T58V/A

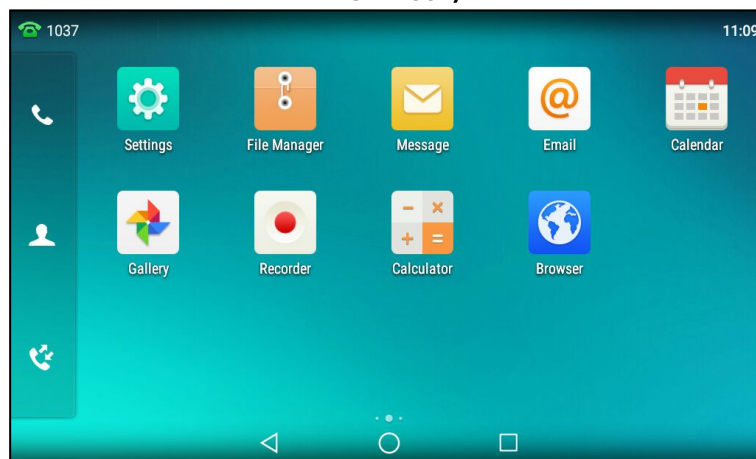

SIP-T56A

| No. | Application | Description |
|-----|-------------------------|--|
| 1 | Settings | To access phone settings and features. |
| 2 | File Manager | To manage files in the internal SD card as well as USB flash drive. |
| 3 | Message | To access the video/voice mails or leave video/voice mails for someone. |
| 4 | Email | To send and receive emails. |
| 5 | Calendar | You can use this application as a reminder or to manage and arrange your events. |
| 6 | Camera(only for T58V/A) | To take pictures or record videos. |
| 7 | Gallery | To view photos and videos. |

| No. | Application | Description |
|-----|-------------|---|
| 8 | Recorder | To record audio. |
| 9 | Calculator | To calculate. |
| 10 | Browser | To present and explore content on the World Wide Web. |

The Third Idle Screen

The third idle screen displays the calendar and email widgets by default.

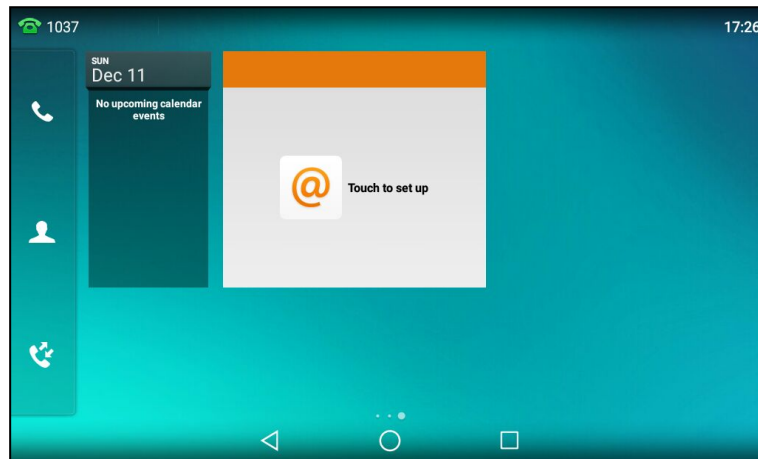

| No. | Widget | Description |
|-----|-----------------|--|
| 1 | Calendar Widget | Displays the data and upcoming events. |
| 2 | Email Widget | Displays email list of the specified folder. |

Configuration Screen

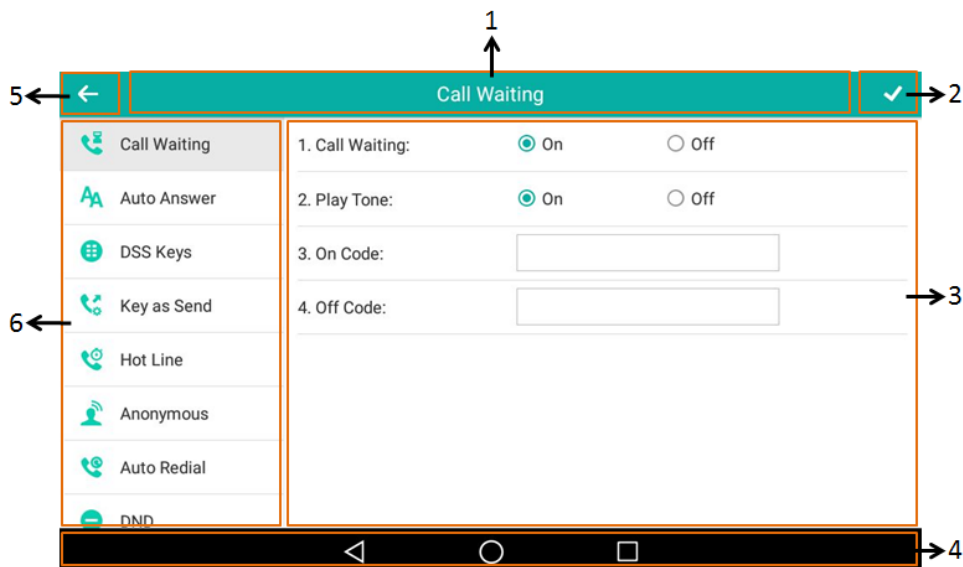

| No. | Name | Description |
|-----|--------------------|---|
| 1 | Title Area | Displays the title of the current menu screen. |
| 2 | ✓ | Tap to accept the settings. |
| 3 | Configuration Area | Displays configuration items of the highlighted menu item in the menu tree area. |
| 4 | Android Keys | <ul style="list-style-type: none"> ◁ : tap to go back to the previous screen. ○ : tap to return to the idle screen. □ : tap to view and manage the list of recently used applications. |
| 5 | ← | Tap to go back to the previous screen. |
| 6 | Menu Tree Area | <ul style="list-style-type: none"> • Displays menu items. • Tap the desired menu item to enter the corresponding configuration screen. |

Dialing/Pre-dialing Screen

When the phone is idle, you can pick up the handset, tap a line key, press the Speakerphone key or HEADSET key (if configured by your system administrator) to access the Dialing screen. Or you can enter a number directly using the keypad to access the Pre-dialing screen. From Dialing/Pre-dialing screen, the placed call records are displayed. You can also use the phone keypad to enter and edit data. The contacts whose name or phone number matches the entered characters appear on the phone screen. You can select the desired contact to place a call directly.

Note

Your system administrator can configure the search source list in dialing, and disable the phone to display the placed call records. Check with your system administrator to find out if they are available on your phone.

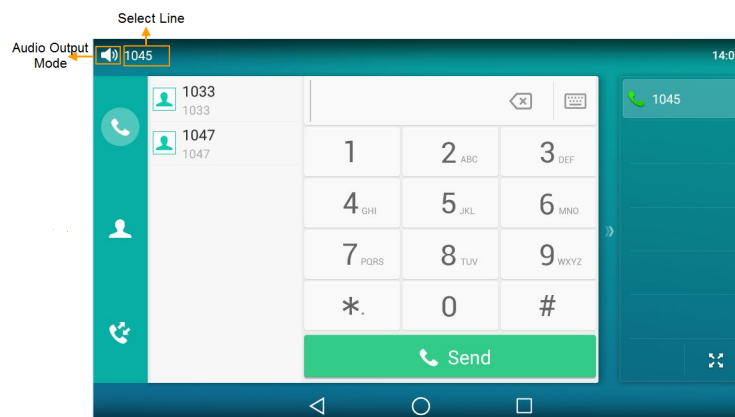



Video Call Screen



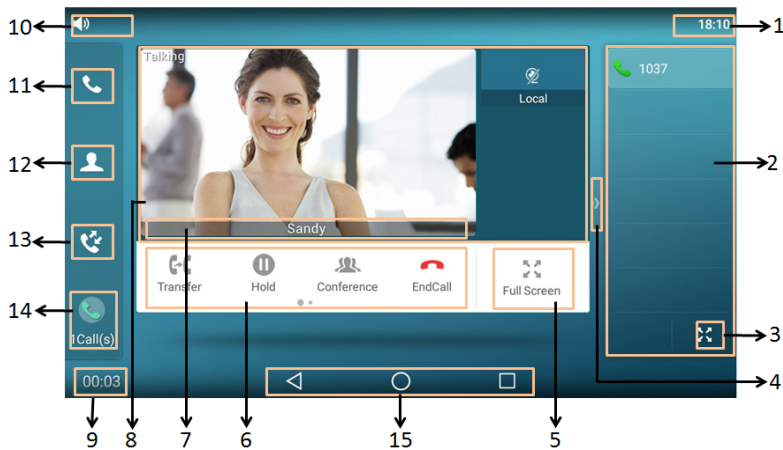

For SIP-T58V/A:











For SIP-T56A: SIP-T56A smart media phone is an audio phone, but the IP phone supports receiving video when answering a call made by a video-enabled party. You can see the far-site video, the far site cannot see you.



















| No. | Name | Description |
|-----|---|---|
| 1 | Time | The phone's time is displayed on the right of the status bar. |
| 2 | Line Key List | The line key list displays 6 line keys by default. You can drag up and down to scroll through the line keys. Various features can be assigned to line keys. Each line key can display the label and indicate the status of the assigned feature. Note: The line key list appears only if you have added at least one line key. |
| 3 |  | Tap to unfold line key list and display all line keys. |
| 4 |  | Tap it or swipe right to hide the line key list. |
| 5 | Full Screen | Tap to show the video on the phone in full screen. Only the near site(no video for SIP-T56A) and far site are shown. |
| 6 | Soft Keys | <ul style="list-style-type: none"> Label automatically to identify their context-sensitive features. Swipe left to see other soft keys. |
| 7 | Far-Site | Shows the information (name or number) of the far site. |

| No. | Name | Description |
|-----|---|---|
| | Information | |
| 8 | Active Call Window | Shows the video of far site and near site. By default, a small window (near site) is located on the top-right of the touch screen, and a larger window (far site) is centered in the middle of the touch screen. Note: If you do not connect the CAM50 to your SIP-T58V/A phone or turn off the near-site video during the call, the IP phone will stop transmitting the near-site video. Because the SIP-T56A IP phone cannot send video, the near-site video is turned off. |
| 9 | Call Duration Timer | Shows the duration time of current call. |
| 10 | Talking Mode | Shows that you are talking using the handset, speakerphone or headset. You can alternate among the three modes during calls. |
| 11 | Phone Dialer | Tap to enter the dialing screen. |
| 12 | Directory | Tap to enter the Directory screen and view contacts. |
| 13 | History | Tap to enter the History screen and view call history. |
| 14 |  | <ul style="list-style-type: none"> • A number under the icon indicates the number of call(s) on the phone. For example, 1 indicates that there is a call on the phone. • Tap to exit or return to the talking screen. |
| 15 | Android Keys | <ul style="list-style-type: none">  : tap to go back to the idle screen.  : tap to return to the idle screen.  : tap to view and manage the list of recently used applications. |

Icons in the Status Bar

| Icons | Description |
|---|--------------------------------|
|  | Wired network is unavailable |
|  | Speakerphone (hands-free) mode |
|  | Handset mode |
|  | Headset mode |
|  | Voice Mail |
|  | Auto Answer |
|  | Do Not Disturb (DND) |
|  | Keep Mute |

| Icons | Description |
|---|---|
|  | Silent Mode |
|  | Phone Lock |
|  (Only for T58) | Camera is not detected |
|  | Missed Calls |
|  | Call Forward |
|  | Bluetooth mode is on |
|  | Bluetooth headset is both paired and connected |
|  | Bluetooth-enabled mobile phone paired and connected |
|  | Wi-Fi mode is on |
|  | Wi-Fi signal strength from weak to strong after connecting successfully |
|  | The USB flash drive is detected |
|  | Screenshot captured |
|  | Downloading file |
|  | Uploading file |
|  | Upcoming alarm |
|  | Unread email |
|  | Phone Warning |

Line Key Icons







Icons on the line keys vary by phone models.

Icon indicators (associated with line key features):



| Icons | Description |
|---|--|
|  | Hold/Public Hold Private Hold |
|  | DND |
|  | Voice Mail |
|  | SMS |
|  | Direct Pickup |
|  | Group Pickup |
|  | DTMF Prefix |
|  | Local Group XML Group LDAP |
|  | XML Browser |
|  | Conference |
|  | Forward |
|  | Transfer |
|  | ReCall |
|  | Record URL Record |
|  | Recording in process (Record/URL Record) |
|  | Multicast Paging Group Listening Paging List |
|  | Hot Desking |
|  | Zero Touch |
|  | URL |
|  | Phone Lock |
|  | Directory |
|  | Speed Dial |

| Icons | Description |
|---|---------------|
|  | DECT Intercom |





Icon indicators (associated with line)

| Icons | Description |
|---|--|
|  | The private line registers successfully |
|  | The shared/bridged line registers successfully |
|  | Registering |
|  | Register failed |
|  | DND is enabled on this line |
|  | Call forward is enabled on this line |







Icon indicators (associated with a mobile account)

| Icons | Description |
|---|---|
|  | Bluetooth-Enabled mobile phone paired and connected |
|  | Bluetooth-Enabled mobile phone connection failed |
|  | Bluetooth-Enabled mobile phone connecting |

Icon indicators (associated with call park/retrieve park)





| Icons | Description |
|---|------------------------------|
|  | Park successfully/Idle state |
|  | Park failed |
|  | Ringing state |
|  | Retrieve parked call |

Icon indicators (associated with BLF/BLF List)





| Icons | Description |
|---|--|
|  | The monitored line is available. |
|  | The monitored line is ringing. |
|  | The monitored line is dialing. |
|  | The monitored line is busy or in a call. |
|  | The monitored line is placed on hold. |
|  | The monitored line is parked. |

| Icons | Description |
|---|---------------------------------|
|  | BLF/BLF List fails to register. |

Icon indicators (associated with intercom)











| Icons | Description |
|---|---|
|  | Target extension is available. |
|  | Target extension is ringing. |
|  | Target extension is dialing or in a call. |
|  | Target extension fails to register. |

Icon indicators (associated with ACD)





| Icons | Description |
|---|-------------|
|  | Log in |
|  | Available |
|  | Wrap up |
|  | Unavailable |
|  | Log out |

Icon indicators (associated with a shared line)

The Local SCA Phone is involved in an SCA call, while the Monitoring SCA Phone is not involved in the SCA call and used for monitoring shared line.

| Icons | Description |
|---|--|
|  | The shared line is idle. |
|  (Monitoring SCA Phone) | The shared line is seized. |
|  | The shared line receives an incoming call. |
|  | The shared line is dialing. |
|  | The shared line is in busy or is in a call. |
|  | The call on the shared line is placed on public hold. |
|  (Local SCA Phone)  (Monitoring SCA Phone) | The call on the shared line is placed on private hold. |
|  | The call on the shared line is barged in by the other shared line party. |
|  | In a multi-party call, all the participants place the call on hold. |







Call History Icons

| Icons | Description |
|---|-----------------|
|  | Received Calls |
|  | Placed Calls |
|  | Missed Calls |
|  | Forwarded Calls |

Navigating Menus and Fields

Procedure

- To navigate menus and fields, you can:
 - Tap corresponding keys on the touch screen.
 - Tap menu items, fields, and arrows on the touch screen.
 - Press keys on the phone keypad.
- To operate your phone using gestures, follow these tips:

| Gesture | | Action |
|-------------|---|---|
| Tap |  | Touch an item on the screen with your finger, and then lift your finger. |
| Long Tap |  | Touch an item for about 2 seconds without lifting your finger from the screen till an action occurs. |
| Swipe |  | Touch and move. When you want to scroll quickly, swipe your finger across the screen, either up, down, left or right. |
| Drag |  | Touch and hold, then move. To stop scrolling, stop the dragging motion. |
| Pinch Open |  | Touch the screen with two or more fingers, and then move the fingers away from each other (stretch). |
| Pinch Close |  | Touch the screen with two or more fingers, and then move the fingers towards each other (pinch). |

Entering Characters

The phone provides onscreen keyboard, phone keypad and onscreen dial pad to enter data. Phone keypad and onscreen dial pad provide a standard key layout, which enables users to use existing or familiar key positions.

Topics









[Using the Onscreen Keyboard](#)

[Using the Phone Keypad and Dial Pad](#)

Using the Onscreen Keyboard

Before using the onscreen keyboard to enter data, you need to know the function of the keys on the onscreen keyboard. The phone supports two kinds of input methods: English (UK) and Google Pinyin.

When you use the onscreen keyboard, the other following things you need to know:

| If you want to | Action |
|-----------------------------------|--|
| Position the cursor. | Tap to position. |
| Select all characters. | <ol style="list-style-type: none"> 1. Long tap the entered character(s). 2. Do one of the following: <ul style="list-style-type: none"> • Tap SELECT ALL on the top of the touch screen. • Drag  /  to select all characters. |
| Cut/Copy characters. | <ol style="list-style-type: none"> 1. Long tap the entered character(s). 2. Drag  /  to select the characters you want to cut/copy. 3. Tap CUT /COPY on the top of the touch screen. 4. Long tap the desired field. 5. Tap PASTE. |
| Delete more characters at a time. | <ul style="list-style-type: none"> • Long tap the entered character(s). • Drag  /  to select the characters you want to delete. • Tap  . • Long tap  . |
| Replace characters. | <ol style="list-style-type: none"> 1. Drag your finger to highlight the characters you want to replace. 2. Tap the desired character. |

Related Topic

[Changing the Input Method](#)

Topics





[English \(UK\) Input Method](#)

[Google Pinyin Input Method](#)

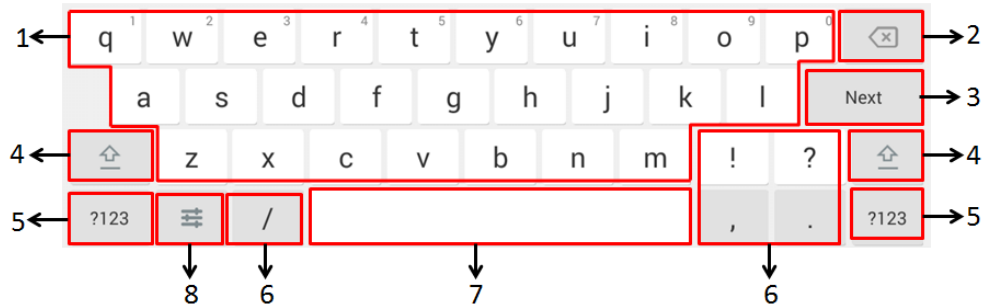
English (UK) Input Method

You can use the English keyboard of the English (UK) input method to enter information.



| No. | Item | Description |
|-----|---|---|
| 1 | 26 English Letters | <ul style="list-style-type: none"> Tap to enter letters. Long tap a key then slide to choose one of the options to enter an alternate character. |
| 2 | Delete Key | <ul style="list-style-type: none"> Tap to delete the entered characters one by one. Long tap to delete two or more characters. |
| 3 | Label automatically to identify the context-sensitive features. | Next Key Tap to go to the next field. |
| | | Done Key Tap to confirm the settings. |
| | | Send Key Tap to dial out the number. |
| | | Go Key Tap to browse the web page. |
| 4 |  | Tap to switch to the uppercase input mode. |
| 5 |  | Tap to switch to the numeric&symbolic input mode. |
| 6 | Five Special Characters | Tap to enter the corresponding character. |
| 7 | Space Key | <ul style="list-style-type: none"> Tap to enter spaces. Long tap to change the input method. <p>Tip: You can also tap  at the bottom right corner of the touch screen to change input method.</p> |
| 8 |  | Tap to access input options to configure Input languages or Android Keyboard Settings (AOSP). You can use AOSP to configure Android keyboard including Input languages, Auto-capitalization, Sound on keypress and so on. |

Tap  to switch to the numeric&symbolic input mode as shown below:

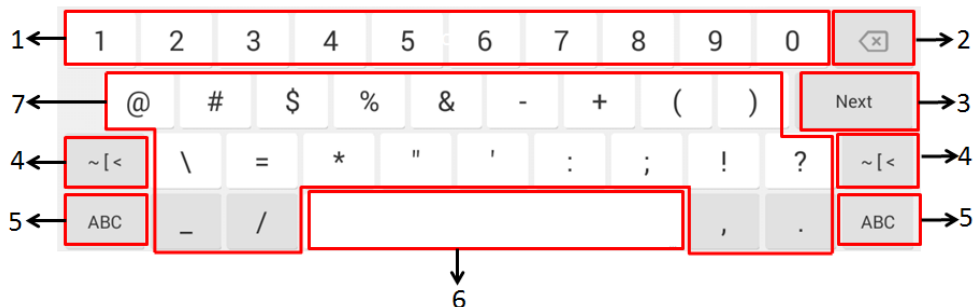

| No. | Item | Description | |
|-----|---|---|------------------------------|
| 1 | Numbers | <ul style="list-style-type: none"> • Tap to enter numbers. • Long tap a key then slide to choose one of the options to enter an alternate character. | |
| 2 | Delete Key | <ul style="list-style-type: none"> • Tap to delete the entered characters one by one. • Long tap to delete two or more characters. | |
| 3 | Label automatically to identify the context-sensitive features. | Next Key | Tap to go to the next field. |
| | | Done Key | Tap to confirm the settings. |
| | | Send Key | Tap to dial out the number. |
| | | Go Key | Tap to browse the web page. |
| 4 | ~ [< | Tap to switch to the symbolic input mode. | |
| 5 | ABC | Tap to switch to the lowercase input mode. | |
| 6 | Space Key | <ul style="list-style-type: none"> • Tap to enter spaces. • Long tap to change the input method. <p>Tip: You can also tap  at the bottom right corner of the touch screen to change input method.</p> | |
| 7 | Special Characters | <ul style="list-style-type: none"> • Tap to enter special characters. • Long tap a key then slide to choose one of the options to enter an alternate character. | |

Tap ~ [< to switch to the symbolic input mode as shown below:

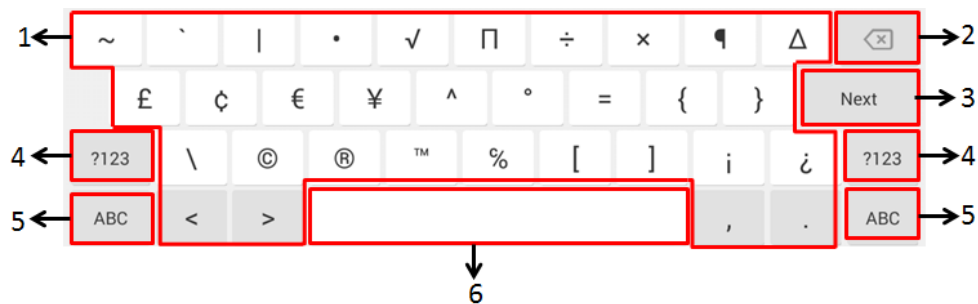

| No. | Item | Description | |
|-----|---|---|------------------------------|
| 1 | Special Characters | <ul style="list-style-type: none"> • Tap to enter special characters. • Long tap a key then slide to choose one of the options to enter an alternate character. | |
| 2 | Delete Key | <ul style="list-style-type: none"> • Tap to delete the entered characters one by one. • Long tap to delete two or more characters. | |
| 3 | Label automatically to identify the context-sensitive features. | Next Key | Tap to go to the next field. |
| | | Done Key | Tap to confirm the settings. |
| | | Send Key | Tap to dial out the number. |
| | | Go Key | Tap to browse the web page. |

| No. | Item | Description |
|-----|-----------|---|
| 4 | ?123 | Tap to switch to the numeric&symbolic input mode. |
| 5 | ABC | Tap to switch to the lowercase input mode. |
| 6 | Space Key | <ul style="list-style-type: none"> • Tap to enter spaces. • Long tap to change the input method. <p>Tip: You can also tap  at the bottom right corner of the touch screen to change the input method.</p> |

Google Pinyin Input Method

You can use Google Pinyin input method (谷歌拼音输入法) to enter Chinese characters.

When you change the input method to Google Pinyin, the onscreen keyboard displays the English input mode as shown below by default:

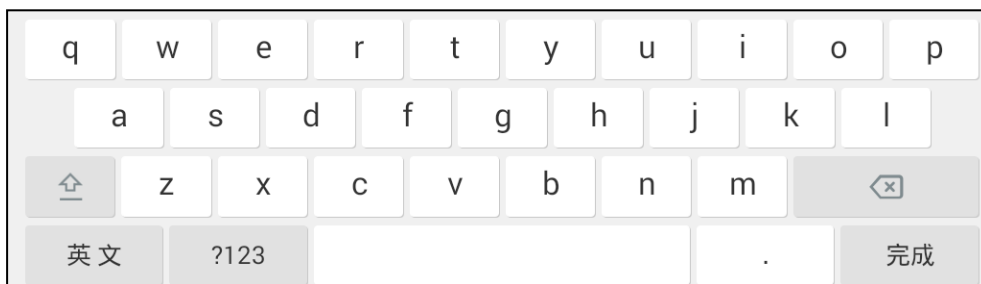

Tap **英文** to switch to the Chinese input mode as shown below:



Tap **?123** to switch to the numeric&symbolic input mode as shown below:

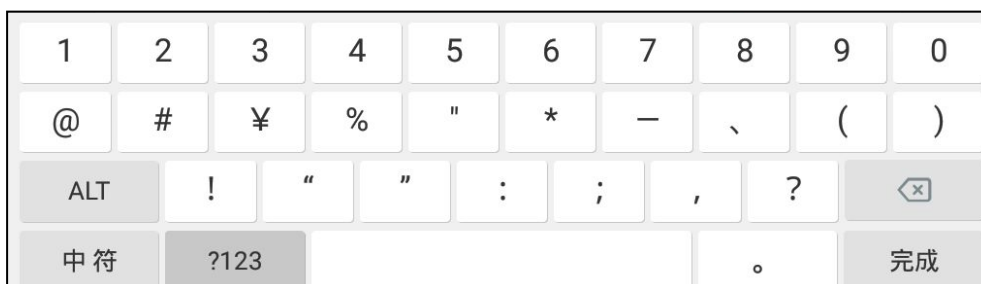

Tap **ALT** to switch to the symbolic input mode as shown below:

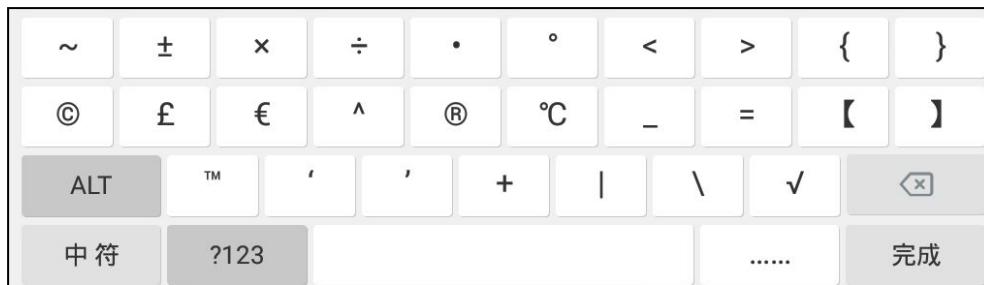

Using the Phone Keypad and Dial Pad

You can use the keypad on your phone or dial pad on the dialing screen to enter data. The onscreen dial pad only provides digit keys, # key and * key.

You can tap  to use the onscreen keyboard.

Related Topic

[Using the Onscreen Keyboard](#)

Customizing Your Phone

You can make your IP phone more personalized by customizing various settings.

Topics

[Changing the Administrator Password](#)
[Wallpaper](#)
[Screen Saver](#)
[Changing the Screen Backlight Brightness and Time](#)
[Changing the Language](#)
[Changing the Input Method](#)
[Time & Date](#)
[Setting a Key as Send](#)
[Phone Lock](#)
[Line Keys](#)
[Wireless Network](#)
[Bluetooth](#)

Changing the Administrator Password

Some features on the phone can be set from the Advanced Settings only. By default, you require an administrator password to access the Advanced Settings. The default password is "admin".

For security reasons, you should change the default password as soon as possible. If you do not change the default password, the phone displays a warning icon in the status bar.

Procedure

1. Swipe left or right to go to the second idle screen.
2. Navigate to **Settings**->**Advanced Settings**->**Set Password**.
3. Enter the desired value in the **Old PWD**, **New PWD** and **Confirm PWD** field respectively.
4. Tap  .

Related Topic

[Investigating Warnings](#)

Wallpaper

The IP phone comes with a default picture, you can change it to another built-in picture. You can also add personal pictures as wallpapers using a USB flash drive.

Note

You can also use a custom picture uploaded by your system administrator as the wallpaper.

Topics

[Changing Wallpaper on Idle Screen](#)
[Adding a Wallpaper from a USB Flash Drive](#)

Changing Wallpaper on Idle Screen

Procedure

1. Swipe left or right to go to the second idle screen.
2. Navigate to **Settings**->**Basic Settings**->**Display**->**Wallpaper**.
3. Select **Gallery** or **Wallpapers**, and then select the desired wallpaper image.
4. Tap **Set wallpaper**.

Adding a Wallpaper from a USB Flash Drive

When USB flash drive is connected to your phone, the picture in USB flash drive can be shown in the album. You can set a picture in USB flash drive as wallpaper using the **Gallery** application.

The SIP-T58V/A and SIP-T56A smart media phone screen size is 7 inches (Resolution: 1024x600).

We recommend that you add a picture that meets the size of the custom picture. Either the smaller or larger picture will be scaled proportionally to fit the screen.

Tip

You can also set a picture in USB flash drive as wallpaper using the **File Manager** application.

Related Topic

[Setting a Picture as Wallpaper](#)

Screen Saver

The screen saver starts automatically when the IP phone has been idle for the preset waiting time. You can stop the screen saver at any time by pressing any key. When your phone is idle again after a preset waiting time, the screen saver starts again. By default, your screen displays a built-in picture when the screen saver starts.

Topics

[Changing the Waiting Time for Screen Saver](#)

[Setting the Screen Saver Type](#)

Changing the Waiting Time for Screen Saver

You can change the waiting time for the screen saver.





Procedure

1. Swipe left or right to go to the second idle screen.
2. Navigate to **Settings**->**Basic Settings**->**Display**->**Screen Saver**.
3. Select the desired waiting time from the **Screensaver Waiting Time** field.
4. Tap  .

Setting the Screen Saver Type

The IP phone supports four screen saver types: **Clock**, **Colours**, **Photo Frame** and **Photo Table**.

Procedure

1. Swipe left or right to go to the second idle screen.
2. Navigate to **Settings**->**Basic Settings**->**Display**->**Screen Saver**.
3. Select the desired screen saver type.
 - If you select **Clock**, tap  next to the radio box. Select the desired **Style** and **Night mode** for the screen saver type.
 - If you select **Photo Frame**, tap  next to the radio box to select the desired Gallery album(s).
 - If you select **Photo Table**, tap  next to the radio box to select the desired Gallery album(s).
4. Tap  .

Changing the Screen Backlight Brightness and Time

You can change the backlight brightness of the touch screen during phone activity and inactivity. The backlight brightness automatically changes when the phone is idle for a specified time.

You can change the screen backlight brightness and time in the following settings:

Backlight Active Level: The intensity of the touch screen when the phone is active.

Backlight Time: The delay time to change the brightness of the touch screen when the phone is inactive. Backlight time includes the following settings:

- **Always On:** Backlight is on permanently.
- **15s, 30s, 1min, 2min, 5min, 10min or 30min:** Backlight is changed when the phone is inactive after the designated time (in seconds).

Topics

[Changing the Backlight and Time on Idle Screen](#)

[Changing the Backlight on Control Center](#)

Changing the Backlight and Time on Idle Screen

Procedure

1. Swipe left or right to go to the second idle screen.
2. Navigate to **Settings**->**Basic Settings**->**Display**->**Backlight**.
3. Drag the **Backlight Active Level** slider to change the intensity of the touch screen.
4. Select the desired value from the **Backlight Time** field.
5. Tap  .

Related Topic

[Changing the Backlight on Control Center](#)

Changing the Backlight on Control Center

Procedure

1. Swipe down from the top of the screen to enter the control center.

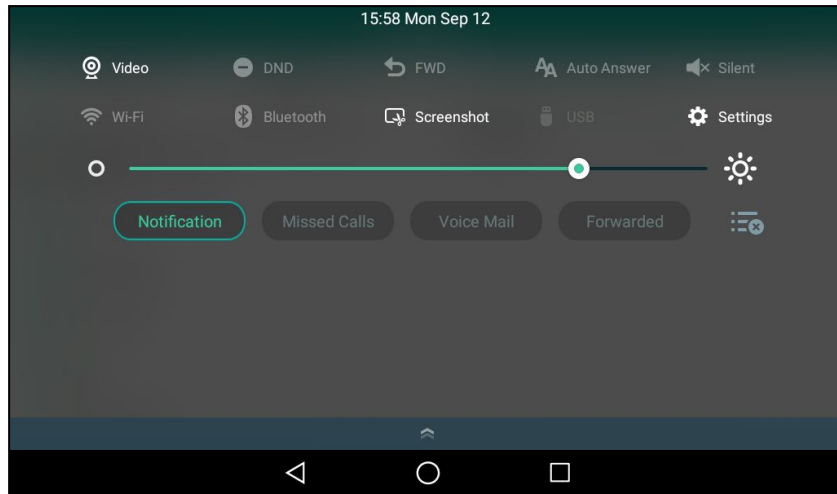

SIP-T58V/A

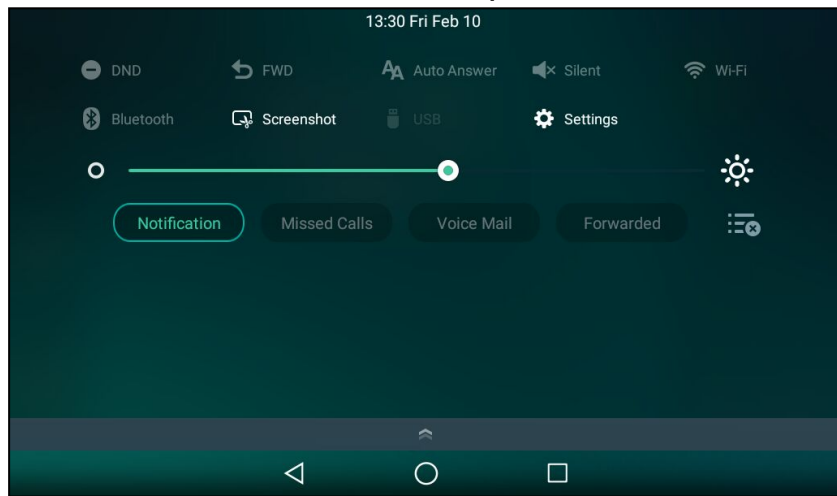

SIP-T56A



2. Do one of the following:

- Drag the backlight slider.

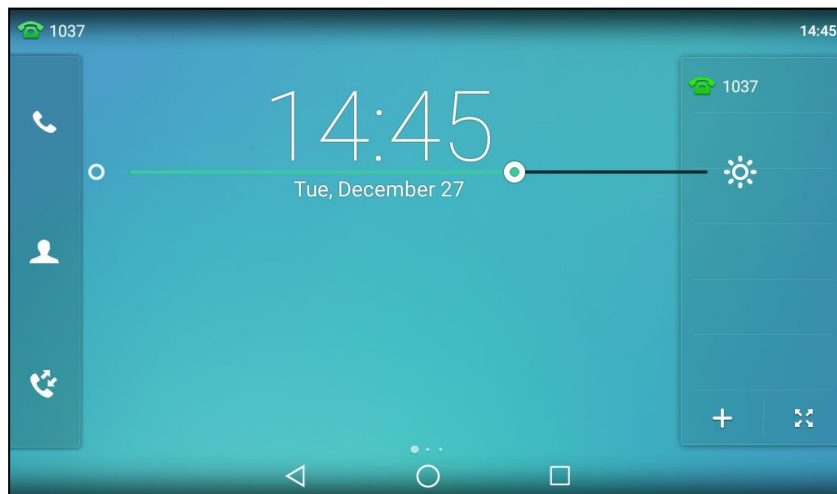
When dragging the slider, the control center (except the backlight slider) and notification center will be hidden. You can view the intensity changes of the touch screen in real-time.



If you lift your finger, the control center and notification center will be shown again.

- Tap  .
The intensity of the touch screen is changed to the highest.
- Tap  .
The intensity of the touch screen is changed to the lowest.

Related Topic

[Changing the Backlight and Time on Idle Screen](#)

Changing the Language

The default phone language is English. You can change the phone language.

Procedure

1. Swipe left or right to go to the second idle screen.
2. Navigate to **Settings->Basic Settings->Language & Input->Language**.
2. Select the desired language.
3. Tap  .

The phone language is changed to the selected one.

Changing the Input Method

The phone supports two kinds of input methods: Android Keyboard (AOSP) - English (UK) and 谷歌拼音输入法. The default input method is English (UK). You can change the currently used input method.

Procedure

1. Swipe left or right to go to the second idle screen.
2. Navigate to **Settings->Basic Settings->Language & Input->Current Input**.
3. Tap the desired input method in the pop-up dialog.

You can also long tap the following keys on the onscreen keyboard to change the input method.

For Android Keyboard (AOSP) - English (UK) input method:

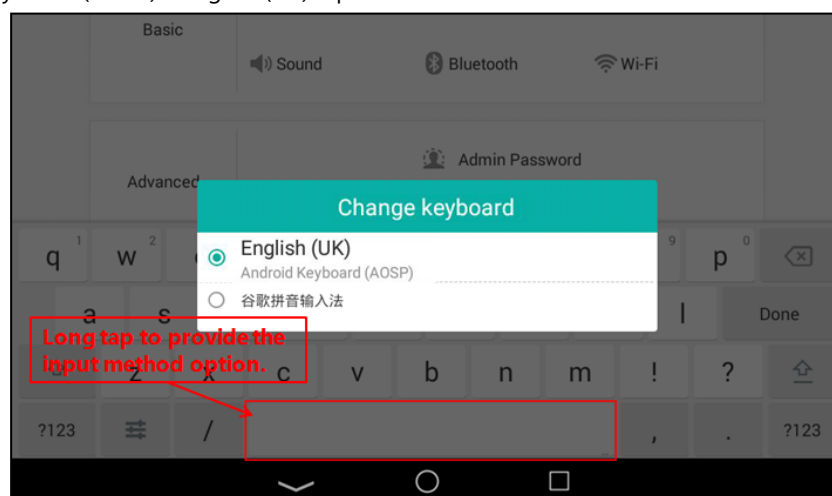

For 谷歌拼音输入法:

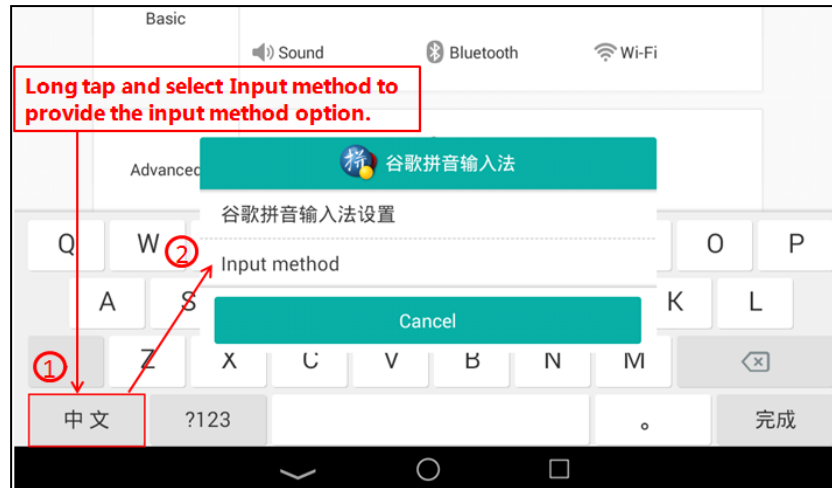

Time & Date

You can set the time and date manually. The time and date formats are also customizable.

Topics

[Setting the Time and Date Manually](#)
[Changing the Time and Date Format](#)

Setting the Time and Date Manually

If your phone cannot obtain the time and date automatically, you can set it manually.

Before You Begin

Check with your system administrator to find out if the manual mode has been enabled.

Procedure

1. Swipe left or right to go to the second idle screen.
2. Navigate to **Settings**->**Basic Settings**->**Time & Date**->**General**.
3. Enter the date and time in the corresponding fields.
4. Tap .

The time and date set on the phone will be changed accordingly.

Changing the Time and Date Format

You can customize the date with various time and date formats.

The built-in date formats are listed as below:

| Date Format | Example (2016-09-02) |
|-------------|----------------------|
| WWW MMM DD | Fri Sep 02 |
| DD-MMM-YY | 02-Sep-16 |
| YYYY-MM-DD | 2016-09-02 |

| Date Format | Example (2016-09-02) |
|-------------|----------------------|
| DD/MM/YYYY | 02/09/2016 |
| MM/DD/YY | 09/02/16 |
| DD MMM YYYY | 02 Sep 2016 |
| WWW DD MMM | Fri 02 Sep |

Note

Your system administrator can customize the date format.

Procedure

1. Swipe left or right to go to the second idle screen.
2. Navigate to **Settings**->**Basic Settings**->**Time & Date**->**Time & Date Format**.
2. Select the desired date format from the **Date Format** field.
3. Select the desired time format from the **Time Format** field.
4. Tap  .

Setting a Key as Send

You can set the “#” key or “*” key to perform as a send key while dialing.

Procedure

1. Swipe left or right to go to the second idle screen.
2. Navigate to **Setting**->**Features**->**Key As Send**.
2. Select # or * from the **Key As Send** field, or select **Disabled** to disable this feature.
3. Tap  .

Phone Lock

Phone lock helps you protect your phone from unauthorized use. You can lock your phone manually when you are not using it. The phone is also locked automatically after being idle for a specified time.

Topics

[Phone Lock and Waiting Time](#)

[Setting the Phone Lock](#)

[Locking Your Phone Manually](#)

[Unlocking Your Phone](#)

[Changing Your Phone Unlock PIN](#)

Phone Lock and Waiting Time

When the phone is locked, All keys and screen are locked except the HEADSET key, Volume key, digit keys, # key, * key and Speakerphone key. You are only allowed to:

- Dial emergency numbers.
- Reject incoming calls.

- Answer incoming calls.
- End the call

You can set a waiting time to lock your phone automatically. If the waiting time is set to 0, the phone will not be automatically locked. You need to lock your phone manually.

Related Topic

[Setting the Phone Lock](#)

Setting the Phone Lock

By default, the phone lock feature is disabled. If you want to lock your phone, you need to enable this feature. You can specify the waiting time to lock your phone automatically.

Procedure

1. Swipe left or right to go to the second idle screen.
2. Navigate to **Settings**->**Advanced Settings** (default password: admin) ->**Phone Lock**.
3. Select **Enabled** from the **Lock Enable** field.
4. Enter the desired interval (0 - 3600 seconds) in the **Auto Lock** field.
5. Tap .

Related Topic

[Phone Lock and Waiting Time](#)

Locking Your Phone Manually

If you have specified a timeout to lock your phone automatically, your phone will be locked after being idle for a specified time. You can also lock your phone manually.

Before You Begin

Make sure that the phone lock is enabled.

Procedure

1. Long # key to lock your phone immediately on the idle screen.
- When the phone is locked, the lock icon appears on the phone screen.

Related Topic

[Setting the Phone Lock](#)

Unlocking Your Phone

Procedure

1. Tap the screen or tap the locked key, the phone screen prompts you to enter a unlock PIN.
2. Enter the desired PIN (default: 123) in the **Unlock PIN** field.
3. Tap **OK**.

The lock icon disappears from the phone screen.

Note

If you forget the unlock PIN, you can enter the administrator password to unlock your phone, and then change the unlock PIN.

Changing Your Phone Unlock PIN

The default unlock PIN is 123, you can change it at any time for security reasons.

Procedure

1. Swipe left or right to go to the second idle screen.
2. Navigate to **Settings**->**Basic Settings**->**Change PIN**.
2. Enter the desired value in the **Old PIN**, **New PIN** and **Confirm PIN** field respectively.
The unlock PIN length must be within 15 digits.
3. Tap ✓ .

Line Keys

You can assign predefined functionalities to line keys. You can also define a label for a line key feature which will appear on the touch screen. Line keys allow you to quickly access features such as recall and voice mail. The line key can indicate the monitored status when the line keys are assigned with particular features, such as BLF. The default key type of line key 1-16 is Line. The default key type of line key 17-27 is N/A, which indicates that this line key provides no functionality until configuration.

Topics

- [Assigning Functionality to a Line Key](#)
- [Changing the Location of the Line Keys](#)
- [Deleting a Line Key](#)

Assigning Functionality to a Line Key

Procedure

1. Do one of the following:
 - When there is no line key configured, tap  on the home screen.

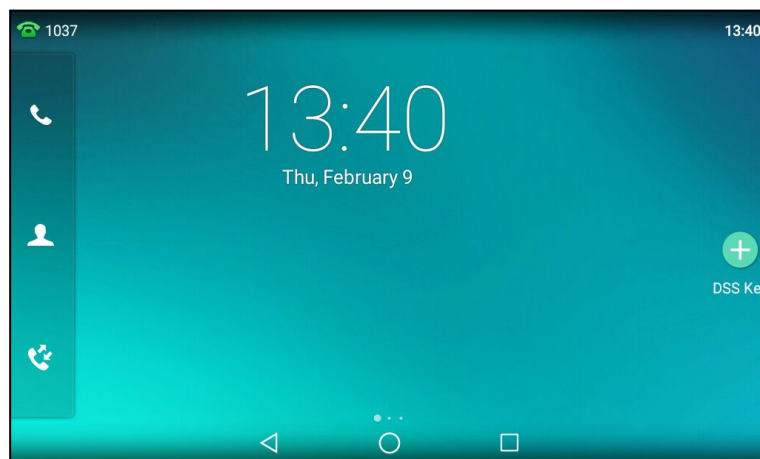

- When there is at least a line key configured, tap  on the bottom-left of the line key list.

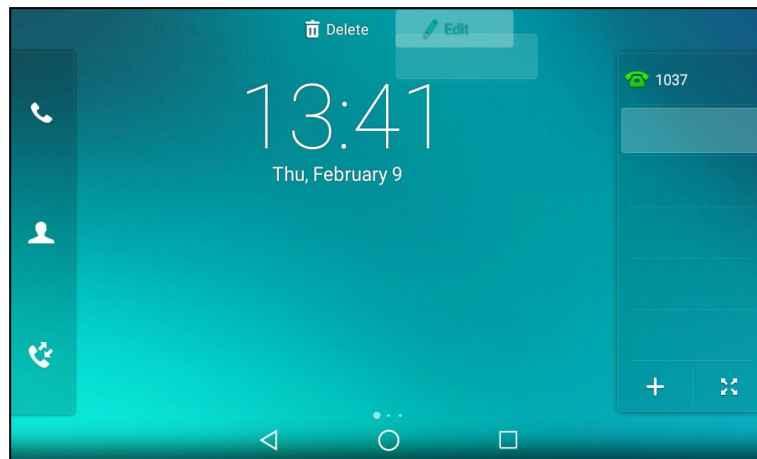

- Swipe down from the top of the screen or swipe left/right to go to the second idle screen, and then navigate to **Settings->Features->Dsskey**.
Tap the desired line key.
- 2. Select the desired key type from the **Type** field.
- 3. Configure the settings for the corresponding key type.
For example, if you want to a line key for intercom, configure the **Account ID**, **Label**, **Value**, and **Extension** for the line key.
- 4. Tap .

Changing the Location of the Line Keys

You can change the line key's location to a blank area on the Line keys field. You can also change the location of two line keys. And the operating instructions are almost the same. The following takes how to change the location of two line keys as an example.

Procedure

1. Do one of the following:
 - Drag up and down to scroll through the line keys list if required.
 - Tap  on the bottom-right of the line key list.
2. Drag a line key to the desired location at which another line key locates.
For example, exchange the locations of line key 1 and line key 2:

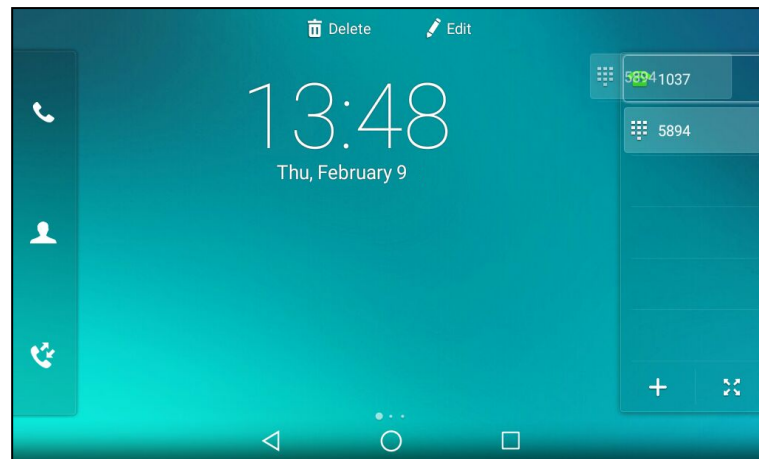

The following shows the locations of two line keys after exchange:

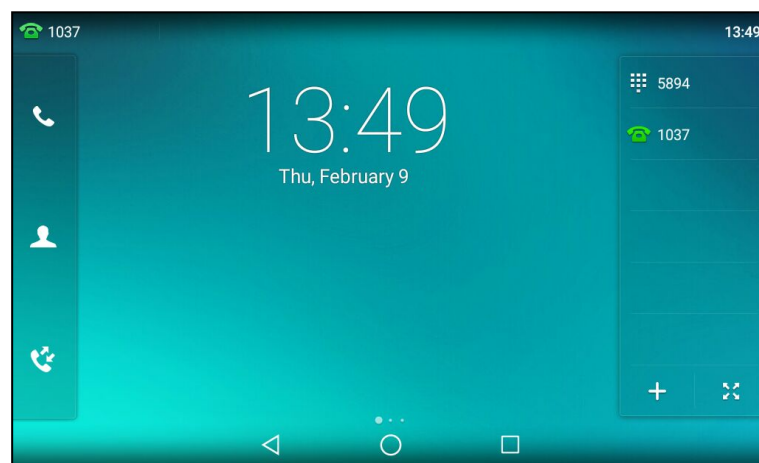

Deleting a Line Key

Procedure

1. Drag the desired line key to the **Delete** field.

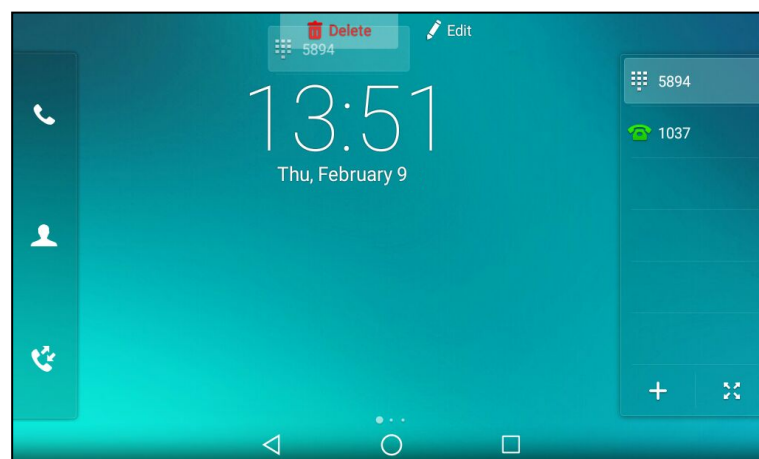

The phone screen prompts you whether to delete the DSS key.

3. Tap **OK**.

Wireless Network

Yealink IP phone supports Wi-Fi feature. The IP phone can be connected to the wireless network if Wi-Fi is available within the area. For more information, contact your system administrator.

Note

Enabling Bluetooth may degrade your wireless network connection. For improved wireless network performance, you should disable Bluetooth when it is not in use. To deactivate the Bluetooth mode, refer to [Deactivating the Wi-Fi Mode](#).

Topics

[Activating the Wi-Fi Mode](#)

[Deactivating the Wi-Fi Mode](#)

[Connecting to the Wireless Network](#)

[Viewing the Wireless Network Information](#)

[Disconnecting the Wireless Network Connection](#)

Activating the Wi-Fi Mode

Procedure

1. Do one of the following:
 - Swipe down from the top of the screen to enter the control center.
 - Swipe left/right to go to the second idle screen, navigate to **Settings**->**Basic Settings**->**Wi-Fi**.
2. Turn on the Wi-Fi.

The IP phone scans the available wireless networks in your area.

The touch screen displays the Wi-Fi icon.

Deactivating the Wi-Fi Mode

You should deactivate the Wi-Fi mode when you need to connect your phone to the wired network.

Procedure

1. Do one of the following:
 - Swipe down from the top of the screen to enter the control center.
 - Swipe left/right to go to the second idle screen, navigate to **Settings**->**Basic Settings**->**Wi-Fi**.
2. Turn off the Wi-Fi.

The Wi-Fi icon disappears from the status bar.

Connecting to the Wireless Network

Three ways to connect smart media phone to the wireless network:

- Manually connect to an available wireless network
- Wi-Fi Protected Setup (WPS)
- Manually add a wireless network

When the phone is connected to a wireless network, the Wi-Fi icon  will display on the status bar.

Topics

[Connecting to an Available Wireless Network Manually](#)

[Connecting to the Wireless Network Using Wi-Fi Protected Setup \(WPS\)](#)

[Adding a Wireless Network Manually](#)

Connecting to an Available Wireless Network Manually

Before You Begin

Get the password of the wireless network from your system administrator. Make sure that the Wi-Fi mode is activated.

Procedure

1. Swipe left or right to go to the second idle screen.
2. Navigate to **Settings**->**Basic Settings**->**Wi-Fi**.
The phone will automatically search for available wireless networks in your area.
3. (Optional.) To re-search the available network, tap  and then tap **Scan**.
4. Tap the desired wireless network (SSID) to connect to it.
5. If the network is secure, enter its password in the **Password** field.

You can do the following:

- Tap the **Show password** radio box to make the password visible.
- Tap the **Show advanced options** radio box to configure the HTTP proxy for the **Browser** application.

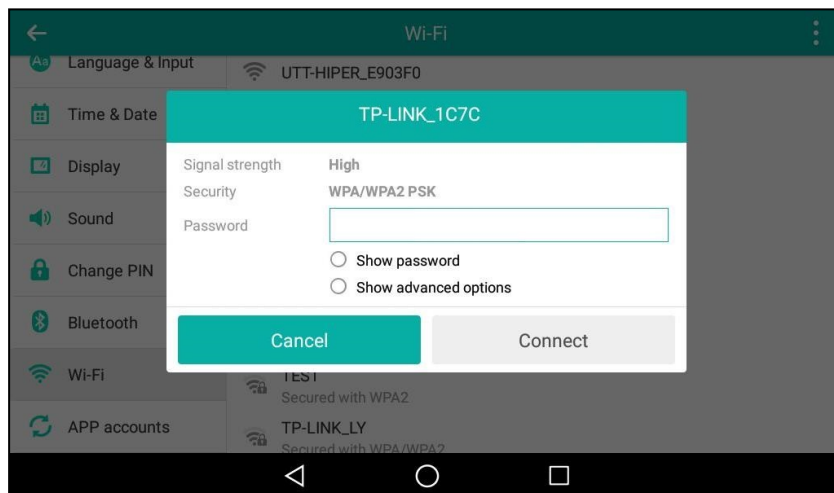

6. Tap **Connect** to connect to the wireless network.

Once the connection has completed successfully, the prompt "Connected" appears under the corresponding SSID.

Related Topic

[Activating the Wi-Fi Mode](#)

Connecting to the Wireless Network Using Wi-Fi Protected Setup (WPS)

Wi-Fi Protected Setup (WPS) provides simplified mechanisms to configure secure wireless networks. WPS can automatically configure a wireless network with a network name (SSID) and strong WPA data encryption and authentication.

Two methods supported by Yealink IP phones in the Wi-Fi protected setup:

- **Push Button Configuration (PBC):** The user simply has to push the WPS key on both the IP phone and gateway/router to connect.

- **Personal Identification Number (PIN):** The user has to enter a WPS PIN generated randomly by the IP phone on the gateway/router to connect.

Before You Begin

Make sure that the Wi-Fi mode is activated.

Push Button Configuration (PBC)

Procedure

1. Swipe left/right to go to the second idle screen.
2. Navigate to **Settings->Basic Settings->Wi-Fi**.
3. Tap  and then tap **WPS**.
The touch screen prompts "Press the Wi-Fi Protected Setup button on your router. It may be called "WPS" or contain this symbol:".
4. Long press the WPS key on your gateway/router.
Once WPS setup has completed successfully, the touch screen will prompt "Connected".

Personal Identification Number (PIN)

Procedure

1. Swipe left/right to go to the second idle screen.
2. Navigate to **Settings->Basic Settings->Wi-Fi**.
3. Tap  and then tap **WPS-PIN**.
The touch screen prompts "Enter pin XXX on your Wi-Fi router. The setup can take up to two minutes to complete.".
4. Note the PIN code.
5. Log into your gateway/router's web interface, and configure it to search the clients. For more information, refer to the documentation from the gateway/router manufacturer.
Once the WPS-PIN setup has completed successfully, the gateway/router's web interface will prompt success.

Adding a Wireless Network Manually

If your gateway/router has SSID broadcast disabled, it might not appear in the scanning results. In that case, you must manually add a wireless network.

Before You Begin

Get the available wireless network information from your system administrator. Make sure that the Wi-Fi mode is activated.

Procedure

1. Swipe left or right to go to the second idle screen. Navigate to **Settings->Basic Settings->Wi-Fi**.
2. Tap  ->**Add**.

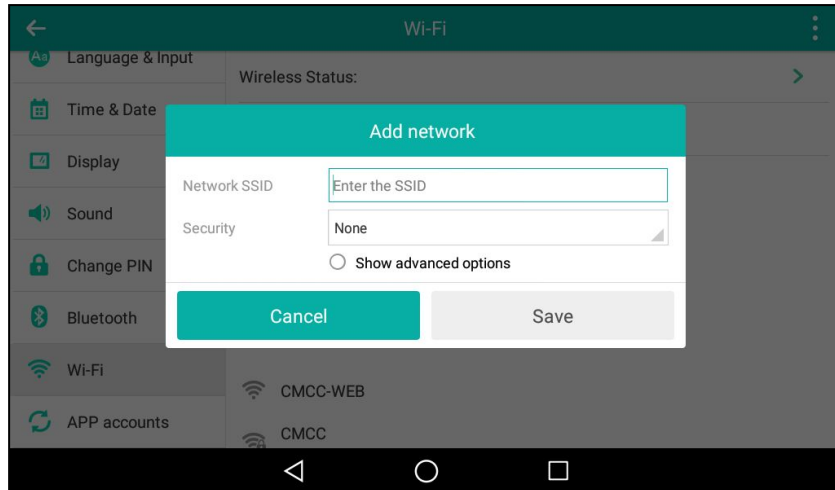

3. Enter the desired value in the **Network SSID** field.
4. Tap the **Security** field.
5. Tap the desired value.
 - If you select **WEP** or **WPA/WPA2 PSK**, enter the password in the **Password** field:
 - If you select **802.1x EAP**, tap the **EAP method** field, select the desired EAP method and then enter the desired values in the corresponding fields.
6. Do the following:
 - Tap the **Show password** radio box to make the password visible.
 - Tap the **Show advanced options** radio box to configure the HTTP proxy for the **Browser** application.
7. Tap **Save**.

Viewing the Wireless Network Information

Procedure

1. Swipe left or right to go to the second idle screen.
2. Navigate to **Settings**->**Basic Settings**->**Wi-Fi**.
3. Tap **Wireless Status** to view the detailed wireless network information (e.g., Profile Name, SSID or Signal Strength).

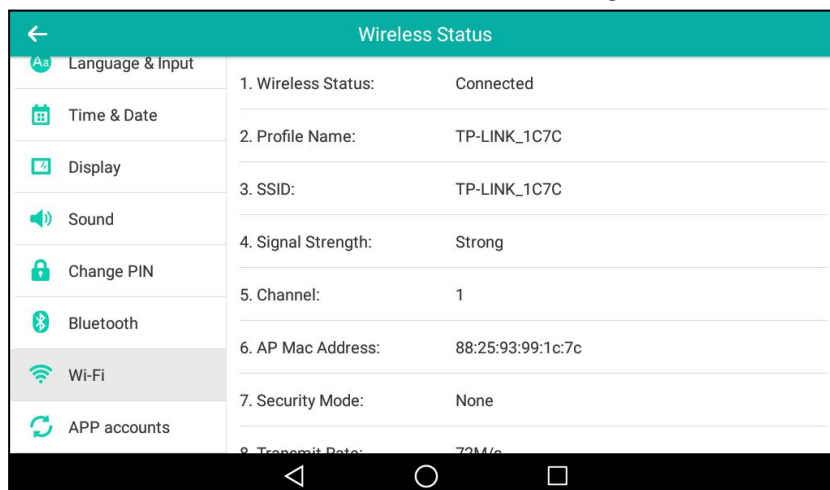

4. (Optional.) Drag up and down to scroll through the list of wireless network information.

Disconnecting the Wireless Network Connection

You can disconnect the wireless network connection from your phone.

Procedure

1. Swipe left or right to go to the second idle screen.
2. Navigate to **Settings**->**Basic Settings**->**Wi-Fi**.
3. Tap the connected SSID (the top one).

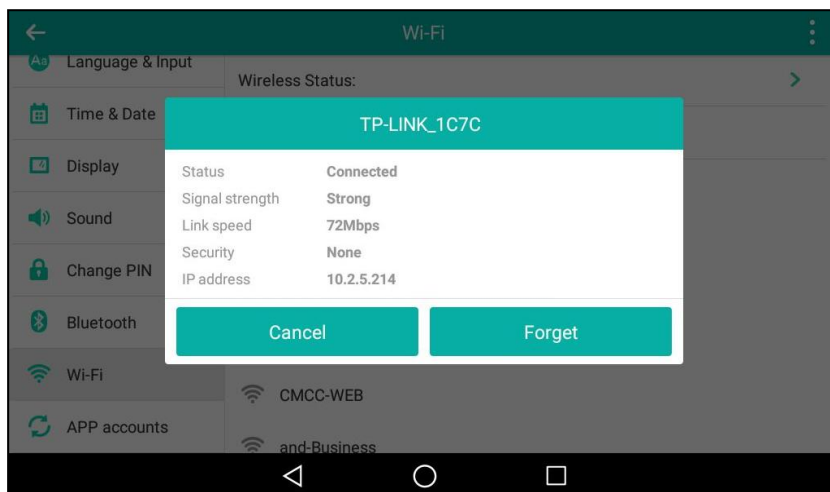

4. Tap **Forget**.

You can also disconnect the wireless network by deactivating the Wi-Fi mode.

Related Topic

[Deactivating the Wi-Fi Mode](#)

Bluetooth

The IP phone supports Bluetooth. Bluetooth enables low-bandwidth wireless connections within a range of 10 meters (32 feet). The best performance is in the 1 to 2 meters (3 to 6 feet) range.

You can activate/deactivate the Bluetooth mode, and then pair and connect the Bluetooth device with your phone. You can pair up to countless Bluetooth devices with your phone; however, only one Bluetooth device can be connected at a time. You can also share files with friends via Bluetooth.

You can pair and connect a Bluetooth headset/speakerphone/microphone or a Bluetooth-enabled mobile phone to your IP phone. And the Bluetooth operating instructions on different Bluetooth devices are the same.

Topics

[Activating the Bluetooth Mode](#)

[Deactivating the Bluetooth Mode](#)

[Pairing and Connecting the Bluetooth Headset](#)

[Pairing and Connecting the Bluetooth-Enabled Mobile Phone](#)

[Configuring the Phone Audio Feature](#)

[Configuring the Media Audio Feature](#)

[Syncing the Mobile Contacts to the IP Phone](#)

[Handling a Mobile Phone Call on the IP Phone](#)

[Editing Device Name of your Phone for Recognition](#)

[Making the Phone Discoverable](#)

[Renaming the Paired Bluetooth Device](#)

[Sending Files via Bluetooth](#)

[Receiving Files via Bluetooth](#)

[Unpairing the Bluetooth Device](#)

[Disconnecting the Bluetooth Device](#)

Activating the Bluetooth Mode

Procedure

1. Do one of the following:
 - Swipe down from the top of the screen to enter the control center.
 - Swipe left/right to go to the second idle screen, navigate to **Settings**->**Basic Settings**->**Bluetooth**.
2. Turn on the Bluetooth.

The IP phone scans the available Bluetooth device automatically.

The touch screen displays the Bluetooth icon.

Deactivating the Bluetooth Mode

You can deactivate the Bluetooth mode when you no longer use a Bluetooth device.

Procedure

1. Do one of the following:
 - Swipe down from the top of the screen to enter the control center.
 - Swipe left/right to go to the second idle screen, navigate to **Settings**->**Basic Settings**->**Bluetooth**.
2. Turn off the Bluetooth.

The Bluetooth icon disappears from the status bar.

Pairing and Connecting the Bluetooth Headset

Before You Begin

Make sure that the Bluetooth headset is discoverable.

Procedure

1. Swipe left/right to go to the second idle screen.
 2. Navigate to **Settings**->**Basic Settings**->**Bluetooth**.
 3. Tap  to search for the Bluetooth device.
 4. Tap the desired Bluetooth headset to connect to your phone.
- The connection will be completed successfully with a prompt appears under the Bluetooth headset name.

The Bluetooth icon  appears on the status bar.

Related Topic

[Activating the Bluetooth Mode](#)

Pairing and Connecting the Bluetooth-Enabled Mobile Phone

You can only connect one Bluetooth device at a time. After connection, the IP phone will automatically find an available line key and assign the line key for Mobile Account. The Mobile Account key's default label is "My Mobile". If there is no available line key, you may assign it manually.

Before You Begin

Make sure that the Bluetooth-Enabled mobile phone is discoverable.

Procedure

1. Swipe left/right to go to the second idle screen.
2. Navigate to **Settings**->**Basic Settings**->**Bluetooth**.
3. Tap  to search for the Bluetooth-Enabled mobile phone.
4. Tap the desired Bluetooth-Enabled mobile phone to connect to the mobile phone.
5. Tap **Pair** on both mobile phone and IP phone.

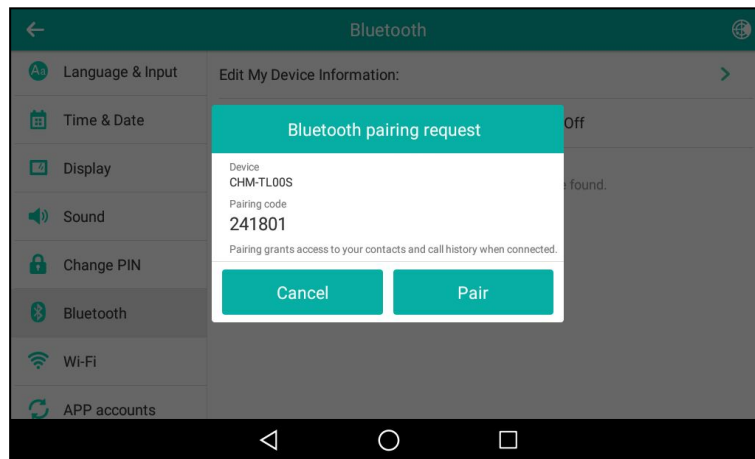

Then the IP phone will prompt "Would you like to sync phone contacts temporarily?".

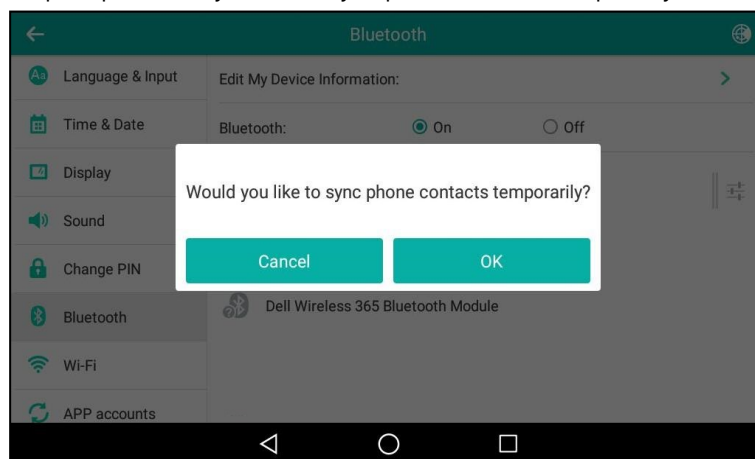

6. Tap **OK** to enable the mobile contacts sync feature and the IP phone will sync the mobile contacts temporarily, or tap **Cancel** to disable mobile contacts sync feature.

The connection will be completed successfully with a prompt appears under the Bluetooth-Enabled mobile phone name.

And the IP phone automatically assigns a Mobile Account key.

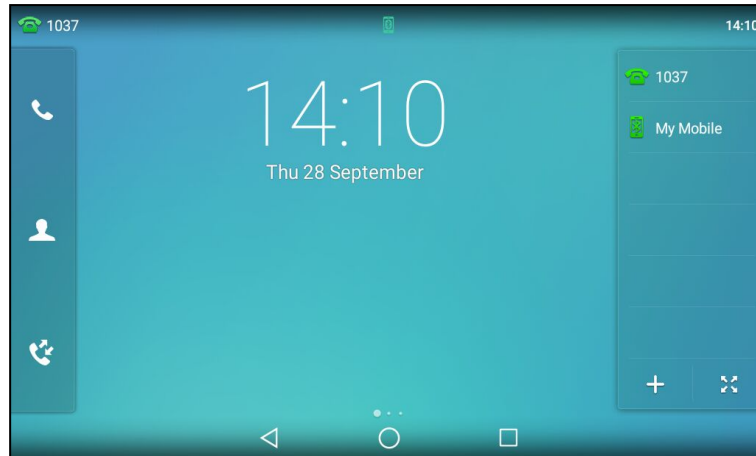
**Note**

If you enable mobile contacts sync feature, you also need to authorize the IP phone to sync the contacts temporarily on the mobile phone.

Related Topics

[Activating the Bluetooth Mode](#)

[Syncing the Mobile Contacts to the IP Phone](#)



Configuring the Phone Audio Feature

After connecting your Bluetooth-Enabled mobile phone, you can synchronize mobile phone contacts to SIP phones, and make or place a mobile phone call on the SIP phone. The SIP phone act as a hands-free device of Bluetooth-Enabled mobile phone, though the call is made through your mobile phone, the mobile call can be handling on the phone.

If connecting a Bluetooth headset, you can choose whether to answer a call using the Bluetooth headset.

If you want to enable the mobile contacts sync feature, you should enable the phone audio feature first.

Procedure

1. Swipe left or right to go to the second idle screen.
2. Navigate to **Settings**->**Basic Settings**->**Bluetooth**.
3. Tap  after the desired Bluetooth device name.
4. Mark the **Phone audio** radio box.
5. Tap .

Related Topic



[Pairing and Connecting the Bluetooth-Enabled Mobile Phone](#)

Configuring the Media Audio Feature

After connecting your Bluetooth headset, you can stream SIP phone audio to Bluetooth headset. That is, the Bluetooth headset acts as the SIP phone player.

To use this feature, you need to enable the Media Audio feature.

Procedure

1. Navigate to **Settings**->**Basic Settings**->**Bluetooth**.
2. Tap  after the connected Bluetooth headset name.
3. Turn on **Media audio**.
4. Tap .

Related Topic

Syncing the Mobile Contacts to the IP Phone

You can sync mobile contacts to your IP phone. This is a convenient way to view a contact without accessing your mobile phone.

Note

Not all mobile phones support syncing the mobile contacts to IP phone. For more information, contact your system administrator.

Topics

[Enabling the Mobile Contacts Sync Feature](#)

[Viewing Your Mobile Contacts on the IP Phones](#)

[Disabling the Mobile Contacts Sync Feature](#)

Enabling the Mobile Contacts Sync Feature

Before You Begin

Make sure that the Bluetooth-Enabled mobile phone is paired and connected to your IP phone and the phone audio feature is enabled.

Procedure

1. Swipe left or right to go to the second idle screen.
2. Navigate to **Setting**->**Basic Settings**->**Bluetooth**.
3. Tap  after the desired Bluetooth-Enabled mobile phone name.
4. Mark the **Mobile Contacts Sync** radio box.
You need to authorize the IP phone to synchronize the contacts temporarily on the mobile phone first, and then the mobile contacts directory will appear in the IP phone directory list.

Related Topics

[Pairing and Connecting the Bluetooth-Enabled Mobile Phone](#)

[Configuring the Phone Audio Feature](#)

Viewing Your Mobile Contacts on the IP Phones

Before You Begin

Make sure that the mobile contact sync feature is enabled.

Procedure



1. Navigate to  ->**Mobile Contacts**.

Related Topic

[Enabling the Mobile Contacts Sync Feature](#)

Disabling the Mobile Contacts Sync Feature

Procedure

1. Swipe left/right to go to the second idle screen.
2. Navigate to **Setting**->**Basic Settings**->**Bluetooth**.
3. Tap  after the desired Bluetooth-Enabled mobile phone name.
4. Cancel the mark of the **Mobile Contacts Sync** radio box.
5. Tap .

The mobile contacts directory will disappear from the IP phone directory list.

Note

The mobile contacts directory also disappears from the IP phone directory list after deactivating the Bluetooth mode.

Related Topic

[Deactivating the Bluetooth Mode](#)

Handling a Mobile Phone Call on the IP Phone

You can handle a mobile phone call on your IP phones, the IP phone acts as a hands-free device for your mobile phone.

The call information appears on both your IP phone and mobile phone screen. You can control the call's audio to go through the mobile phone or IP phone on your mobile phone. If you choose Bluetooth, the audio will go through the IP phone; if you choose Handset earpiece or Speaker, the audio will go through the mobile phone.

Before You Begin

Make sure that the Bluetooth-Enabled mobile phone is paired and connected to your IP phone and the phone audio feature is enabled.

Procedure

1. Do the following on the phone:
 - Place a call. Tap the **My Mobile** line key first, and then place a call or multiple calls to the mobile contact.
 - Answer a call. An incoming call to your mobile phone is also shown on the IP phones, you can answer the call on the IP phone. The phone will firstly match the contacts in the mobile contacts directory to present the caller-/callee identity when receiving/placing a mobile phone call.
 - During the call, you can hold/resume, mute/unmute or end the call on the IP phone.

Related Topics

[Pairing and Connecting the Bluetooth-Enabled Mobile Phone](#)

[Configuring the Phone Audio Feature](#)

[Placing Calls](#)

[Answering Calls](#)

[Ending Calls](#)

[Call Mute](#)

[Call Hold](#)

Editing Device Name of your Phone for Recognition

You can edit the device name of your phone to display in scanning list of other Bluetooth devices.

Before You Begin

Make sure that the Bluetooth mode is activated.

Procedure

1. Swipe left or right to go to the second idle screen.
2. Navigate to **Setting**->**Basic Settings**->**Bluetooth**->**Device Name**.
3. Enter the desired name in the **Device Name** field.
4. Tap  .

Related Topics

[Activating the Bluetooth Mode](#)

[Making the Phone Discoverable](#)

Making the Phone Discoverable

If you make your IP phone discoverable to other Bluetooth devices, the other Bluetooth devices can scan and find your IP phone.

Before You Begin

Make sure you have activated the Bluetooth mode.

Procedure

1. Swipe left or right to go to the second idle screen.
2. Navigate to **Setting**->**Basic Settings**->**Bluetooth**->**Edit Device information**.
3. Tap the **On** radio box in the **Open Discover** field.

Related Topic

[Activating the Wi-Fi Mode](#)

Renaming the Paired Bluetooth Device

Before You Begin

You have paired and connected the Bluetooth device.

Procedure

1. Swipe left/right to go to the second idle screen.
2. Navigate to **Settings**->**Basic Settings**->**Bluetooth**.
The touch screen shows the paired and connected Bluetooth device.
3. Tap  after the connected Bluetooth device name.
4. Enter the desired device name in the **Rename** field.

5. Tap .

The configured Bluetooth device name will display in the **PAIRED DEVICES** list on your phone. The Bluetooth device name displayed in the scanning list of other devices will not be changed.

Note

The icon  only appears after the device name of the Bluetooth device that you are connecting or have connected.

Related Topic

[Pairing and Connecting the Bluetooth-Enabled Mobile Phone](#)

Unpairing the Bluetooth Device

You can unpair your Bluetooth device and your phone. When you unpair the Bluetooth device, it disappears from the **PAIRED DEVICES** list.

Procedure

1. Swipe left/right to go to the second idle screen.
2. Navigate to **Settings**->**Basic Settings**->**Bluetooth**.
The touch screen shows the paired and connected Bluetooth device.
3. Tap  after the connected Bluetooth device name.
4. Tap **Unpair**.

Sending Files via Bluetooth

The **Gallery** and **File Manager** applications support sending files via Bluetooth. You can send pictures, videos or audios to a Bluetooth-enabled mobile phone or other Bluetooth devices displayed in the **AVAILABLE DEVICES** list.

Related Topics

[Sharing Pictures/Videos via Bluetooth](#)

[Sharing Pictures/Videos/Audios via Bluetooth](#)

Receiving Files via Bluetooth

The Bluetooth-enabled mobile phone or other Bluetooth devices can share files with your IP phone. The file type is not restricted, you can receive pictures, audios, videos, documents, and so on. You can use the corresponding system applications to view the files. You can only receive files from the Bluetooth devices displayed in the in the **AVAILABLE DEVICES** list.

Procedure

1. Share a file with the IP phone on your Bluetooth device.
The IP phone will play a notification sound, and the touch screen prompts "Accept incoming file?".

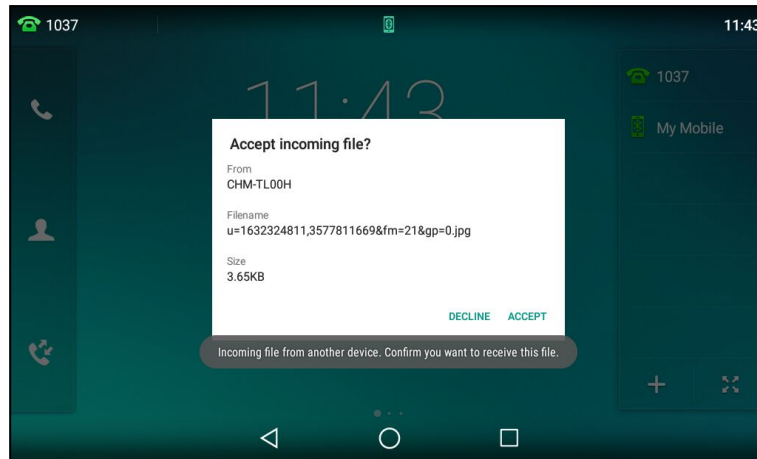

2. Tap **Accept** to start receiving the file.

The touch screen prompts "The file will be received. Check progress in the Notification panel.". The icon  will display on the status bar.

3. (Optional.) Swipe down from the top of the screen to enter the notification center.

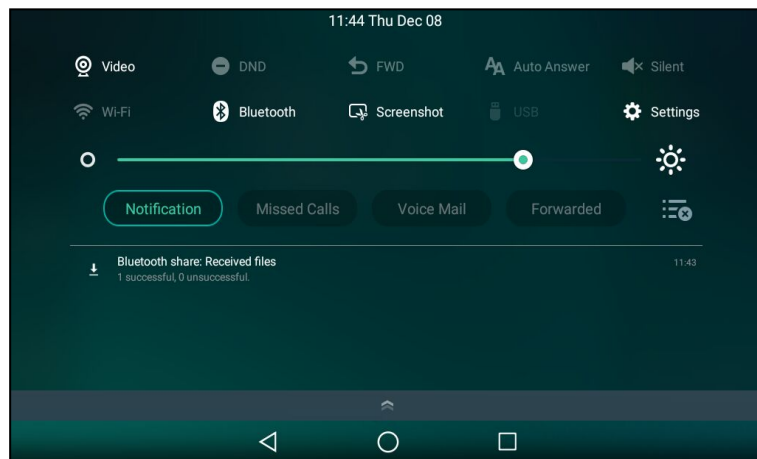

Tap the notification "Bluetooth share: Received file".

You can use the corresponding system applications to view the file.

Disconnecting the Bluetooth Device

Procedure

1. Swipe left/right to go to the second idle screen.
2. Navigate to **Settings**->**Basic Settings**->**Bluetooth**.
3. Tap the connected Bluetooth device.

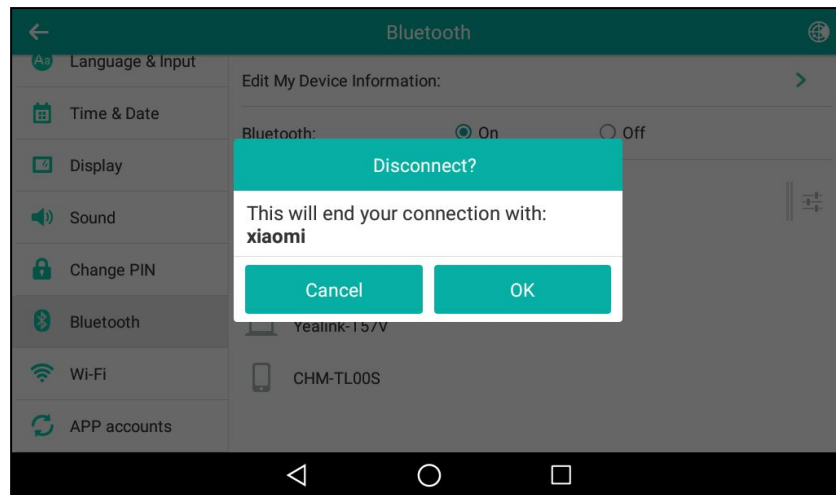

4. Tap **OK**.

The Bluetooth device is disconnected.

Audio Settings

The audio settings contain the volume settings, and the available ring tone and key tone settings. You can also enable touch sounds, silent mode or configure notification sound on the phone.

Topics

[Adjusting the Volume](#)

[Setting the Ring Tone](#)

[Setting the Key Tone](#)

[Enabling Touch Sounds](#)

[Configuring Notification Sound](#)

[Enabling Silent Mode](#)

Adjusting the Volume

You can adjust the audio volume and the ring volume.

Topics

[Adjusting the Audio Volume](#)

[Adjusting the Ringer Volume](#)

[Adjusting the Media Volume](#)

Adjusting the Audio Volume

When you are playing an audio file (for example, call recording), choosing a ring tone or during a call, you can increase or lower the volume of the currently engaged audio devices (handset, speakerphone or headset).

Procedure

1. Press the Volume key to adjust the audio volume.

Related Topics

[Setting a Ring Tone for the Phone](#)

[Setting a Ring Tone for an Account](#)

[Setting a Ring Tone for a Group](#)

[Setting a Ring Tone for a Contact](#)

[Playing a Recorded Call](#)

Adjusting the Ringer Volume

When the phone is idle or ringing, you can increase or decrease the ringer volume. If ringer volume is adjusted to the minimum, the minimum volume icon will appear on phone screen.

Procedure

1. Press the Volume key to adjust the ringer volume.

Adjusting the Media Volume

You can adjust the media volume in multiple scenarios. For example, when playing audio files in the **File Manager** or **Recorder** application.

Procedure

1. Press the Volume key to adjust the media volume.

The volume slider appears, you can also drag the volume slider to adjust the media volume.

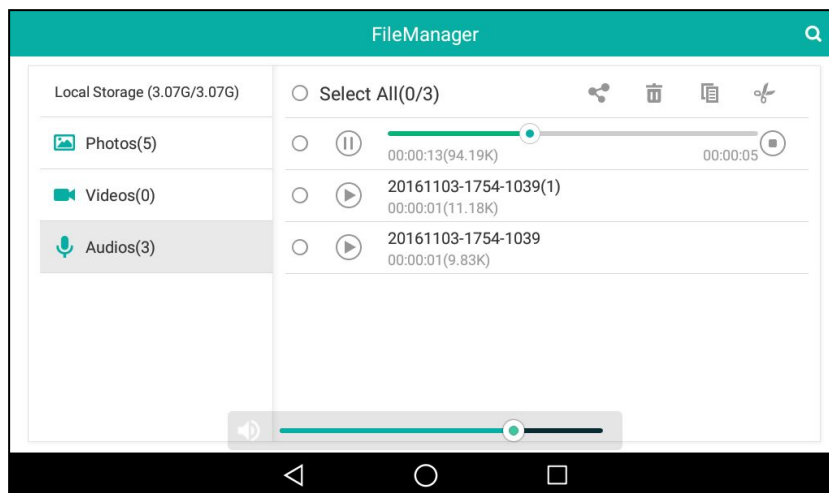

Setting the Ring Tone

You can choose from a variety of ring tones to distinguish your phone from your neighbor's. You can set distinctive ring tones for groups or contacts in your local directory, so you can identify the caller when your phone rings.

You can also choose a unique ring tone for different accounts on your phone.

The ring tones are used according to this priority: Contact ring tone>Group ring tone>Account ring tone >Phone ring tone.

Note

You can also choose a custom ring tone uploaded by your system administrator.

Topics

- [Setting a Ring Tone for the Phone](#)
- [Setting a Ring Tone for an Account](#)
- [Setting a Ring Tone for a Group](#)
- [Setting a Ring Tone for a Contact](#)

Setting a Ring Tone for the Phone

You can choose a ring tone for all incoming calls.

Procedure

1. Swipe left or right to go to the second idle screen.
2. Navigate to **Settings->Basic Settings->Sound->Ring Tones->Common**.
2. Select the desired ring tone.

The ring tone is played automatically. You can press the Volume key to adjust the ringtone volume.

3. Tap  .

Related Topic

[Adjusting the Audio Volume](#)

Setting a Ring Tone for an Account

You can select a unique ring tone for an individual account.

Procedure

1. Swipe left or right to go to the second idle screen.
2. Navigate to **Settings**->**Basic Settings**->**Sound**->**Ring Tones**.
3. Select the desired account.
4. Select the desired ring tone.
The ring tone is played automatically. You can press the Volume key to adjust the ringtone volume.
If **Common** is selected, this account will use the ring tone selected for the phone.
5. Tap  .

Related Topic

[Adjusting the Audio Volume](#)

Setting a Ring Tone for a Group



You can select a unique ring tone for various groups in your local directory. This helps you quickly identify callers according to the ring tones.

By default, the **Auto** is selected, this means that the group uses the ring tone according to this priority: Contact ring tone>Account ring tone>Phone ring tone. If a specific ring tone is selected, this group will use the ring tone according to this priority: Contact ring tone>Group ring tone.

Note

You can only set a ring tone for a group that is added manually.

Procedure

1. Tap  ->**Settings**.
2. Tap  after the desired group.
3. Tap the desired ring tone in the pop-up dialog box.
The ring tone is played automatically. You can press the Volume key to adjust the ringtone volume.
4. Tap **OK**.

Related Topic



[Adjusting the Audio Volume](#)

Setting a Ring Tone for a Contact

You can select a unique ring tone for various contacts in your directory. This helps you quickly identify callers according to the ring tones.

By default, the **Auto** is selected, it means that the contact uses the ring tone according to this priority: Group ring tone>Account ring tone>Phone ring tone.

Procedure

1. Tap .
2. Tap the contact group first.
3. Tap  after the desired contact.
4. Select the desired ring tone from the **Ring** field.
The ring tone is played automatically. You can press the Volume key to adjust the ringtone volume.
5. Tap .

Related Topic

[Adjusting the Audio Volume](#)

Setting the Key Tone

You can set the phone to produce a sound when pressing the keypad keys. The key tone is enabled by default.

Procedure

1. Swipe left or right to go to the second idle screen.
2. Navigate to **Settings->Basic Settings->Sound->Key Tone**.
2. Turn on **Key Tone**.
3. Tap .

Enabling Touch Sounds

If you enable touch sounds, the phone will produce a sound when you tap an option on the touch screen.

Procedure

1. Swipe left/right to go to the second idle screen.
2. Navigate to **Settings->Basic Settings->Sound->Touch Sounds**.
3. Turn on **Touch Sounds**.
4. Tap .

Configuring Notification Sound

The phone will produce a notification sound when receiving a notification (e.g., incoming email notification).

Procedure

1. Swipe left or right to go to the second idle screen.
2. Navigate to **Settings->Basic Settings->Sound**.
3. Tap the **Notification Sound** field.
4. Tap the desired notification sound in the pop-up dialog box.
The notification sound is played automatically. You can press the Volume key to adjust the notification sound.

5. Tap **OK**.

Enabling Silent Mode

If you turn on the silent mode, the IP phone won't produce ring tone/key tone/touch sound/notification sound from phone's speaker.

Procedure

1. You can do one of the following:

- Swipe left/right to go to the second idle screen, navigate to **Settings->Basic Settings->Sound**.

Turn on **Silent Mode** and then tap  .

- Press the Volume key to adjust the ringer volume to the minimum.

- Swipe down from the top of the screen to enter the control center and toggle **Silent** on.

Note

You may have no permission to turn on the silent mode. Contact your system administrator for more information.

Directory

The Yealink IP phones provide several types of phone directories, depending on the phone models and what the system administrator has set for you.

The phones provide the following types of directories:

- [Local Directory](#)
- [Blacklist](#)
- [Mobile Contacts](#)
- [Google Contacts](#)
- [Remote Phone Book](#)

Local Directory

You can store up to 1000 contacts and 48 groups in your local directory, allowing you to edit, delete, search or simply dial a contact from the local directory.

Topics

[Managing the Local Directory Groups](#)

[Managing the Local Directory Contacts](#)

[Moving a Local Directory Contact to Blacklist](#)

[Moving a Local Directory Contact to the Shared Directory](#)

[Searching for Contacts](#)

Managing the Local Directory Groups

You can add, edit and delete contacts group in the local directory.

Topics

[Adding Contact Groups](#)

[Editing Contact Groups](#)



[Deleting Contact Groups](#)

Adding Contact Groups

To organize your contacts and make them easier to find, you can add additional groups in the local directory.

When you add a group in the local directory, you can specify a ring tone for this group.



Procedure

1. Tap  -> **Setting**-> **New Group**.
2. Enter the desired group name.
3. Tap .
4. Tap  after the group name to specify a ring tone for the group.
5. Tap the desired ring tone in the pop-up dialog box.
6. Tap **OK**.

Editing Contact Groups

You can change the group name at any time.



Procedure

1. Tap  -> **Setting**.
2. Tap  after the desired group.
3. Edit the group name in the highlighted field.
4. Tap .

Deleting Contact Groups

You can delete a group from the local directory at any time.

Procedure

1. Tap  -> **Setting**.
2. Tap  before the desired group name.
The phone screen prompts you whether to delete the group.
3. Tap **OK**.

Managing the Local Directory Contacts

You can add, edit and delete contacts in the local directory. You can delete a contact or all contacts from the Local Directory.

Topics

[Adding Contacts](#)

[Editing Contacts](#)

[Deleting a Contact](#)



[Deleting All Contacts](#)

Adding Contacts

You can add 100 contacts to your local directory. You can set other information for your contact, including:

- Specify an account to use when calling this contact.
- Specify a ring tone for this contact.
- Specify a contact photo to this contact (only available on the IP phones).

Procedure



1. Tap .
2. If you want to add a contact to the specified contact group, tap the contact group first.
3. Tap .
4. Enter the name and the office, mobile or other numbers in the corresponding fields.
5. Tap the desired account from the **Account** field.
6. Tap the desired ring tone from the **Ring** field.
7. Tap the desired photo from the **Photo** field.
8. Tap .

If the contact already exists in the local directory, the phone will prompt "Contact name existed!".

Editing Contacts



You can change or add more information to your contacts at any time.

Procedure

1. Tap .
2. If you want to edit a contact from the specified contact group, tap the contact group first.
3. Tap  after the desired contact.
4. Tap the desired field to edit the contact information.
5. Tap .



Deleting a Contact

Procedure

1. Tap .
2. If you want to delete a contact from the specified contact group, tap the contact group first.
3. Tap  after the desired contact.
4. Tap **Delete**.
The phone screen prompts you whether to delete the contact.
5. Tap **OK**.

Deleting All Contacts

Procedure



1. Tap .
2. Tap **Setting**.
3. Tap the **Select All** radio box.
4. Tap .

- The phone screen prompts you whether to delete all contacts.
5. Tap **OK**.

Moving a Local Directory Contact to Blacklist

You can move a contact in the local directory to blacklist. Incoming calls from this contact will be rejected automatically.

Procedure

1. Tap .
2. If you want to select a contact to the specified contact group, tap the contact group first.
3. Tap  after the desired contact.
4. Tap **Blacklist**.
The phone screen prompts you whether to move this contact to the blacklist.
5. Tap **OK**.



Moving a Local Directory Contact to the Shared Directory

You can move a contact in the local directory to the shared directory.

Before You Begin

Make sure the Shared Directory is available on your phone.

Procedure

1. Tap .
2. If you want to select a contact to the specified contact group, tap the contact group first.
3. Tap **Setting**.
4. Select a contact.
5. Tap .
6. Tap **New Entry**.
7. Tap .

Related Topic

[Shared Directory](#)

Searching for Contacts

In the Local Directory, you can enter search criteria to find your desired contact quickly.

Procedure

1. Tap .
2. Do one of the following:
 - Tap **Search**.
Enter a few continuous characters of the contact name or continuous numbers of the contact number (office, mobile or other number).
The contacts whose name or phone number matches the entered characters will display in the result list.
 - Tap the desired letter (e.g., T) along the right side to jump to contacts whose names start with T or t.

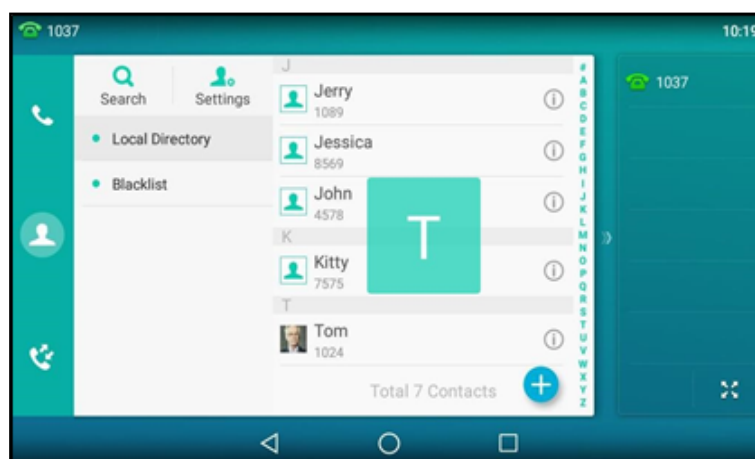

Blacklist

Incoming calls from the blacklist contacts are rejected automatically. You can store 30 contacts in the blacklist to block unwanted callers.

Topics

[Adding a Blacklist Contact](#)



[Editing a Blacklist Contact](#)

[Deleting Blacklist Contacts](#)

[Moving a Blacklist Contact to the Local Directory](#)

Adding a Blacklist Contact



Procedure

1. Tap  > **Blacklist**.
2. Tap .
3. Enter the contact's name and the office, mobile or other numbers in the corresponding fields.
4. Tap the **Account** field and select the desired account in the pop-up dialog box.
5. Tap .

Editing a Blacklist Contact

You can edit your blacklist contacts at any time.

Procedure

1. Tap  > **Blacklist**.
2. Tap  after the desired contact.
3. Tap the desired field to edit the contact information.
4. Tap .

Deleting Blacklist Contacts

You can delete one or all blacklist contacts.



Topics

[Deleting a Blacklist Contact](#)

[Deleting all Blacklist Contacts](#)



Deleting a Blacklist Contact

Procedure

1. Tap  > **Blacklist**.
2. Tap  after the desired contact.
3. Tap **Delete**.
The phone screen prompts you whether to delete the contact.
4. Tap **OK**.

Deleting all Blacklist Contacts



Procedure

1. Tap  -> **Blacklist**.
2. Tap **Setting**.
3. Tap the **Select All** radio box.
4. Tap  .
The phone prompts whether to delete all contacts.
5. Tap **OK**.

Moving a Blacklist Contact to the Local Directory

You can move a blacklist contact to a local directory. Incoming calls from this contact will not be rejected automatically.

Procedure

1. Tap  > **Blacklist**.
2. Tap  after the desired contact.
3. Tap the **Group** field and then select **Local Directory**.
4. Tap  .

Mobile Contacts

You can temporarily synchronize mobile phone contacts. The mobile phone contacts will be imported to your IP phones under Mobile Contacts directory. You can add mobile contacts to the local directory or blacklist, but you cannot add a contact to Mobile Contacts directory on your IP phones.

Note

If you disconnect the Bluetooth-enabled mobile phone from IP phone or disable the IP phone to synchronize phone contacts, the mobile contacts will not display.

Topics

[Adding a Mobile Contact to the Local Directory/Blacklist](#)

[Searching for Mobile Contacts](#)

[Updating the Mobile Contacts](#)



Adding a Mobile Contact to the Local Directory/Blacklist

You can add mobile contacts to the Local Directory or Blacklist. The mobile contacts added to the Local Directory or Blacklist will not disappear, even after you disconnect the mobile phone from the IP phone.

Before You Begin

Make sure your Bluetooth-enabled mobile phone has been paired with and connected to your IP phones, and mobile contact sync feature is enabled.

Procedure

1. Tap  -> **Mobile Contacts**.
 2. Tap  after the desired contact.
 3. Tap the **Group** field and select **Local Directory** or **Blacklist**.
 4. Tap .
- The contact is successfully saved to the Local Directory or Blacklist.

Related Topics

[Pairing and Connecting the Bluetooth-Enabled Mobile Phone](#)

[Syncing the Mobile Contacts to the IP Phone](#)

[Configuring the Phone Audio Feature](#)

Searching for Mobile Contacts

In the Mobile Contacts, you can enter search criteria to find your desired mobile contact quickly.

Before You Begin

Make sure your Bluetooth-enabled mobile phone has been paired with and connected to your IP phones, and mobile contact sync feature is enabled.

Procedure

1. Tap  -> **Mobile Contacts**.
2. Do one of the following:
 - Tap **Search**.
Enter a few continuous characters of the contact name or continuous numbers of the contact number (office, mobile or other number).
The contacts whose name or phone number matches the entered characters will display in the result list.
 - Tap the desired letter (e.g., T) along the right side to jump to contacts whose names start with T or t.

Related Topics

[Pairing and Connecting the Bluetooth-Enabled Mobile Phone](#)

[Syncing the Mobile Contacts to the IP Phone](#)



Updating the Mobile Contacts

You can update the Mobile Contact to synchronize the contacts you add, edit, delete on the mobile phone to your IP phone.

Before You Begin

Make sure your Bluetooth-enabled mobile phone has been paired with and connected to your IP phones, and mobile contact sync feature is enabled. Note that the IP phone should be authorized to temporarily synchronize the contacts stored in your mobile phone.

Procedure

1. Tap  -> **Mobile Contacts**.
 2. Tap .
- The phone screen prompts "Updating, please wait..."

Note

If you disconnect the mobile phone from the IP phone when the IP phone is updating the Mobile Contacts, the phone screen will prompt "Fail to download mobile contacts!", and the mobile contacts disappear from the IP phone directory list.

Related Topics

[Pairing and Connecting the Bluetooth-Enabled Mobile Phone](#)

[Syncing the Mobile Contacts to the IP Phone](#)

[Configuring the Phone Audio Feature](#)

Google Contacts

You can enable the Google Contacts feature to get contacts from your Google account. The contacts are imported to your phone under Google Contacts directory. You can view, add, edit, delete, or search a Google contact.

Topics

[Enabling the Google Contacts Feature](#)

[Viewing Google Contacts](#)

[Adding a Google Contact](#)

[Editing a Google Contact](#)

[Deleting a Google Contact](#)

[Searching for Google Contacts](#)

[Manually Updating the Google Contacts](#)

Enabling the Google Contacts Feature

Before You Begin

Make sure you have added a Google account to your phone.

Procedure

1. Swipe left or right to go to the second idle screen.
2. Navigate to **Settings**->**Basic Settings**->**Google Contacts**.
3. Mark the **On** radio box.

Related Topic



[Adding APP Accounts](#)

Viewing Google Contacts

Before You Begin

Make sure the Google Contacts feature is enabled.

Procedure

1. Navigate to  ->**Google Contacts**.
2. Drag up and down to scroll through the Google contacts list.
3. Tap  beside the desired contact.
The detailed information of the entry appears on the phone screen.

Related Topic



[Enabling the Google Contacts Feature](#)

Adding a Google Contact

Before You Begin

Make sure the Google Contacts feature is enabled.

Procedure

1. Navigate to  -> **Google Contacts**.
2. Tap .
3. Enter the contact's name, number, email, address, company, and some other personal information.
4. Tap .

Note



When you first add a Google contact, a message is displayed to confirm that your new contact will be synchronized with your Google account.

Related Topic

[Enabling the Google Contacts Feature](#)



Editing a Google Contact

Procedure

1. Navigate to  -> **Google Contacts**.
2. Tap  beside the desired contact.
3. Tap the desired field to edit the contact information.
4. Tap .

Deleting a Google Contact

Procedure

1. Navigate to  -> **Google Contacts**.
2. Tap  beside the desired contact.
3. Tap **Delete**.
The phone screen prompts you whether to delete the contact.
4. Tap **OK**.

Searching for Google Contacts

In the Google Contacts, you can enter search criteria to find your desired Google contact quickly.

Procedure

1. Navigate to  -> **Google Contacts**.
2. Tap **Search**.
3. Enter a few continuous characters of the contact name or continuous numbers of the contact number (office, mobile or other number).
The contacts whose name or phone number matches the entered characters will display in the result list.

Manually Updating the Google Contacts

You can manually update the Google Contacts list.

Note

Network may affect the contacts synchronization. You can try to sync contacts from Google via syncing APP accounts information.

Procedure

1. Navigate to  -> **Google Contacts**.
2. Tap .

Related Topic

[Syncing APP Account Information](#)

Remote Phone Book

If the Remote Phone Book feature has been enabled by your system administrator, you can access your corporate directory directly from your phone. You can simply dial a contact from the corporate directory. You can also search for a contact or add contacts from the remote phone book to the local directory.

You can only access up to 5 remote phone books on your phone. Check with your system administrator to find out if this feature is available.

Topics

[Searching for Remote Phone Book Contacts](#)

[Adding a Remote Phone Book Contact to the Local Directory or Blacklist](#)

Searching for Remote Phone Book Contacts

In the Remote Phone Book, you can enter search criteria to find your desired contact quickly.



Procedure

1. Tap  > **Remote Phone Book**.
2. Do one of the following:
 - Tap **Search**.
Enter the name or number you are looking for in the search field.
The contacts whose name or phone number matches the entered characters will display in the result list.
 - Tap the desired letter (e.g., T) along the right side to jump to contacts whose names start with T or t.

Adding a Remote Phone Book Contact to the Local Directory or Blacklist

You can add contacts in the remote phone book to the local directory or blacklist. The contact you add from the remote phone book will not disappear from your local directory, even if your system administrator deletes this contact from the remote phone book.

Procedure

1. Tap  > **Remote Phone Book**.
2. Tap the desired remote phone book.
3. Tap  after the desired contact in the remote phone book.
4. Tap **Add**.
5. Tap the **Group** field and then select **Local Directory** or **Blacklist**.
6. Tap .

Call History

The IP phones maintain call history lists of Missed Calls, Placed Calls, Received Calls and Forwarded Calls.

Topics

[Viewing History Records](#)

[Adding a History Record to Local Directory or Blacklist](#)

[Adding a History Record to Shared Directory](#)



[Deleting History Records](#)

[Disabling History Record](#)

Viewing History Records

You can view a list of up to 100 Missed Calls, Placed Calls, Received Calls and Forwarded Calls.



Procedure

1. Tap  .
The phone screen displays all call records.
2. Select the desired list.
3. Tap  after the desired entry.
The detailed information of the entry appears on the phone screen.

Adding a History Record to Local Directory or Blacklist

You can add a history record to the local directory or to the blacklist.

Procedure

1. Tap  .
The phone screen displays all call records.
2. Select the desired list.
3. Tap  after the desired entry.
4. Tap **Add** or **Blacklist**.
5. Edit the corresponding fields.
6. Tap  .



Adding a History Record to Shared Directory

You can add a history record to the Shared Directory.

Before You Begin

Make sure the Shared Directory is available on your phone.

Procedure

1. Tap  .
The phone screen displays all call records.
2. Select the desired list.
3. Tap  after the desired entry.
4. Tap **Add**.
5. Tap **Shared Directory** from the **Group** field
6. Edit the corresponding fields.
7. Tap  .

Related Topic

[Shared Directory](#)

Deleting History Records

You can delete one or all call records from the call history list.



Topics

[Deleting a Call Record](#)

[Deleting All Call Records](#)



Deleting a Call Record

Procedure

1. Tap  .
The phone displays all call records.
2. Select the desired list.
3. Tap  after the desired entry, and then tap **Delete**
The phone prompts whether to delete the record.
5. Tap **OK**.

Deleting All Call Records

Procedure

1. Tap  .
2. Select the desired list.
3. Tap **Settings**.
4. Tap the **Select All** radio box.
5. Tap  .
The phone prompts whether to delete all the records.
5. Tap **OK**.

Disabling History Record

History record feature is enabled by default, if you do not want to save the call log, you can disable this feature.

Procedure

1. Swipe left or right to go to the second idle screen.
2. Navigate to **Settings->Features->History Record**.
3. Turn off **History Record**.
4. Tap  .

Call Features

You can place a call, answer a call, transfer a call, etc. on Yealink IP phone.

Topics

[Switching Among the Handset, Speakerphone and Headset Modes](#)

[Changing the Default Account](#)

[Placing Calls](#)

[Answering Calls](#)

[Audio-only/Video Call Selection](#)

[Switching Between Calls Screen and Idle Screen](#)

[Options During a Video Call](#)

[Capturing a Screenshot](#)

[Silencing or Rejecting Incoming Calls](#)

[Ending Calls](#)

[Auto Redial](#)

[Call Mute](#)

[Call Hold](#)

[Do Not Disturb \(DND\)](#)

[Redirecting Incoming Calls](#)

[Transferring Calls](#)

[Conference Calls](#)

[Call Recording](#)

[Multicast Paging](#)

Switching Among the Handset, Speakerphone and Headset Modes

You can select the desired mode before placing a call, or can alternate among Speakerphone, headset, and handset modes during a call.

You can switch the audio output mode of a phone.

- **Switching to handset mode**

Pick up the handset to switch to the handset mode.

- **Switching to speakerphone (hands-free) mode**

Press the Speakerphone key to switch to the speakerphone (hands-free) mode. The LED indicator glows green when the speakerphone is activated.

- **Switching to headset mode**

Press the HEADSET key to switch to the headset mode. The LED indicator glows green when the headset is activated.

Note

Your system administrator can disable you to use the handset, speakerphone (Hands-free) or headset mode.

Related Topic

[Headset](#)

Changing the Default Account

If there are multiple accounts registered on the phone, the phone will use the default account to dial out by default.

From the idle screen, you can press the left or right navigation key to select the desired account as the default account for all IP phones.

You can also tap the label of the default account at the top left, and then tap the desired account to be the new default account.

Procedure

1. Swipe left or right to go to the second idle screen.
2. Navigate to **Settings**->**Features**->**Default Account**.
2. Select the desired account from the **Default Account** field.
3. Tap  .

Related Topic

[Placing Calls](#)

Placing Calls

You can use your phone like a regular phone to place calls in many ways easily.

By default, the phone uses the default account to place a call.

Topics

- [Placing a Call from the Dialer](#)
- [Placing Multiple Calls](#)
- [Placing a Call with a Speed Dial Key](#)
- [Placing a Call Back to the Last Incoming Number](#)
- [Redialing a Number](#)
- [Dialing a Hotline Number](#)
- [Placing an International Call](#)
- [Placing a Call from the Call History](#)
- [Placing a Call from the Directory](#)
- [Placing an Anonymous Call](#)
- [Placing a Call from the Google Contacts](#)

Placing a Call from the Dialer

The Dialer enables you to enter a number to place a call and display a list of previously placed calls or similar numbers in your directory. You can also select the desired contact from the search list, or select a contact from the placed call list or Directory before you enter the number.

Use your phone just like any other phone to make a call.

Note

Your system administrator can configure the source list for searching and disable to display the placed call records. Check with your system administrator to find out if they are available on your phone.

Procedure

1. Do one of the following:
 - Type a phone number.
 - Tap the desired line key.
 - Pick up the handset, press the Speakerphone key or the HEADSET key.
2. Enter a number.

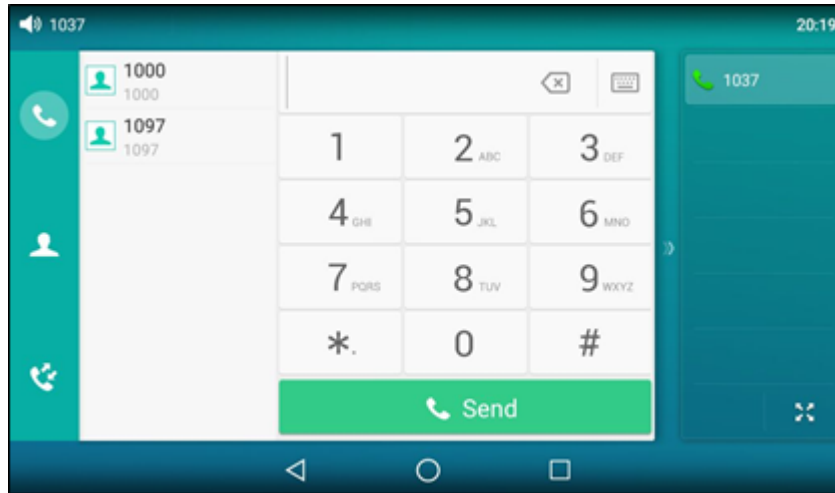

3. Tap **Send**.

You can directly select a contact to call out.

Note

Your system administrator can enable live dialpad feature, which enables your phone to automatically dial out the phone number after a period of time without tapping the **Send** soft key. Check with your system administrator to find out if this feature is available on your phone.

Related Topic

[Switching Among the Handset, Speakerphone and Headset Modes](#)

Placing Multiple Calls

When you are in a call, you can hold your current call and place a new call.

Procedure

1. Do one of the following:
 - Tap the line key. The active call is placed on hold.
 - Press the HOLD key or tap **Hold** to place the original call on hold.
Tap **New Call**.
2. Enter the desired number or select a contact.
3. Tap **Send**.

Related Topic

[Call Hold](#)

Placing a Call with a Speed Dial Key

You can quickly dial a number which is used frequently or hard to remember by using a speed dial key.

Topics

[Setting a Speed Dial Key Manually](#)

[Speed Dialing a Contact Using a Speed Dial Key](#)

Setting a Speed Dial Key Manually

You can set a line key as a Speed Dial key for a contact number.

Procedure

1. Swipe left or right to go to the second idle screen.
2. Navigate to **Settings->Features->Dsskey**.
3. Select the desired line key.
4. Select **Speed Dial** from the **Type** field.
5. Select the desired line from the **Account ID** field.
6. (Optional.) Enter the string that will appear on the touch screen in the **Label** field.
7. Enter the contact number that you want to dial out directly in the **Value** field.
8. Enter the key sequence that you want to send via DTMF in the **Extension** field.
9. Tap  .

Tip

You can drag the line key to the **Edit** field to set it as a Speed Dial key.

Speed Dialing a Contact Using a Speed Dial Key

Before You Begin

You need to set a line key as a Speed Dial key.

Procedure

1. Tap a Speed Dial key when the phone is idle.

Related Topic

[Setting a Speed Dial Key Manually](#)

Placing a Call Back to the Last Incoming Number

You can place a call back to the last incoming number quickly by using a Recall key.

Topics

[Setting a Recall Key](#)

[Recalling a Contact](#)

Setting a Recall Key

You can set a line key as a Recall key.

Procedure

1. Swipe left or right to go to the second idle screen.
2. Navigate to **Settings->Features->Dsskey**.

3. Select the desired line key.
4. Select **Key Event** from the **Type** field.
5. Select **ReCall** from the **Key Type** field.
6. (Optional.) Enter the string that will appear on the phone screen in the **Label** field.
7. Tap .

Tip

You can drag the line key to the **Edit** field to set a Recall key.

Recalling a Contact

Before You Begin

You need to set a line key as Recall key.

Procedure

1. Tap the Recall key.

Related Topic

[Setting a Recall Key](#)

Redialing a Number

The phone keeps a record of all the placed calls. You can call the recently dialed phone number.

Procedure

1. Press the REDIAL key.
The phone screen displays the placed calls list.
2. Tap the desired record.

Tip

Press the REDIAL key twice to call the last dialed number.

Dialing a Hotline Number

You can configure a hotline number and hotline delay. Then the IP phone will dial out the hotline number automatically after the delay time when you lift the handset, press the Speakerphone key or the line key.

Topic

[Setting a Hotline Number and Delay Time](#)

Setting a Hotline Number and Delay Time

Procedure

1. Swipe left or right to go to the second idle screen.
2. Navigate to **Settings->Features->Hot Line**.
3. Enter the desired number in the **Number** field.
4. Enter the desired delay time between 0 and 10 (seconds) in the **HotLine Delay** field.

5. Tap  .

Placing an International Call

You can place an international call when you prefix the phone number with a plus sign (+).

Procedure

1. Long tap digit key 0 on the phone keypad until the **plus sign (+)** appears.
2. Enter the phone number.
3. Tap **Send**.

Placing a Call from the Call History

You can place calls to the contact from the Call History list. The Call History list contains missed calls, placed calls, received calls, and forwarded calls.

Procedure

1. Tap  .
The phone screen displays all call records.
2. Select the desired call list.
3. Tap the desired entry.

Placing a Call from the Directory

You can call contacts from your phone directories.

Procedure

1. Tap  .
2. Select the desired directory.
3. If the contact was added to a specified contact group, you can select the desired contact group.
4. Tap the desired contact.
If the selected contact has multiple numbers, tap the desired number to dial out.

Related Topic

[Searching for Contacts](#)

Placing an Anonymous Call

You can place a call to someone without revealing your identification by blocking your name or phone number from being displayed to the recipient.

Note

Anonymous call is not available on all servers. Check with your system administrator to find out if this feature is available on your phone.

You need to enable anonymous call for a specific line first, and then place calls in this line.

Topics

[Enabling Anonymous Call](#)
[Placing an Anonymous Call](#)

Enabling Anonymous Call

Before You Begin

Check with your system administrator if the anonymous call on code or off code is required. If required, get it from your system administrator.

Procedure

1. Swipe left or right to go to the second idle screen.
2. Navigate to **Settings->Features->Anonymous**.
3. Select the desired line.
4. Turn on **Local Anonymous**.
5. (Optional.) Tap the **On Code** or **Off Code** radio box in the **Send Anony Code** field.
6. (Optional.) Enter the anonymous call on code and off code respectively in the **On Code** and **Off Code** field beneath the **Send Anony Code** field.
7. Tap  .

Placing an Anonymous Call

Before You Begin

Enable anonymous call for a specific line.

Procedure

1. Select the anonymous line to place a call.
The callee is prompted with an incoming call from anonymity.

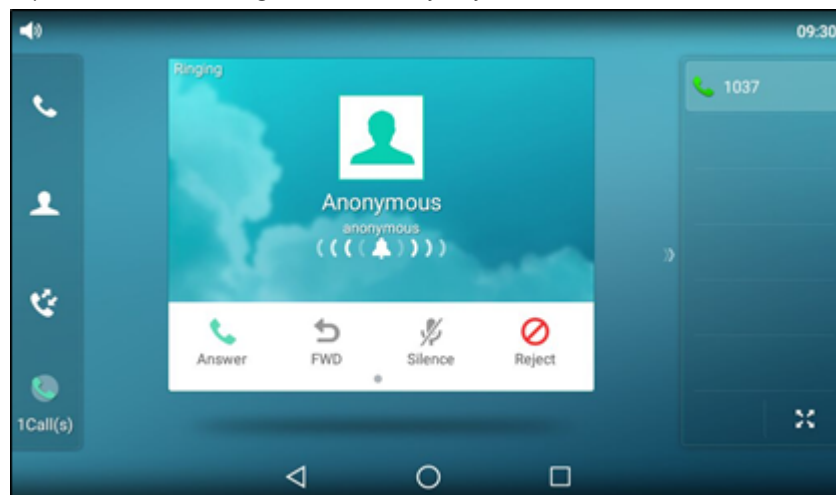

If the callee enables anonymous rejection feature, you may be prompted that the callee does not accept calls from an anonymous number.

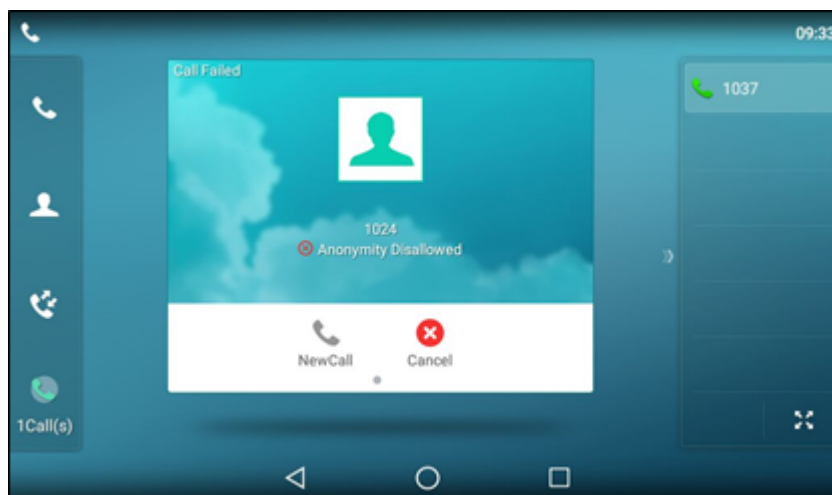

Related Topics

[Enabling Anonymous Call](#)

[Rejecting Anonymous Calls Automatically](#)

Placing a Call from the Google Contacts

You can place calls to the contact from the Google Contacts list.

Before You Begin

Make sure the Google Contacts feature is enabled.

Procedure

1. Navigate to  -> **Google Contacts**.
2. Tap the desired contact.
If the selected contact has multiple numbers, tap the desired number.

Related Topics

[Enabling the Google Contacts Feature](#)

[Searching for Google Contacts](#)

Answering Calls

When you receive a call, you can choose to manually answer it or answer it automatically.

Topics

[Answering a Call](#)

[Answering a Call When in a Call](#)

[Answering a Call Automatically](#)

Answering a Call

Procedure

1. Do one of the following:

- Pick up the handset.
- Press the Speakerphone key.
- Press the HEADSET key. The key LED glows green.
- Tap **Answer** or the line key.
The call is answered in the speakerphone (hands-free) mode by default.

Related Topic

[Switching Among the Handset, Speakerphone and Headset Modes](#)

Answering a Call When in a Call

When you are in an active call and an incoming call arrives on the phone, the call waiting tone beeps, and the incoming call information is displayed.

Before You Begin

Enable call waiting feature on the phone.

Procedure

1. Tap **Answer**.
The active call is placed on hold, and the incoming call becomes active.

Related Topic

[Enabling Call Waiting](#)

Enabling Call Waiting

Call waiting enables you to receive another call when there is already an active call on your phone. If it is disabled, the new incoming call will be rejected automatically.

You can enable call waiting feature to avoid missing important calls during a call. You can also set the phone to play a warning tone when the new incoming call arrives.

Before You Begin

Check with your system administrator if the call waiting on code or off code is required. If required, get it from your system administrator.

Procedure

1. Swipe left or right to go to the second idle screen.
2. Navigate to **Settings**->**Features**->**Call Waiting**.
3. Tap the **On** radio box in the **Call Waiting** field.
3. Tap the **On** radio box in the **Play Tone** field.
4. (Optional.) Enter the call waiting on code or off code respectively in the **On Code** or **Off Code** field.
5. Tap  .

Answering a Call Automatically

Auto answer enables you to automatically answer an incoming call in speakerphone (hands-free) mode when your phone is idle.

Procedure

1. Swipe left or right to go to the second idle screen.
2. Navigate to **Settings**->**Features**->**Auto Answer**.
3. Select the desired line.
4. Tap the **On** radio box in the desired line.
5. Tap  .

If the auto answer feature is enabled for the default account, the auto answer icon appears on the phone screen.

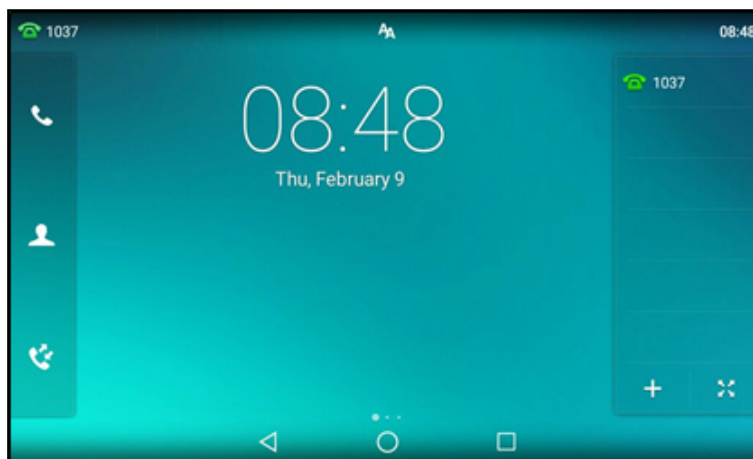

Tip

You can also swipe down from the top of the screen to enter the control center, tap **Auto Answer** to enter **Auto Answer** setting screen, and then enable auto answer feature for the desired line.

Audio-only/Video Call Selection

You can choose to establish an audio-only call or video call while dialing or ringing; or switch between an audio-only call or video call. This feature should be pre-configured by your system administrator.

Topics

[Placing an Audio-only/Video Call](#)

[Answering a Video Call](#)

[Switching between Video Call and Audio-only Call](#)

Placing an Audio-only/Video Call

Procedure

1. Do one of the following:
 - Enter the desired number when the phone is idle.
 - Tap the line key when the phone is idle to enter the dialing screen.
Enter the desired number.

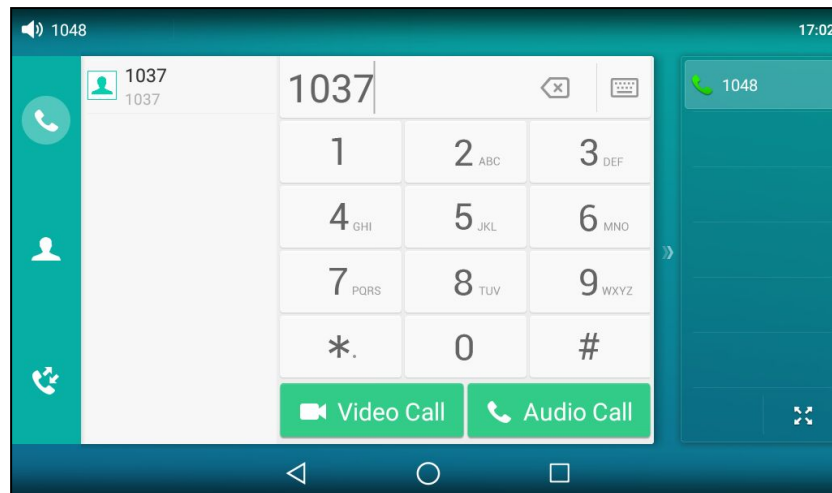

2. Tap **Video Call/Audio Call** to place a video call or audio-only call.

Answering a Video Call

When an incoming video call arrives, you can choose to answer the call with audio-only/video.

Procedure

When an incoming call arrives, the touch screen will display as below:

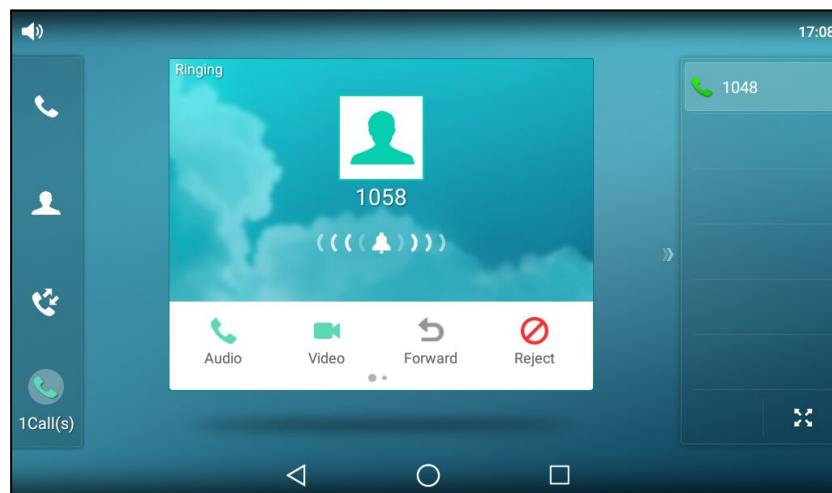

1. Tap **Audio/Video** to establish an audio-only call or video call.

Switching between Video Call and Audio-only Call

Your system administrator can make you have the option to switch between a video call and audio-only call during the active call.

Note

You cannot switch between a video call and audio-only call during a three-way conference, or while the call is placed on hold.

Topics

[Switching to the Audio-only Call](#)

[Initiating a Video Call](#)

[Accepting or Ignoring a Video Call Request](#)

Switching to the Audio-only Call

During the video call, you can switch to the audio-only call quickly.

Procedure

1. During an active video call, tap  if required.
2. Tap **Audio Only**.
The audio-only call is automatically established.

Related Topic

[Initiating a Video Call](#)

Initiating a Video Call

During the audio-only call, you can initiate a video call.

Procedure

1. During an audio-only call, swap the soft key area left and then tap **Add Video**.
By default, the video call is automatically established with the other party that is video-enabled.
If the other party can only establish an audio-only call, the screen prompts "The other end is not available".
If the other party accepts the video call request, the video call is established; if the other party ignores the request, the screen prompts "The other end is not available"; if there is no response within 20 seconds, the call is still audio-only.

Related Topics

[Accepting or Ignoring a Video Call Request](#)

[Switching to the Audio-only Call](#)

Accepting or Ignoring a Video Call Request

While the other party initiates a video call during the audio-only call, you can choose to accept or ignore the request.

Procedure

1. When another party initiates a video call, tap **Accept** or **Ignore**.

Related Topic

[Initiating a Video Call](#)

Switching Between Calls Screen and Idle Screen

During the call, you may want to see if there is an event on schedule or check if there is a new email in the inbox and so on, you can exit the talking screen to access the corresponding application. And after the operation, you can return to the call conveniently.

Topics

[Going to the Idle Screen during a Call](#)

[Returning to the Talking Screen](#)

Going to the Idle Screen during a Call

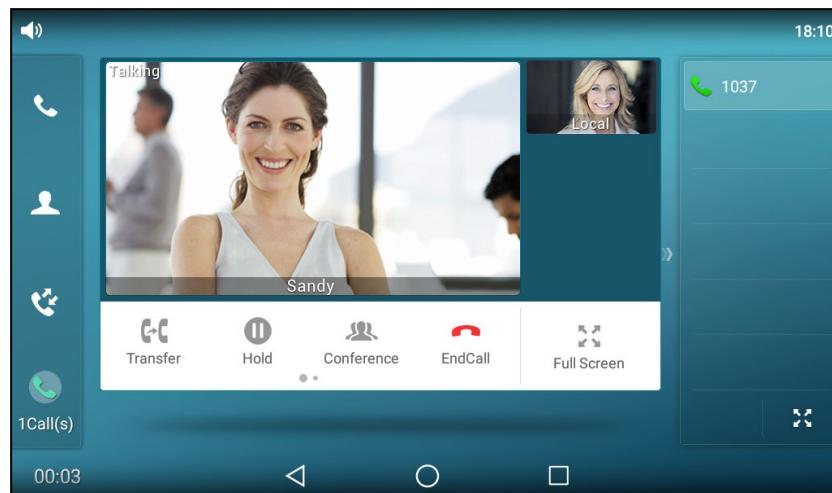

Procedure

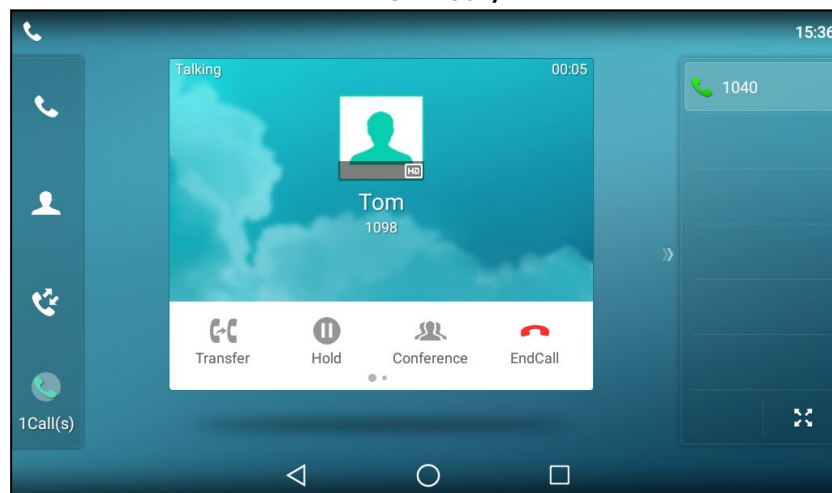

SIP-T58V/A



SIP-T56A

1. Tap ,  or  to go to the idle screen.

Returning to the Talking Screen

Procedure

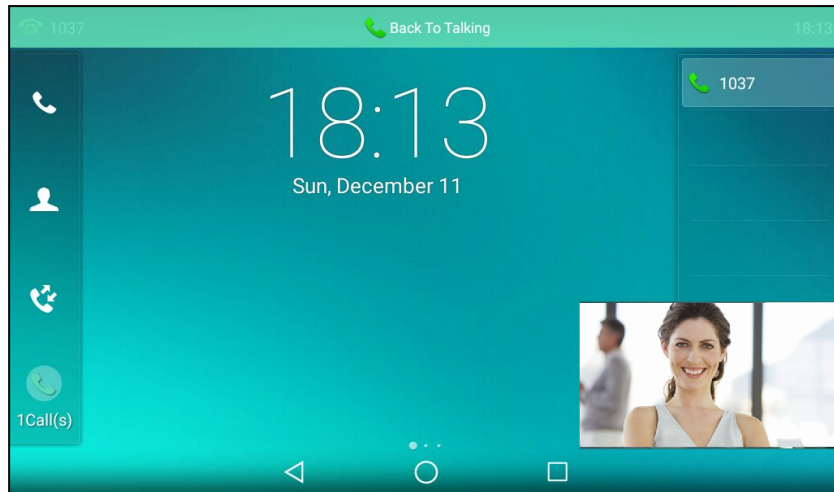

SIP-T58V/A

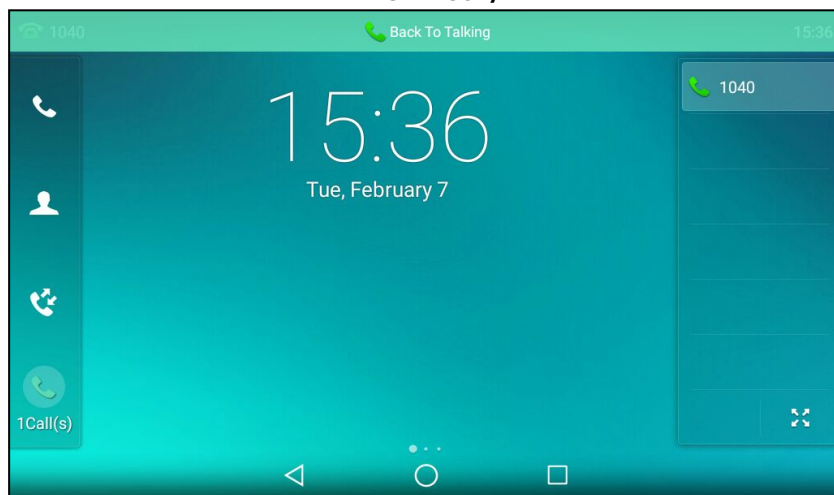

SIP-T56A

Do one of the following when you are in the idle screen:

- Tap .
- Tap **Back To Talking** on the top of the touch screen.
- For SIP-T58V/A, tap the floating video window.

Options During a Video Call

You can do the following during a video call on T58V/T58A/T56A:

- Stop Transmitting Video during a Call (only for T58V/A)
- Change the Video Layout during Calls
- Preview the Near-Site Video (only for T58V/A)

Topics

[Stopping Transmitting Video during a Call](#)

[Changing the Video Layout during Calls](#)

[Previewing the Near-Site Video \(Only for T58A\)](#)

Stopping Transmitting Video during a Call

You can unplug the camera or swipe down from the top of the screen in the video call screen and then tap **Video** to stop your phone from automatically transmitting your video during a video call. However, you cannot turn off far-site video.

If you stop transmitting video, the icon  will display on the near-site video, as shown below:

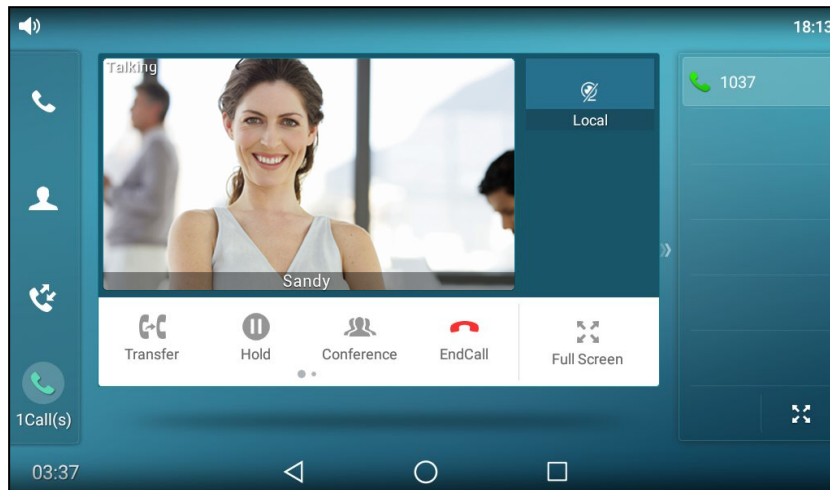

Your camera will not transmit video to your contact and the far site cannot see you.

Stopping transmitting video does not create an audio-only call. Even if you stop transmitting video, you can see the other party, and the call is still a video call. To place an audio-only call, contact your system administrator.

Changing the Video Layout during Calls

During video calls, near-site and far-site video images are displayed on the touch screen. You can change the video layout.

The system supports three video layouts:

- One large, other small: One video image displays in a large size, the other video images along the right side of the screen displays in small sizes.
- Full screen: One video image displays in full size, the other video images are hidden.
- Same size: All video images display in the same size.

Topics

[Swapping Video During a Video Call](#)

[Changing the Video Layout to the Same Size Mode During a Video Call](#)

[Changing the Video Layout to the Full Screen Mode During a Video Call](#)

[Changing the Video Layout During a Video Conference Call](#)

Swapping Video During a Video Call

Procedure

1. Tap the near-site (small window) video during a video call.

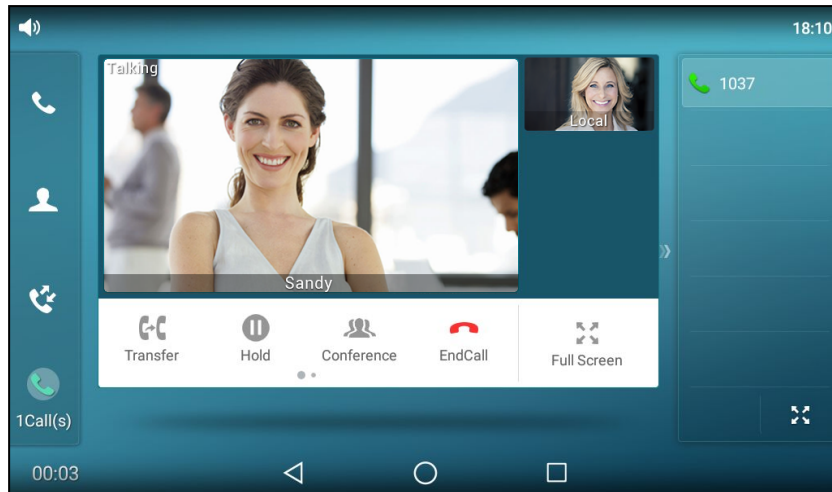

The near-site video will display in the center of the touch screen, and the far-site video will display on the top-right of the touch screen.

The following figure shows what the touch screen looks like after you tap the near-site video:

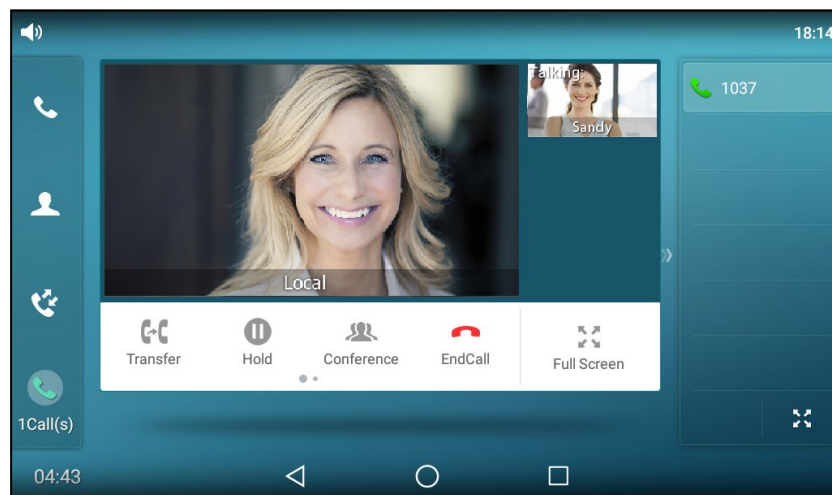

Changing the Video Layout to the Same Size Mode During a Video Call

Procedure

1. From the video call full-screen, pinch close the large window.

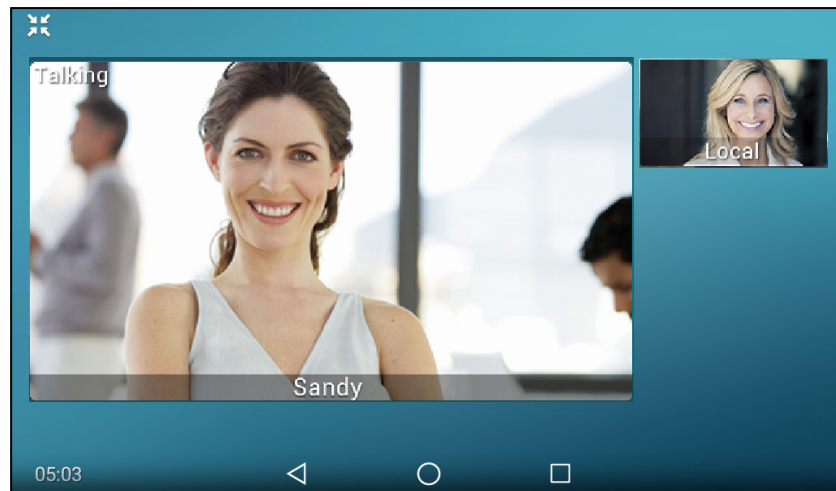

The following figure shows what the touch screen looks like in the same size mode:

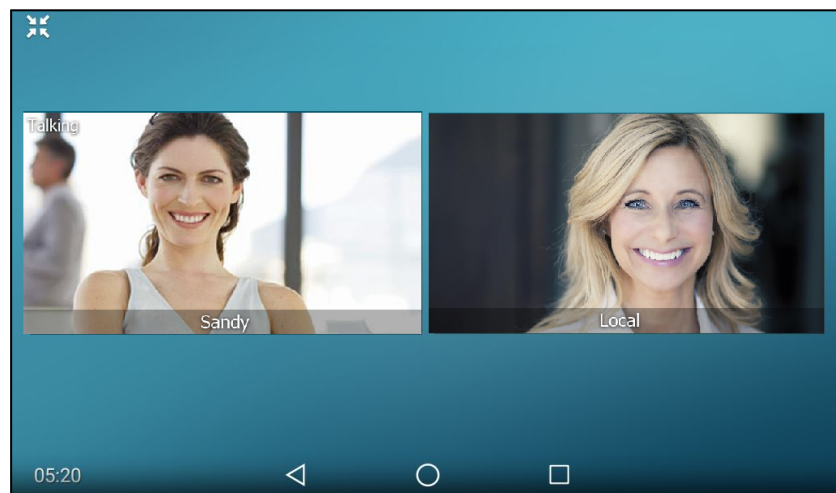

Changing the Video Layout to the Full Screen Mode During a Video Call

Procedure

1. From the video call full-screen, do one of the following:

- Tap the large window.
- Pinch open the large window.

The small window is hidden, and the following figure shows what the touch screen looks like in full screen mode:

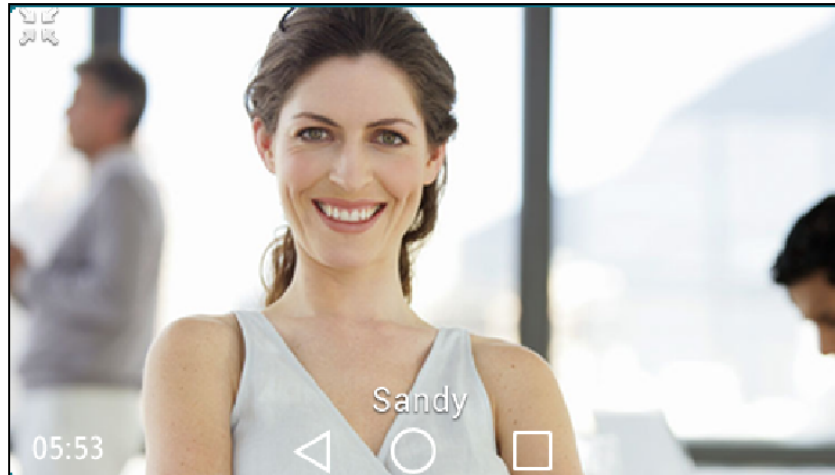



Changing the Video Layout During a Video Conference Call

Procedure

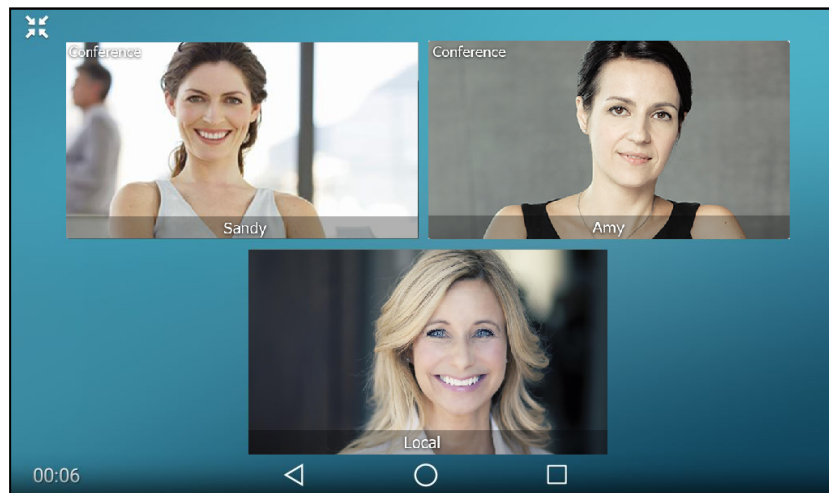
The default screen layout during a video conference call is the same size mode. The following figure shows what the touch screen looks like during a three-way video conference call:



You can tap  /  or the blank area of the touch screen to go back to video call screen or tap one of the conference party to go back to the "one big, other small" layout.

The following figure shows what the touch screen looks like in the "one big, other small" layout during a three-way video conference call:

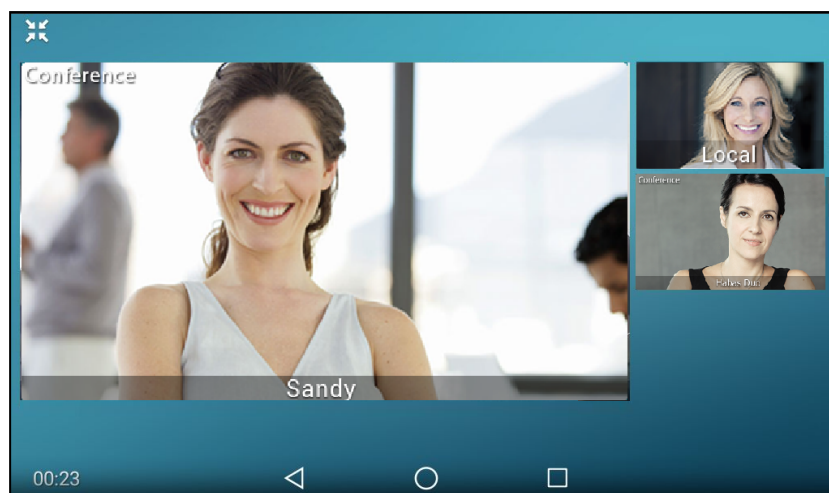

Previewing the Near-Site Video (Only for T58A)

If you have connected the camera to the phone, you can preview the video of yourself that you display during video calls. During previewing, you can also configure camera settings.

Procedure

- Swipe down from the top of the screen to enter the control center and tap **Video**.
- Swipe left or right to go to the second idle screen and tap  to launch **Camera** application.

Related Topic

[Camera Settings](#)

Capturing a Screenshot

You can capture a screenshot when the phone is idle or during the call. The screenshots are saved in *.png format in the internal SD card with the name consisting of a prefix "Screenshot" and date & time stamp. You can view the screenshots by [File Manager](#) or [Gallery](#) application.

Tip

You can view the screenshots on either the phone itself or on a computer using an application capable of viewing *.png files.

Topics

[Capturing a Screenshot on the Control Center](#)

[Capturing a Screenshot During a Call](#)

Capturing a Screenshot on the Control Center

Procedure

1. Swipe down from the top of the screen to enter the control center.
2. Tap **Screenshot**.

If the screenshot is successfully saved, the notification center will display a notification "Screenshot captured."

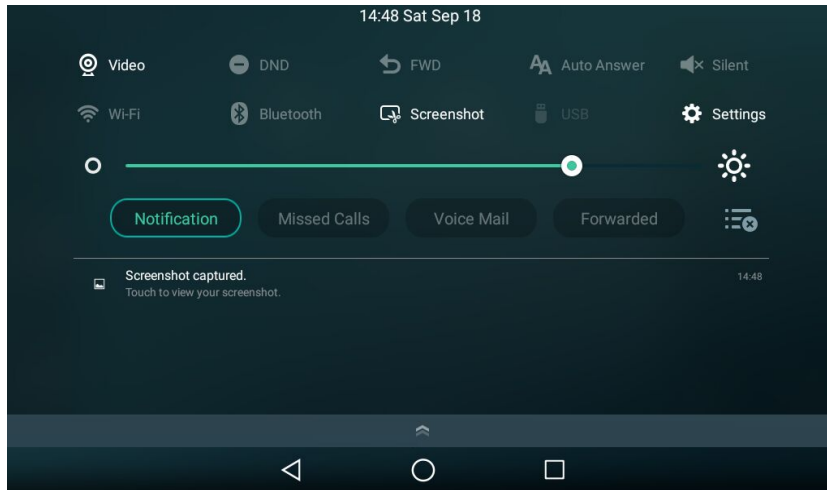

SIP-T58V/A

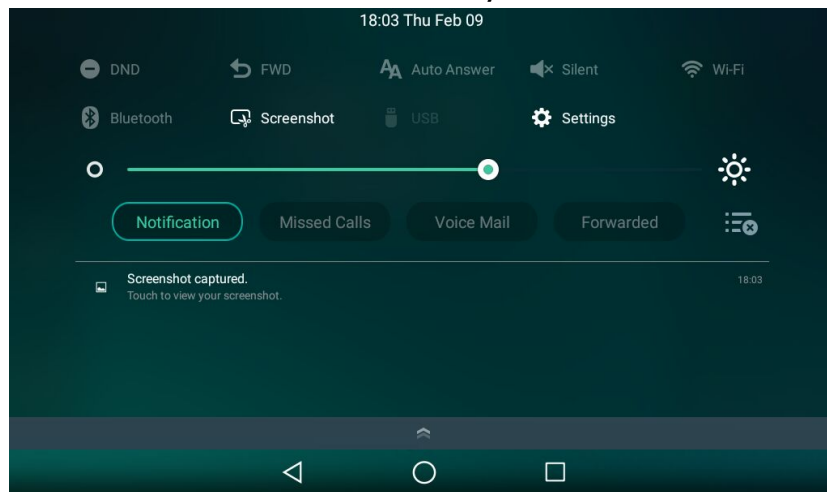

SIP-T56A

You can tap the notification to view the latest screenshot.

If there is not enough space in internal SD card, you cannot save the screenshot, and the notification center will display a notification "Couldn't capture screenshot."

Capturing a Screenshot During a Call

Procedure

1. Press the MESSAGE Key.

If the screenshot is successfully saved, the notification center will display a notification "Screenshot captured."

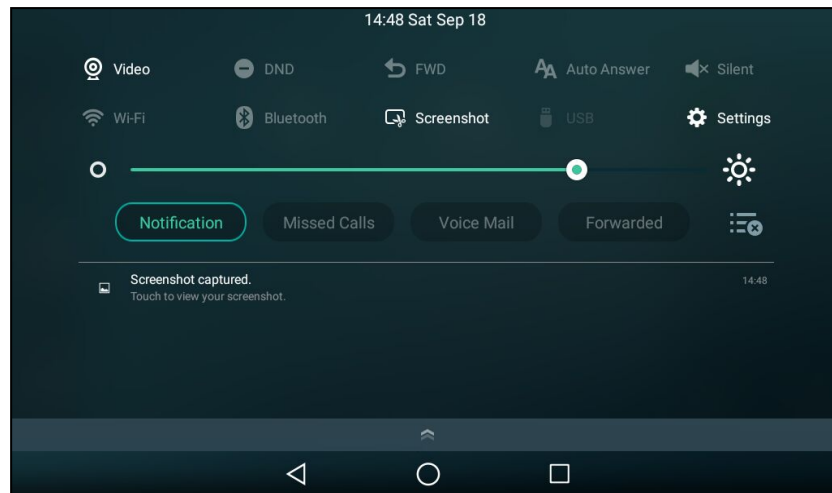

SIP-T58V/A

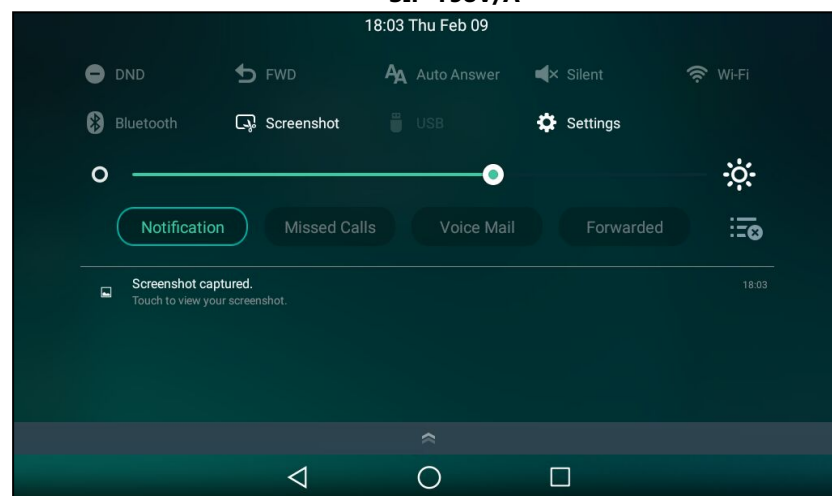

SIP-T56A

You can tap the notification to view the latest screenshot.

If there is not enough space in internal SD card, you cannot save the screenshot, and the notification center will display a notification "Couldn't capture screenshot."

Silencing or Rejecting Incoming Calls

When you receive an incoming call, you can choose to silence or reject the call instead of answering.

Topics

[Silencing a Call](#)

[Rejecting a Call Manually](#)

[Rejecting Anonymous Calls Automatically](#)

Silencing a Call

You can silence a call to stop your phone from ringing. Even if you silence the call, the incoming call notification continues to display on your phone.

Procedure

1. Tap **Silence**.

Rejecting a Call Manually

Procedure

1. Tap **Reject** to reject an incoming call.

Rejecting Anonymous Calls Automatically

You can set your phone to automatically reject incoming calls from callers who have withheld their caller ID information (including the name or phone number). As a result, your phone will not ring and you will not be notified of an attempted call.

Before You Begin

Check with your system administrator if the anonymous call rejection on code or off code is required. If required, get it from your system administrator.

Procedure

1. Swipe left or right to go to the second idle screen.
2. Navigate to **Settings**->**Features**->**Anonymous**.
2. Select the desired line.
3. Turn on **Anonymous Rejection**.
4. (Optional.) Tap the **On Code** or **Off Code** radio box in the **Send Rejection Code** field.
5. Enter the anonymous call rejection on code and off code respectively in the **On Code** and **Off Code** field beneath the **Send Rejection Code** field.
6. Tap  .

When the caller has anonymous call feature enabled and places a call to your IP phones, the call is automatically rejected.

Related Topic

[Placing an Anonymous Call](#)

Ending Calls

Procedure

1. Do one of the following:
 - If you are using the handset, tap **End Call** or hang up the handset.
 - If you are using the headset, tap **End Call**.
 - If you are using the speakerphone, press the Speakerphone key or tap **End Call**.

Auto Redial

Auto Redial enables you to redial a phone number automatically when the callee is busy.

Topics

[Setting the Auto Redial](#)

Redialing a Call Automatically

Setting the Auto Redial

You can enable auto redial, set the number of auto redial attempts and the time to wait between redial attempts.

Procedure

1. Swipe left or right to go to the second idle screen.
2. Navigate to **Settings->Features->Auto Redial**.
3. Turn on **Auto Redial**.
4. Enter the desired time (between 1 and 300 seconds) in the **Redial Interval** field.
5. Enter the desired times (between 1 and 300) in the **Redial Times** field.
6. Tap ✓ .

Redialing a Call Automatically

Before You Begin

Enable auto redial feature on the phone.

Procedure

1. When the callee is busy, the phone screen prompts whether to auto redial the contact, tap **OK** to activate auto redial.

The phone screen displays the redial times and interval.

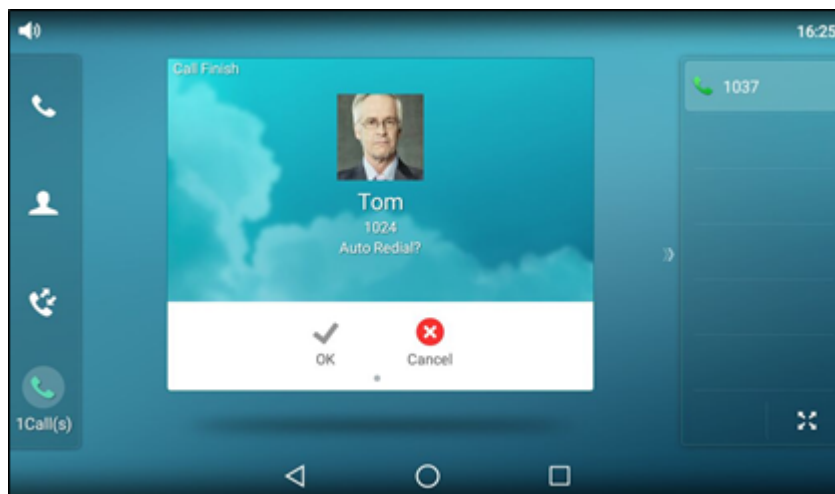

2. Wait for the designated period of time or tap **OK** to redial the phone number immediately.
The phone will retry as many times as configured until the callee answers the call.

Related Topic

[Setting the Auto Redial](#)

Call Mute

You can mute the microphone of the active audio device during an active call so that the other party cannot hear you.

Call mute applies to all modes (Handset, Headset and Speakerphone).

Topics

[Muting/Unmuting Audio](#)

[Keep Mute](#)

Muting/Unmuting Audio

When you are in a call, you can mute the audio, so that you can hear the other person, but he/she cannot hear you.

Procedure

1. Press the MUTE key during a call.
2. Press the MUTE key again to unmute the call.

Tip

You can also mute the microphone while the phone is dialing or ringing, so that the other party cannot hear you when the call is set up.

Keep Mute

In a call center or meet room, if incoming calls are answered automatically, the callers may hear your discussion with your colleagues. You can mute the phone in an idle state to prevent this unintended situation. The mute state of your phone persists across calls. The phone stays in the mute state until you unmute the microphone manually or until the phone restarts.

Before You Begin

Check with your system administrator if keep mute is configured on your phone.

Procedure

1. Press the MUTE key when the phone is idle.
The mute key LED glows red.

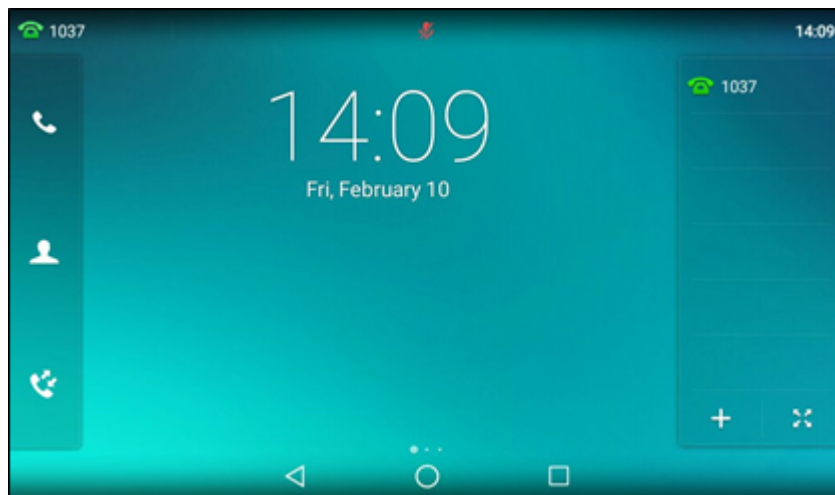

2. Press the MUTE key again to deactivate the mute state.

Call Hold

You can place an active call on hold and resume the call when you are ready. When you place a call on hold, your IP PBX may play music to the other party while waiting.

Topics

[Holding a Call](#)

[Resuming a Held Call](#)

[Swapping Between Active and Held Calls](#)

Holding a Call

Procedure

1. Press the HOLD key or tap **Hold** during a call.
The phone screen indicates that the call is on hold.

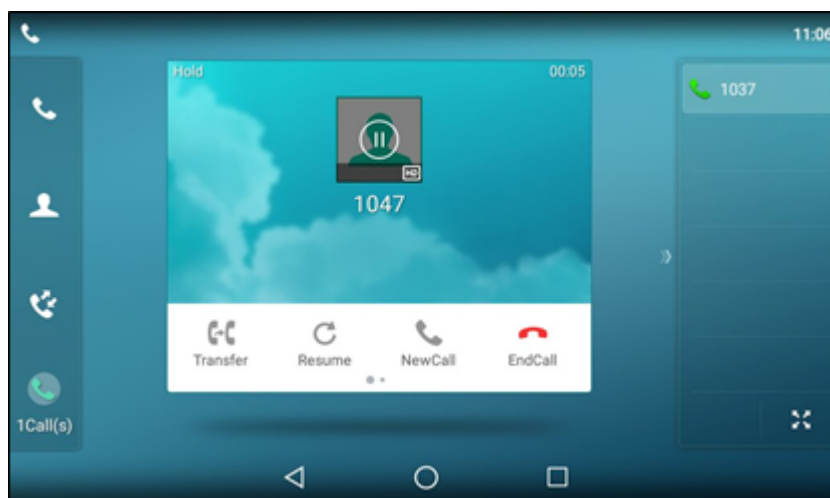

Resuming a Held Call

Procedure

1. Press the HOLD key or tap **Resume**.
If multiple calls are placed on hold, select the desired call first.

Swapping Between Active and Held Calls

You can easily switch between active and held calls.

Procedure

1. Tap the desired call directly.

Do Not Disturb (DND)

DND enables your phone to reject all incoming calls automatically when you do not want to be interrupted. You can enable DND globally on the phone or enable DND for specific lines.

If you want to receive specific numbers when DND is enabled, you can ask your system administrator to set DND Authorized Numbers.

Note

Check with your system administrator to find out if the DND feature is available on your phone.

Topics

- [Rejecting Calls with DND on All Lines](#)
- [Rejecting Calls with DND on Specific Lines](#)
- [Deactivating DND](#)

Rejecting Calls with DND on All Lines

You can activate DND for all the lines on your phone. The phone will reject all incoming calls automatically.

Note

If both DND and busy forward are activated on the phone, calls will be forwarded to the configured destination number.

Procedure

1. Do one of the following:
 - Swipe down from the top of the screen to enter the control center and toggle **DND** on.
 - Swipe left/right to go to the second idle screen, and then navigate to **Settings->Features->DND**. Tap **On** radio box of the **DND Status** field.

3. Tap  .

The DND icon appears in the status bar.



Related Topics

- [Deactivating DND](#)
- [Icons in the Status Bar](#)
- [Redirecting Incoming Calls](#)

Rejecting Calls with DND on Specific Lines

By default, the DND feature applies to all lines on your phone. Your system administrator can change the DND mode to Custom so that you can enable DND for specific lines.

Before You Begin

The DND mode is set to Custom. Check with your system administrator if the DND on code or off code is required. If required, get it from your system administrator.

Procedure

1. Do one of the following:
 - Swipe down from the top of the screen to enter the control center and tap **DND**.
 - Swipe left/right to go to the second idle screen, and then navigate to **Settings->Features->DND**.
2. Select the desired line.
3. Tap the **On** radio box in the **DND Status** field.
4. (Optional.) Enter the DND on code or off code respectively in the **On Code** or **Off Code** field.
5. Tap .

The DND icon appears on the desired line. If you activate DND on the default line, the DND icon will appear both on the line and in the status bar.

Tip

Before selecting a line, you can tap  -> **All On** to activate DND for all lines.

Related Topics

[Deactivating DND](#)
[Icons in the Status Bar](#)
[Line Key Icons](#)

Deactivating DND

You can deactivate DND when you are ready to resume receiving calls again.

Procedure

1. Swipe left or right to go to the second idle screen.
2. Navigate to **Settings->Features->DND**.
3. (Optional) If you are in Custom mode, select the desired line.
4. Tap the **off** radio box in the **DND Status** field.
4. Tap .

The DND icon disappears.

Tip

You can also swipe down from the top of the screen to enter the control center and then tap **DND** to deactivate DND. You can tap  -> **All off** at the top right to deactivate DND for all lines when deactivating it for a specific line.

Related Topics

[Rejecting Calls with DND on All Lines](#)
[Rejecting Calls with DND on Specific Lines](#)

Redirecting Incoming Calls

You can redirect incoming calls by forwarding all incoming calls to a contact, forwarding an incoming call manually or forwarding incoming calls with a forward key.

Topics

[Forwarding All Incoming Calls to a Contact](#)

[Forwarding an Incoming Call Manually](#)

[Forwarding Incoming Calls with a Forward Key](#)

Forwarding All Incoming Calls to a Contact

You can set up your phone to forward all incoming calls to a contact with one of the following types:

- **Always Forward:** Forwards all incoming calls immediately.
- **Busy Forward:** Forwards incoming calls when you are busy in a call.
- **No Answer Forward:** Forwards incoming calls when no one answers the calls.

Topics

[Forwarding All Incoming Calls on All Lines](#)

[Forwarding All Incoming Calls on Specific Lines](#)

[Deactivating Call Forward](#)

Forwarding All Incoming Calls on All Lines

Before You Begin

Check with your system administrator if the forward on code or off code is required. If required, get it from your system administrator.

Procedure

1. Swipe left/right to go to the second idle screen.
2. Navigate to **Settings**->**Features**->**Call Forward**.
3. Select the desired forwarding type and tap the **On** radio box of the corresponding field.
3. Enter the contact number you want to forward incoming calls to in the **Forward to** field.
4. If you select the **No Answer Forward** option, select the desired ring time to wait before forwarding from the **After Ring Time** field.
5. (Optional.) Enter the always/busy/no answer forward on code or off code respectively in the **On Code** or **Off Code** field.
6. Tap .

The call forward icon  on the Idle screen indicates that the call forward is activated.

Tip

You can also swipe down from the top of the screen to enter the control center, tap **Forward** to enter the desired Call Forward setting screen according to the current forward type.

If you have not configured the call forward type, tapping **Forward** will turn to the Always Forward setting screen.

Forwarding All Incoming Calls on Specific Lines

By default, the forward setting applies to all lines on your phone. Your system administrator can change the forward mode to Custom so that you can set Forward setting for specific lines.

Before You Begin

The call forward mode is set to Custom. Check with your system administrator if the forward on code or off code is required. If required, get the forward on code or off code from your system administrator.

Procedure

1. Swipe left/right to go to the second idle screen.
2. Navigate to **Settings**->**Features**->**Call Forward**.
3. Select the desired line.
4. Select the desired forwarding type and tap the **On** radio box of the corresponding field.
4. Enter the contact number you want to forward incoming calls to in the **Forward to** field.
5. If you select the **No Answer Forward** option, select the desired ring time to wait before forwarding from the **After Ring Time** field.
6. (Optional.) Enter the always/busy/no answer forward on code or off code respectively in the **On Code** or **Off Code** field.
7. Tap .

The forward icon appears on the desired line. If you activate forward on the default line, the forward icon will appear both on the line and in the status bar.

Tip

You can tap  -> **All Lines** to activate forward for all lines.

Deactivating Call Forward

You can deactivate call forward when you no longer want to forward your calls.

Procedure

1. Swipe left/right to go to the second idle screen.
2. Navigate to **Settings**->**Features**->**Call Forward**.
3. If the forward is activated for specific lines, select the desired line.
4. Select the desired forwarding type and tap the **Off** radio box.
5. Tap .

Tip

You can tap  at the top right and then tap **All Lines** to deactivate forward for all lines.

Forwarding an Incoming Call Manually

You can manually forward the call to another contact while your phone rings.

Procedure

1. When the phone is ringing, tap **Forward**.
2. Enter the number you want to forward the incoming call to.

3. Tap **Forward.**

The phone screen prompts a call forward message.

Forwarding Incoming Calls with a Forward Key

By default, when the phone receives an incoming call, you can easily tap the Forward key to forward the incoming call to a specific contact.

Topics

[Setting a Forward Key](#)

[Forwarding Incoming Calls Using a Forward Key](#)

Setting a Forward Key

You can set a line key as a Forward key, and specify a contact you want to forward the incoming calls to for this key.

Procedure

1. Swipe left or right to go to the second idle screen.
2. Navigate to **Settings**->**Features**->**Dsskey**.
3. Select the desired line key.
4. Select **Key Event** from the **Type** field.
5. Select **Forward** from the **Key Type** field.
6. (Optional.) Enter the string that will display on the phone screen in the **Label** field.
7. Enter the contact number you want to forward the incoming calls to in the **Value** field.
8. Tap  .

Tip

You can drag the line key to the **Edit** field to set a Forward key.

Forwarding Incoming Calls Using a Forward Key

Before You Begin

You need to set a Forward key with a specific contact. Make sure your system administrator has set the forward mode to Phone.

Procedure

1. When the phone is ringing, tap the forward key to quickly forward the call to the specific contact.

Transferring Calls

During a call, you can transfer the call to another contact in one of three ways:

- **Blind Transfer:** Transfer a call directly to the third party without consulting.
- **Semi-Attended Transfer:** Transfer a call when receiving ringback.
- **Attended Transfer (Consultative Transfer):** Transfer a call with prior consulting.

Topics

[Performing a Blind Transfer](#)

[Performing a Semi-Attended/Attended Transfer](#)

[Performing Transfer with a Transfer Key](#)

Performing a Blind Transfer

You can transfer a call to another contact immediately without consulting with her/him first.

Topics

[Performing a Blind Transfer Normally](#)

[Performing a Blind Transfer Conveniently](#)



Performing a Blind Transfer Normally

Procedure

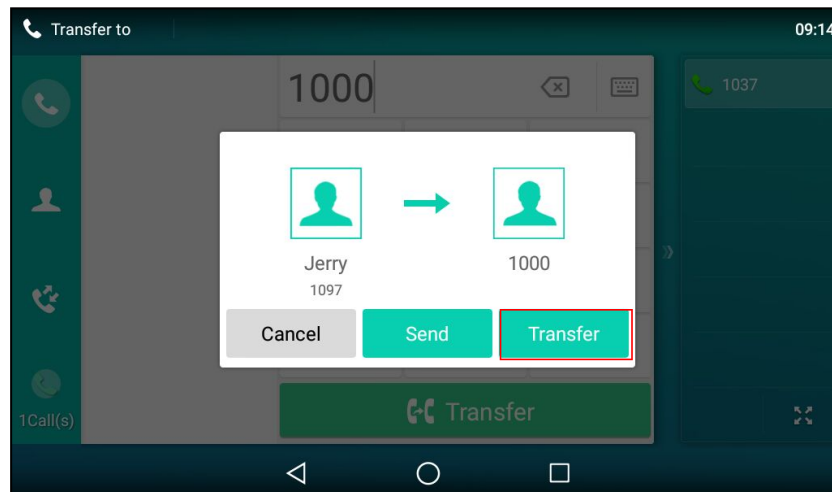
1. Press the TRANSFER key or tap the **Transfer** soft key during a call.
2. Do one of the following:
 - Enter the number you want to transfer the call to, and then press the TRANSFER key or tap **Transfer**.
The phone will prompt a dialog box as the following shows:



Tap **Transfer** to complete the transfer. (The call will automatically dial out in about 5 seconds if you do not tap **Transfer**.)

- Tap , and then select the desired contact to complete the transfer.
- Tap , and then select the desired list. Tap the desired entry to complete the transfer.

Performing a Blind Transfer Conveniently

Procedure

You can do one of the following:

- When there is an active call for the account selected from the **Account ID** field on the speed dial or BLF key. Drag the far-site window to that speed dial or BLF key.

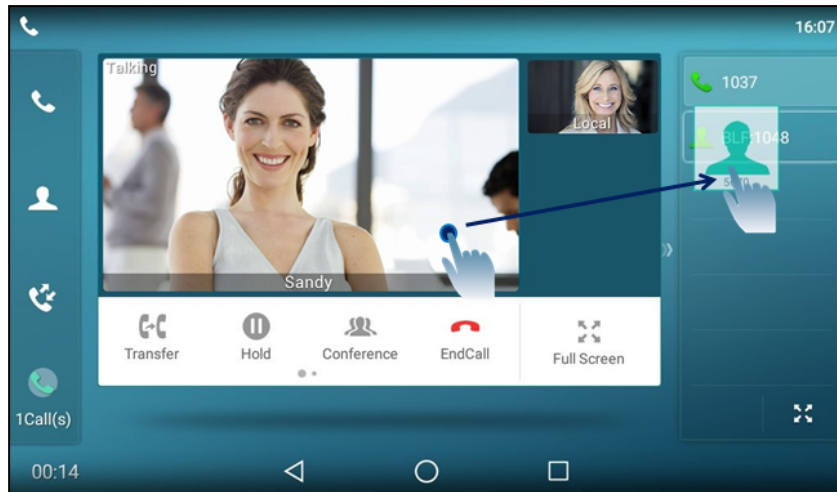

SIP-T58V/A

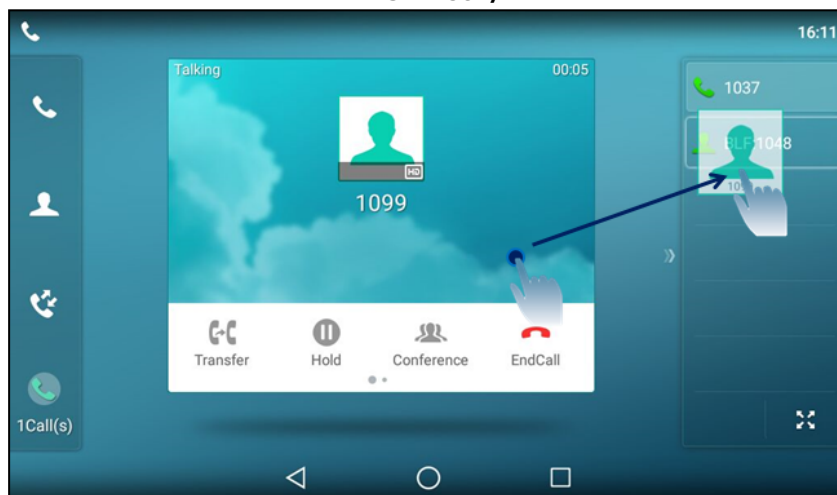

SIP-T56A

Then the call is connected to the number specified in the **Value** field of the speed dial or BLF key.

- When there is an active call and one or more calls on hold, drag one far-site window to another far-site window.

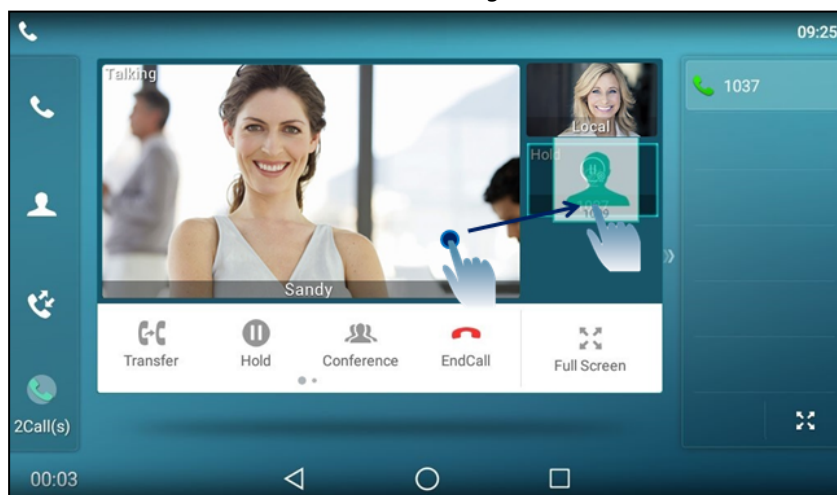

SIP-T58V/A

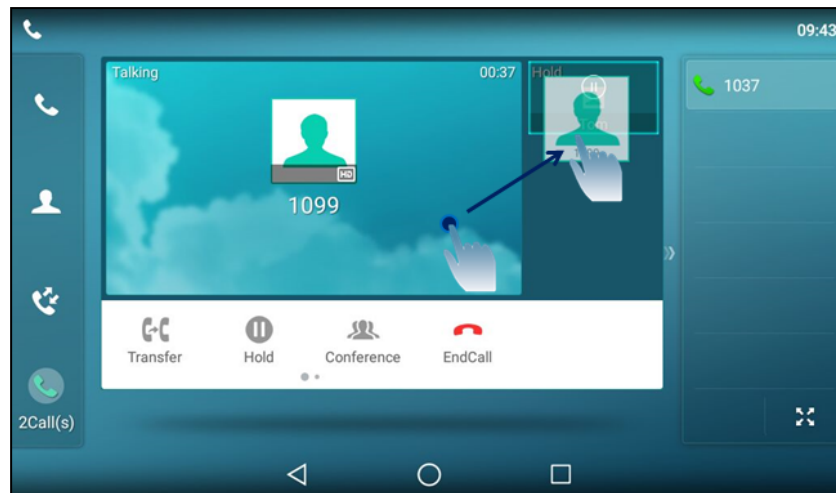

SIP-T56A

And then tap **Transfer** from the screen.

The active call is connected to the number of the held party.

Related Topics



[Setting a BLF Key](#)

[Setting a Speed Dial Key Manually](#)

Performing a Semi-Attended/Attended Transfer

You can transfer calls to other contacts immediately when receiving ringback or after consulting with them first.

Procedure

1. Press the TRANSFER key or tap **Transfer** during a call.
2. Do one of the following:
 - Enter the number you want to transfer the call to.
Tap **Transfer**->**Send** to dial out.
 - Tap , and then select the desired contact group and tap the desired contact to dial out.
 - Tap , and then select the desired list. Tap the desired entry to dial out.
3. Do one of the following:
 - When you hear the ringback tone, press the TRANSFER key or tap **Transfer** to finish a semi-attended transfer.
 - After the contact answers the call, press the TRANSFER key or tap **Transfer** to finish an attended transfer (consultative transfer).

Tip

If you are using a handset, the transfer can be completed by hanging up the handset.

Related Topics

[Setting a Speed Dial Key Manually](#)

[Performing Transfer with a Transfer Key](#)

Performing Transfer with a Transfer Key

By default, you can transfer a call to a specific contact directly using a Transfer key during a call. Your system administrator can also set your phone to perform attended transfer when using a Transfer key.

Topics

[Setting a Transfer Key](#)

[Performing a Blind Transfer Using a Transfer Key](#)

[Performing a Semi-Attended/Attended Using a Transfer Key](#)

Setting a Transfer Key

You can set a line key as a Transfer key, and specify a contact you want to transfer a call to for this key.

Procedure

1. Swipe left or right to go to the second idle screen.
2. Navigate to **Settings**->**Features**->**Dsskey**, and then select the desired line key.
3. Select **Key Event** from the **Type** field.
4. Select **Transfer** from the **Key Type** field.
5. (Optional.) Enter the string that will display on the touch screen in the **Label** field.
6. Enter the contact number you want to transfer the call to in the **Value** field.
5. Tap  .

Tip

You can drag the line key to the **Edit** field to set a Transfer key.

Performing a Blind Transfer Using a Transfer Key

Before You Begin

You need to set a Transfer key with a specific contact. By default, your system administrator has set your phone to perform blind transfer by Transfer key.

Procedure

1. Tap the Transfer key during a call.
The call is transferred to the specific contact directly.

Related Topic

[Setting a Transfer Key](#)

Performing a Semi-Attended/Attended Using a Transfer Key

Before You Begin

You need to set a Transfer key with a specific contact. Your system administrator has set your phone to perform attended transfer by Transfer key.

Procedure

1. Tap the Transfer key during a call.

The phone calls the specific contact first. Wait until you hear the ringback tone or until the contact answers the call.

2. Tap the Transfer key again.

Related Topic

[Setting a Transfer Key](#)

Conference Calls

The Yealink IP phones support a five-way local conference and multi-way network conference.

Note

Network conference is not available on all servers. Check with your system administrator to find out if it is available on your phone.

Topics

[Local Conference](#)

[Network Conference](#)

Local Conference

The IP phones support up to 5 parties (including yourself) in a conference call.

For SIP-T58V/A IP phones, you can create up to five-way audio-only and video mixed conference including a maximum of three-way video calls. The following figure shows what the touch screen looks like in a mixed conference call with three-way video calls and two-way audio-only calls:

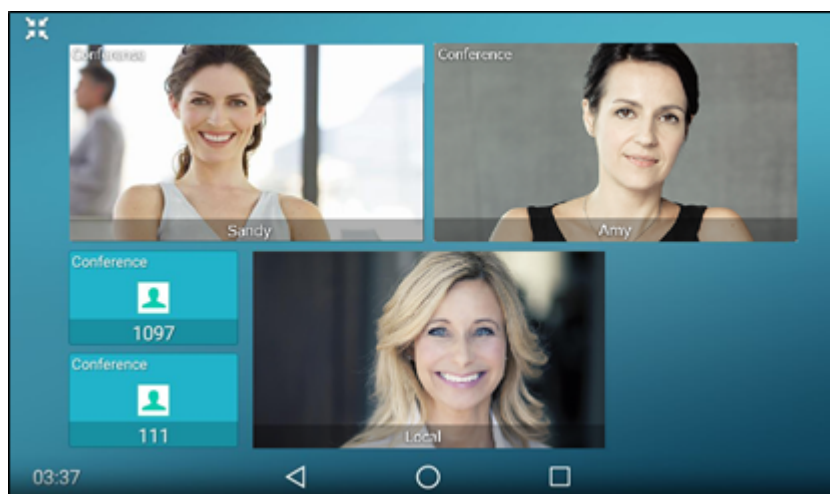

Topics

[Setting Up a Local Conference Call](#)

[Joining Two Calls in a Conference](#)

[Creating a Hybrid Conference](#)

[Holding or Resuming a Conference Call](#)

[Muting or Unmuting a Conference Call](#)

[Splitting a Conference Call](#)

[Managing Conference Participants](#)

[Ending a Conference Call](#)

Setting Up a Local Conference Call

Procedure

1. Place a call to the first party.
2. When the first party answers the call, tap **Conference** to place a new call.
3. Enter the number of the second party to dial out.
The active call is placed on hold.
4. When the second party answers the call, tap **Conference** again to join all parties in the conference.

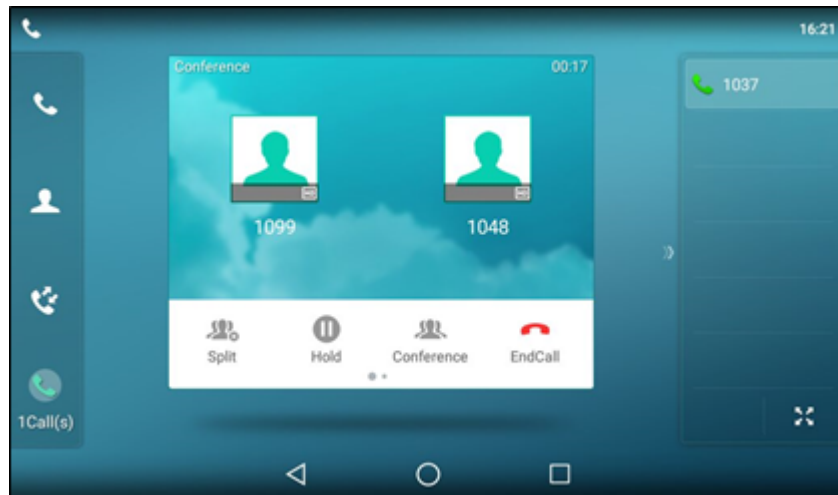

Joining Two Calls in a Conference

You can invite a held call into a conference call with the active call.

Procedure

1. Place two or more calls using the same or different accounts on the phone.
2. Do one of the following:
 - Drag one far-site window to another far-site window.

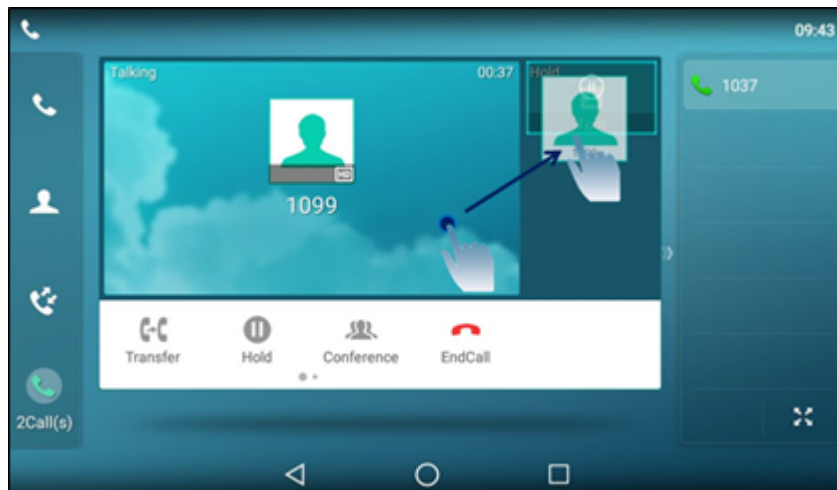

And then tap **Conference** from the pop-up box.

- Tap the desired call for a conference and ensure that the call is active.

Tap **Conference**.

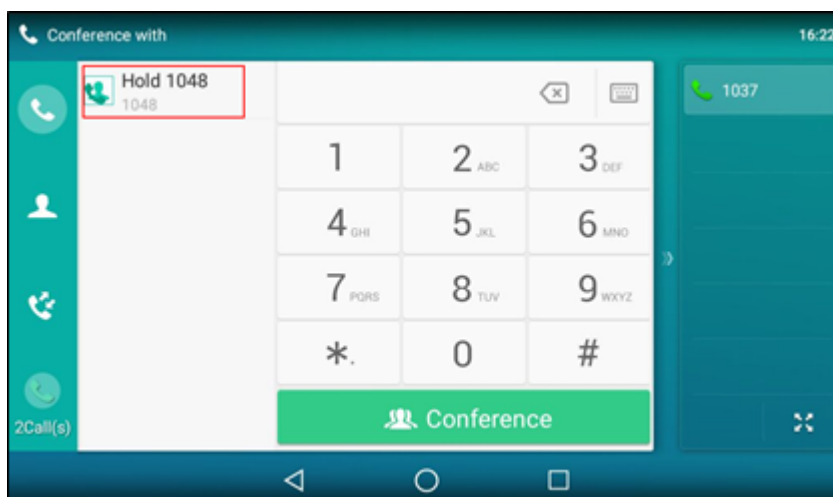

Tap the Hold call to join the calls in the conference.

Creating a Hybrid Conference

You can merge the calls on your IP phones, and connected mobile phone into to a hybrid conference. There are many ways to create a hybrid conference, the following shows an example.

Before You Begin

Make sure you have connected a mobile phone to your IP phone.

Procedure

1. Place a mobile call over Bluetooth on the mobile phone.
2. Place a call on the IP phone.
3. Tap **Conference**.
4. Tap the hold call.

The calls are merged into a conference call.

Related Topics

[Pairing and Connecting the Bluetooth-Enabled Mobile Phone](#)
[Handling a Mobile Phone Call on the IP Phone](#)

Holding or Resuming a Conference Call

When you place a conference call on hold, other participants are placed on hold. Other participants cannot hear each other until you resume the held conference call.

Procedure

1. Press the HOLD key or tap **Hold** to place the conference on hold.
2. Press the HOLD key again or tap **Resume** to resume the held conference call.

Muting or Unmuting a Conference Call

You can mute the local microphone during a conference call so that the other participants can hear each other except you.

Procedure

1. Press the MUTE key to mute the conference.
2. Press the MUTE key again to unmute the conference.

Splitting a Conference Call

You can split the conference call into individual calls. After you split a conference call, the conference call ends, and other parties are held. You can resume one of the hold calls.

Procedure

1. Tap **Split**.

Managing Conference Participants

You can manage conference participants in the following ways:

- Mute a participant
- Remove a participant from the conference

Procedure

Long tap the desired party, you can do the following:

- Tap **Far Mute** to mute the party. The muted party can hear everyone, but no one can hear the muted party.
- Tap **Remove** to remove the party from the conference call.
- Tap **Cancel** to close the dialog box.

Ending a Conference Call

By default, other parties drop the call when you end the conference call. However, your system administrator can set up that the other two parties remain connected when you end the conference call.

Procedure

1. Tap **End Call** to drop the conference call.

Network Conference

If your system administrator has set a network conference feature on your phone, you can initiate a conference with multiple participants.

Topics

[Setting Up a Network Conference](#)

Setting Up a Network Conference

Procedure

1. Place a call to the first party.
2. Tap **Conference** to place a new call.
The active call is placed on hold.
3. Enter the number of the second party, and then tap **Conference**.
4. When the second party answers the call, tap **Conference** to add the second party to the conference.
5. Tap **Conference** to place a new call.
The conference call is placed on hold.

6. Enter the number of the new party, and then tap **Conference**.
7. When the new party answers the call, tap **Conference** to add the new party to the conference.
8. Repeat steps 5 to 7 until you add all parties.

The conference is set up after the intended parties answer the call.

Note

The procedures for setting up a network conference call on specific servers may be different from the introduction above. Contact your system administrator for more information.

Call Recording

By default, the recorded files are saved in the internal SD card. But if there is a USB flash drive connected to your phone, the recorded files will be saved in the storage device according to the priority: USB flash drive>internal SD card.

Note

For more information on how to attach a USB flash drive, please refer to the Quick Start Guide for your IP phone on your phone's support page on [Yealink Support](#).

You can record up to 12 hours in one file.

Topics

- [Recording a Call](#)
- [Recording a Conference](#)
- [Managing a Call While Recording](#)
- [Playing a Recorded Call](#)
- [Pause/Resuming a Playback](#)
- [Fast Forwarding/Rewinding a Playback](#)
- [Stopping a Playback](#)
- [Deleting a Recorded File](#)
- [Checking Storage Space](#)

Recording a Call

You can record active calls on the phone. You cannot record calls when there are no connected calls, when you place a new call, transfer a call or initiate a conference, or when you have an incoming call.

Important

Before call recording, especially those involving PSTN, it is necessary to know about the rules and restrictions of any governing call recording in the country where you are.

It is also very important to inform all the call parties that you are recording and ask for their consent before recording the conversation.

Procedure

1. During a call, swipe the soft key area left and then tap the **Record** soft key.
The phone screen displays a recording icon and recording duration.

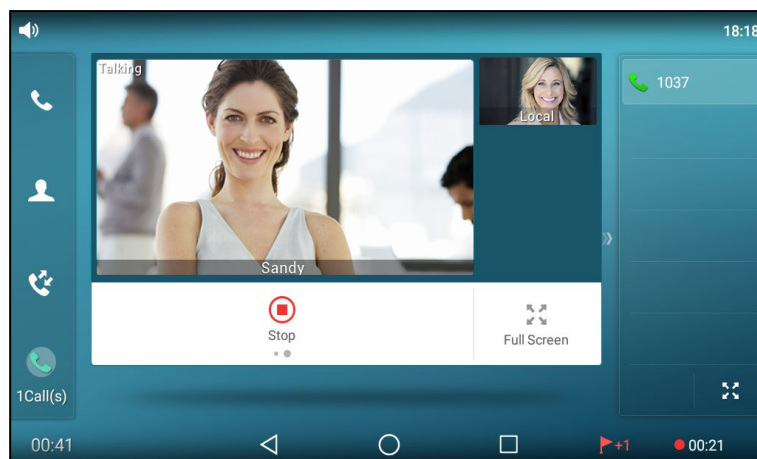

Recording a Conference

You can record conference calls in the same way as other calls with the following exceptions:

- All conference participants are recorded while recording. If one of the participants taps the **Hold** soft key or press the HOLD key, only that participant is recorded. When a conference call is placed on hold, recording of the conference is paused. You can place or answer other calls, which will be recorded in the same file. When the conference call is resumed, recording of the conference resumes.
- All conference participants are recorded while recording. If one of the participants presses the MUTE key only that participant is not recorded.

Managing a Call While Recording

You can hold/resume, mute, transfer, place a new call or set up a conference call during recording. All calls you handle during a recording are recorded in the same file.

If your call is placed on hold, the recording is paused. It means that both you and the remote party are not recorded. If you mute the call, the muted party is not recorded.

Setting a Mark When Recording a Call

You can set a mark to when recording a call to mark the special moment. And there will be a red flag on this moment when playing the recorded file so that you can drag to the moment quickly.

Procedure

1. Tap .

The icon changes to , the number will increase if you set more marks.

Stopping a Recording

You can stop recording during a call. When you end a call during recording, the recording will also be stopped and saved as *.aac file in the internal SD card or the USB flash drive automatically.

Procedure

1. Do one of the following:
 - Swipe the soft key area left and then tap **Stop** during a call.
The recording icon and recording duration disappears. A message is displayed, prompting that the call is recorded successfully.

- Tap **End Call**.

The recording icon and recording duration disappears, and the phone returns to the Idle screen. A prompt message is displayed, prompting that the call is recorded successfully.

Playing a Recorded Call

You can browse and play back the recorded files on your phone.

The recorded calls include a date & time stamp and the other party's number/IP address/name (or the first person's number/IP address/name you called), for example, 20160302-1452-Tom was created on March 2, 2016, at 14:52 and you have a call with Tom. The recorded audio-only calls are saved in *.aac format and the recorded video calls are saved in *.mkv format. You can view the recorded files by **Recorder** or **File Manager** application. The following is an example of playing the recorded call using the **Recorder** application.

Tip

You can also play back the recorded calls on the phone or on a computer using an application capable of playing files.

Procedure

1. Swipe left or right to go to the second idle screen.

2. Tap  to launch the **Recorder** application.

The touch screen shows all recorded files in the **Audio Recorder** list.

3. Tap  before the desired recorded call to play the recorded call.

The length of the recording and a progress bar are displayed as the recording plays.

You can press the Volume key to adjust the volume of audio output.

Related Topics

[Switching Among the Handset, Speakerphone and Headset Modes](#)

[Adjusting the Audio Volume](#)

[Viewing Files](#)

Pause/Resuming a Playback

When you receive an incoming call while playing a recording, the recording is paused automatically. You can resume the playback after handling the call. You can also pause the recording manually at any time.

Procedure

1. Tap  to pause playing the recording. The  appears on the touch screen.

2. Tap  to resume the playback.

Fast Forwarding/Rewinding a Playback

While a recorded audio or call plays, you can fast forward or rewind the playback at any time.

Procedure

1. Drag the slider to skip forward the playing or rewind the playing.

If you have set marks for the recorded audio, you can drag the slider to the position with a red flag to listen to the marked moments.

Stopping a Playback



Procedure

1. Tap  to stop the playing.

Deleting a Recorded File

You can delete local recordings or call recordings in **Recorder** application. The local recorded audios are named of a prefix "record@" and date & time stamp, while the call recordings are named of the date & time stamp.

Procedure

1. Swipe left or right to go to the second idle screen.
2. Tap  to launch the **Recorder** application.
The touch screen shows all recorded files in the **Audio Recorder** list.
3. Tap  after the desired recorded audio.
4. Tap **Delete**.
The phone screen prompts you whether to delete the audio.
5. Tap **OK**.

Checking Storage Space

You can check the storage space (e.g., total space, available space) of the IP phone or connected USB flash drive.

Procedure

1. Swipe left or right to go to the second idle screen.
2. Navigate to **Settings**->**Status**->**Storage**.

Multicast Paging

Multicast Paging allows you to easily and quickly broadcast instant audio announcements to users who are listening to a specific multicast group on a specific channel.

The IP phone supports the following 31 channels:

- **0**: Broadcasts are sent to channel 0. Note that the Yealink IP phones running old firmware version (old paging mechanism) can be regarded as listening to channel 0. It is the default channel.
- **1 to 25**: Broadcasts are sent to channel 1 to 25. We recommend that you specify these channels when broadcasting with Polycom IP phones which have 25 channels you can listen to.
- **26 to 30**: Broadcasts are sent to channel 26 to 30. We recommend that you specify these channels when broadcasting with Yealink IP phones running new firmware version (new paging mechanism).

Note that all IP phones in the multicast paging group must be deployed in the same network, since a broadcast is used. The IP phone can only send/receive broadcasts to/from the listened channels. Other channels' broadcasts will be ignored automatically by the IP phone.

Topics

- [Sending Multicast Paging](#)
- [Receiving Multicast Paging](#)
- [Managing a Paging Call](#)

Sending Multicast Paging

Yealink IP phone supports up to 31 groups for paging. You can assign a label to each group to identify the phones in the group, such as All, Sales, or HR.

You can set a line key as Multicast Paging key or Paging list key on the phone, which allows you to send announcements to the phones with pre-configured multicast address(es) on specific channel(s).

Note

Multicast RTP is one way only from the sender to the multicast address(es) (receiver). For outgoing RTP multicasts, all other existing calls on the phone will be placed on hold.

Topics

[Setting a Multicast Paging Key](#)

[Setting a Paging List Key](#)

[Setting a Paging Group](#)

[Deleting a Paging Group](#)

[Sending a Paging by a Multicast Paging Key](#)

[Sending Pages by a Paging List Key](#)

Setting a Multicast Paging Key

You can set a Multicast Paging key for a paging group, which allows you to send announcements quickly on the idle screen.

Before You Begin

Get the multicast IP address and port number from your system administrator.

Procedure

1. Swipe left or right to go to the second idle screen.
2. Navigate to **Settings**->**Features**->**Dsskey**.
3. Select the desired line key.
4. Select **Key Event** from the **Type** field.
5. Select **Multicast Paging** from the **Key Type** field.
6. (Optional.) Enter the paging group name in the **Label** field.
7. Enter the multicast IP address and port number (for example, 224.5.6.20:10008) in the **Value** field.
8. Enter the desired channel between 0 and 30 in the **Channel** field.
9. Tap  .

Tip

You can drag the line key to the **Edit** field to set a Multicast Paging key.

Setting a Paging List Key

You can set a Paging List key to easily access the paging groups on the idle screen.

Procedure

1. Swipe left or right to go to the second idle screen.
2. Navigate to **Settings**->**Features**->**Dsskey**.

3. Select the desired line key.
4. Select **Key Event** from the **Type** field.
5. Select **Paging List** from the **Key Type** field.
6. (Optional.) Enter the string that will display on the phone screen in the **Label** field.
7. Tap .

Tip



You can drag the line key to the **Edit** field to set a Paging List key.

Setting a Paging Group

Before You Begin



Get the multicast IP address and port number from your system administrator.

Procedure

1. Tap the paging list key when the phone is idle.
If the paging list key is not configured, you can also swipe left/right to go to the second idle screen. And then navigate to **Settings->Features->Paging List** to configure the paging list.
2. Tap  after the desired paging group.
The default tag is Empty if it is not configured before.
3. Enter the multicast IP address and port number (for example, 224.5.6.20:10008) in the **Address** field.
4. Enter the string that will display on the phone screen in the **Label** field.
5. Enter the desired channel between 0 and 30 in the **Channel** field.
6. Tap .
7. To set more paging groups, repeat steps 2 to 6.

Deleting a Paging Group

Procedure

1. Tap the paging list key when the phone is idle.
If the paging list key is not configured, you can also navigate to **Settings->Features->Paging List** to configure the paging list.
2. Tap  after the desired paging group.
3. Tap **Delete**.
The phone screen prompts you whether to delete the paging group.
4. Tap **OK**.
If you want to delete all paging groups, you can tap  on the top-right of the touch screen.

Sending a Paging by a Multicast Paging Key

Before You Begin

You need to set a Multicast Paging key in advance.

Procedure

1. Tap the Multicast Paging key when the phone is idle.

Both your phone and receiver's phone play a warning tone and the multicast RTP session will be automatically answered on the receiver's phone in the speakerphone (hands-free) mode.

The multicast paging key icon will become  and solid.

The following figure shows a multicast RTP session on the phone:

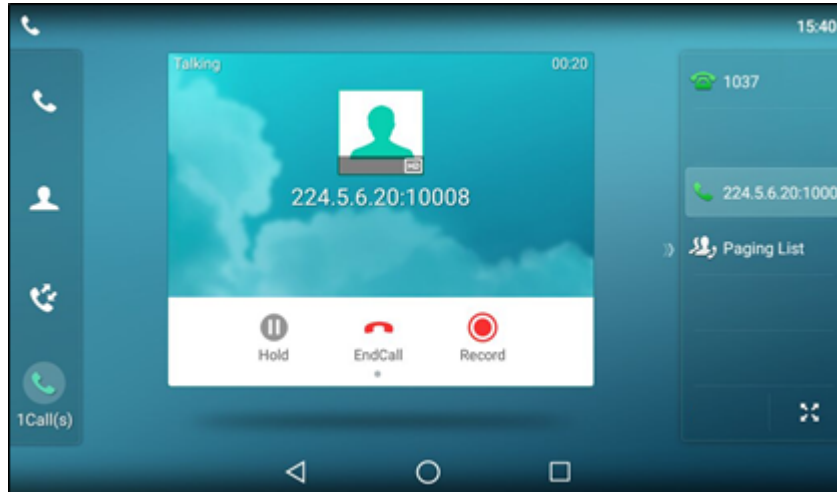

Related Topic

[Setting a Multicast Paging Key](#)

Sending Pages by a Paging List Key

Before You Begin

You need to set a Paging List key in advance.

Procedure

1. Tap the paging list key when the phone is idle.
2. Tap the desired paging group.

Both your phone and receiver's phone play a warning tone and the multicast RTP session will be automatically answered on the receiver's phone in the speakerphone (hands-free) mode.

Related Topic

[Setting a Paging List Key](#)

Receiving Multicast Paging

Your system administrator has set a listening paging group for you, and then you can receive a paging call when the phone is idle. The paging call is automatically answered on your phone.

When there is a voice call or a paging call in progress, the phone handles the new paging call differently according to the multicast listening settings configured by your system administrator.

Managing a Paging Call

During a paging call, you can do the following:

- Tap **Hold** to place the current paging call on hold.

The paging call is placed on hold and the receiver releases the session.

- Tap **Resume** to resume the held paging call.

The multicast RTP session is re-established.

- Tap **Record** to record a call.
- Tap **End Call** to end the paging call.

Advanced Features

This chapter explains how to use the advanced features on the IP phone.

Topics

[Call Completion](#)
[Call Pickup](#)
[Call Park and Call Retrieve](#)
[Busy Lamp Field \(BLF\)](#)
[BLF List](#)
[Shared Line](#)
[Intercom](#)
[Video/Voice Mail](#)
[Hot Desking](#)
[Automatic Call Distribution \(ACD\)](#)

If you require additional information or assistance with your new phone, contact your system administrator.

Call Completion

When you place a call and the callee is temporarily unavailable to answer the call, call completion allows your phone to monitor the busy party and establish a call after the busy party becomes available to receive a call.

Note

Call completion is not available on all servers. For more information, contact your system administrator.

Topics

[Enabling Call Completion](#)
[Using Call Completion](#)

Enabling Call Completion

Procedure

1. Swipe left/right to go to the second idle screen.
2. Navigate to **Settings**->**Features**->**Call Completion** .
3. Turn on **Call Completion**.
4. Tap  .

Using Call Completion

Before You Begin

Enable call completion feature on the phone. You place a call and the callee is temporarily unavailable to answer the call.

Procedure

1. The phone screen prompts whether to wait for the callee, tap **OK** to activate the call completion feature.

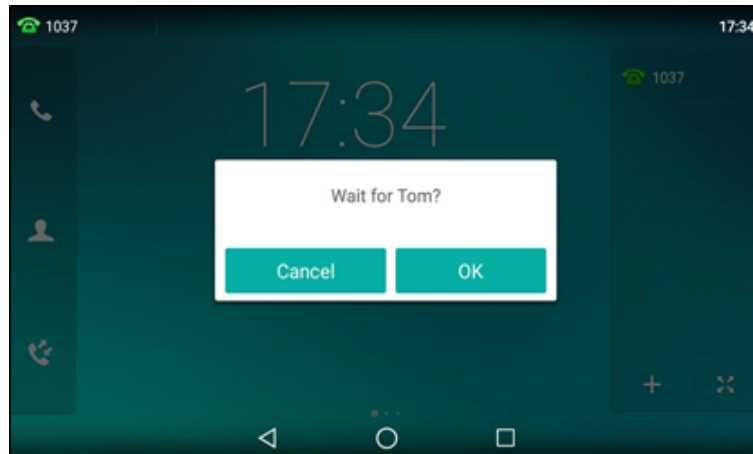

2. When the callee becomes idle, the phone screen prompts whether to dial the number, tap **OK** to dial the number.

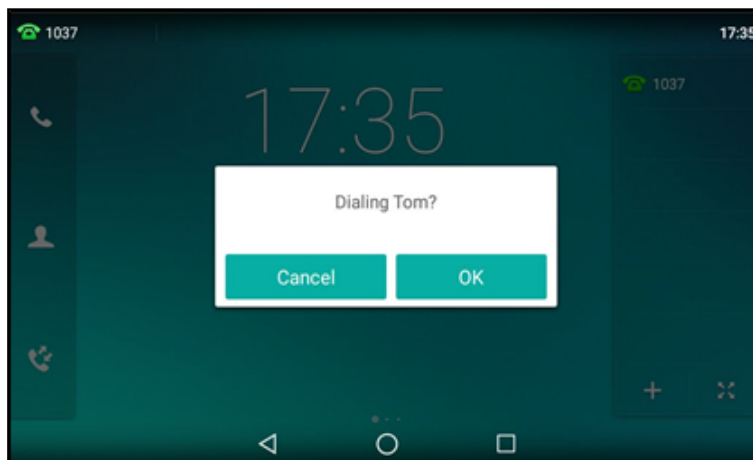

Related Topic

[Enabling Call Completion](#)

Call Pickup

You can use call pickup to answer someone else's incoming call on your phone. Check with your system administrator to find out if this feature is available on your phone.

The Yealink IP phone supports Directed Call Pickup and Group Call Pickup.

- **Directed Call Pickup:** allows you to pick up incoming calls from another phone.
- **Group Call Pickup:** allows you to pick up incoming calls to any phone within a predefined group of phones, without dialing the extension of another phone.

Topics

[Picking up a Call Directly](#)

[Picking up a Group Call Directly](#)

[Picking up a Call with a Directed Pickup Key](#)

[Picking up a Call with a Group Pickup Key](#)

Picking up a Call Directly

You can answer a call that rings on another phone.

Before You Begin

The target phone receives an incoming call. Your system administrator has enabled the directed call pickup and set the directed call pickup code.

Procedure

1. Pick up the handset, press the Speakerphone key or tap the line key.
The **DPickup** soft key appears on the phone screen.
2. Tap **DPickup** on your phone.
3. Enter the phone number which is receiving an incoming call.
4. Tap **DPickup** again.
The call is answered on your phone.

Tip

When the phone is idle, you can use a Directed Pickup or BLF/BLF List key to pick up a call to a specific contact directly.

Related Topics

[Picking up a Call with a Directed Pickup Key](#)

[Picking up a Remote Call by BLF Key](#)

[Picking up a Remote Call by BLF List Key](#)

Picking up a Group Call Directly

When any phone within a predefined group of phones receives an incoming call, you can pick up that call easily on your phone. If there are multiple incoming calls on the group at the same time, you can only pick up the first incoming call.

Before You Begin

Your system administrator has enabled the group call pickup and set the group call pickup code.

Procedure

1. Pick up the handset, press the Speakerphone key or tap the line key.
The **GPickup** appears on the phone screen.
2. Tap **GPickup** on your phone when any phone in the group receives an incoming call.
The call is answered on your phone.

Tip

When the phone is idle, you can use a Group Pickup key to pick up a group call directly.

Related Topic

[Picking up a Call with a Group Pickup Key](#)

Picking up a Call with a Directed Pickup Key

You can easily use a Directed Pickup key to pick up a call to a specific contact's phone.

Topics

[Setting a Directed Pickup Key](#)

[Directed Picking up a Call Using a Directed Pickup Key](#)

Setting a Directed Pickup Key

You can set a line key as a Directed Pickup key, and specify a contact you want to pick up a call from for this key.

Before You Begin

Your system administrator has set the directed call pickup code.

Procedure

1. Swipe left or right to go to the second idle screen.
2. Navigate to **Settings**->**Features**->**Dsskey**.
3. Select the desired line key.
4. Select **Key Event** from the **Type** field.
5. Select **DPickup** from the **Key Type** field.
6. Select the desired line from the **Account ID** field.
7. (Optional.) Enter the string that will appear on the touch screen in the **Label** field.
8. Enter the directed call pickup code followed by the specific extension in the **Value** field.
9. Tap  .

Tip

You can drag the line key to the **Edit** field to set a Directed Pickup key.

Directed Picking up a Call Using a Directed Pickup Key

Before You Begin

You need to set a Directed Pickup key. The target phone receives an incoming call.

Procedure

1. Tap the Directed Pickup key.
The call is answered on your phone.

Related Topic

[Setting a Directed Pickup Key](#)

Picking up a Call with a Group Pickup Key

You can easily tap a Group Pickup key to pick up a group call.

Topics

[Setting a Group Pickup Key](#)

[Picking up a Group Call Using a Group Pickup Key](#)

Setting a Group Pickup Key

You can set a line key as a Group Pickup key.

Before You Begin

Check with your system administrator if the group call pickup code is required for this key. If required, get the group call pickup code from your system administrator.

Procedure

1. Swipe left or right to go to the second idle screen.
2. Navigate to **Settings**->**Features**->**Dsskey**.
3. Select the desired line key.
4. Select **Key Event** from the **Type** field.
5. Select **Group Pick Up** from the **Key Type** field.
6. Select the desired line from the **Account ID** field.
7. (Optional.) Enter the string that will appear on the touch screen in the **Label** field.
8. (Optional.) Enter a contact number you want to pick up a call from in the **Value** field.
9. Tap  .

Tip

You can drag the line key to the **Edit** field to set a Group Pickup key.

Picking up a Group Call Using a Group Pickup Key

Before You Begin

You need to set a Group Pickup key. Any phone within a predefined group of phones receives an incoming call.

Procedure

1. Tap the Group Pickup key.
The call is answered on your phone.

Related Topic

[Setting a Group Pickup Key](#)

Call Park and Call Retrieve

You can use this feature to park a call, and then retrieve the call either from your phone or another phone. After you park a call, the call is placed on hold, you can continue the conversation after retrieving it.

The IP phone supports this feature under the following modes:

- **FAC mode:** park the call to the local extension or a desired extension through dialing the park code.
- **Transfer mode:** park the call to the shared parking lot through a blind transfer. For some servers, the system will return a specific retrieve park number (park retrieve code) from which the call can be retrieved after parking successfully.

Note

Call park is not available on all servers. Check with your system administrator to find out if it is available on your phone.

Topics

[Parking or Retrieving a Call in the FAC Mode](#)

[Parking or Retrieving a Call in the Transfer Mode](#)

[Parking or Retrieving a Call with a Park or Retrieve Key](#)

Parking or Retrieving a Call in the FAC Mode

Your system administrator sets the FAC mode in which you can park and retrieve a call on your phone.

Topics

[Parking a Call](#)

[Retrieving a Parked Call in the FAC Mode](#)

Parking a Call

Before You Begin

Your system administrator has set call park in the FAC mode.

Procedure

1. During a call, swipe the soft key area left and then tap **Park**.
The phone will dial the call park code which is pre-configured.
2. Do one of the following:
 - If you want to park the call against the local extension, the # key.
 - If you want to park the call against the desired extension, enter the extension (for example, 4606) where you want to park the call and the # key.

If the call is parked successfully, you will hear a voice prompt that the call is parked.

Tip

You can use a Park key or a BLF key to park a call to a specific contact directly.

Related Topics

[Parking or Retrieving a Call with a Park or Retrieve Key](#)

[Parking or Retrieving a Call by BLF Key](#)

Retrieving a Parked Call in the FAC Mode

Before You Begin

Your system administrator has set call park in the FAC mode. There is a call parked on the extension.

Procedure

1. Pick up the handset, press the Speakerphone key or tap the line key.
2. Tap **Retrieve Park** on the pre-dialing screen.
The phone will dial the park retrieve code which is configured in advance.
3. Follow the voice prompt to retrieve:
 - the # key on the phone where the call is parked.
 - Enter the desired extension followed by # (for example, 4606#) on any phone.

Tip

When the phone is idle, you can use a Retrieve key, BLF key or BLF List key to retrieve a parked call directly.

Related Topics

[Parking or Retrieving a Call with a Park or Retrieve Key](#)

[Parking or Retrieving a Call by BLF Key](#)

[Retrieving a Call by a BLF List Key](#)

Parking or Retrieving a Call in the Transfer Mode

Your system administrator has set the Transfer mode in which you can park and retrieve a call on your phone.

Topics

[Parking a Call in the Transfer Mode](#)

[Retrieving a Parked Call in the Transfer Mode](#)

Parking a Call in the Transfer Mode**Before You Begin**

Your system administrator has set call park in the Transfer mode.

Procedure

1. During a call, swipe the soft key area left and then tap **Park**.
The call will be directly transferred to the shared parking lot.

Tip

You can use a Call Park key to park a call to a specific shared parking lot directly.

Related Topic

[Parking or Retrieving a Call with a Park or Retrieve Key](#)

Retrieving a Parked Call in the Transfer Mode**Before You Begin**

Your system administrator has set call park in the Transfer mode. There is a call parked on the shared parking lot.

Procedure

1. Pick up the handset, press the Speakerphone key or tap the line key.
2. Tap **Retrieve Park** on the pre-dialing screen.
The phone will retrieve the parked call from the shared parking lot.

Tip

When the phone is idle, you can use a Retrieve key to retrieve a parked call directly.

Related Topic

[Parking or Retrieving a Call with a Park or Retrieve Key](#)

Parking or Retrieving a Call with a Park or Retrieve Key

You can easily use a Park key to park a call to a specific extension (if the FAC mode is set) or shared parking lot (if the Transfer mode is set), and quickly retrieve this parked call using a retrieve key.

Topics

[Setting a Park Key](#)

[Parking a Call using a Park Key](#)

[Setting a Retrieve Key](#)

[Retrieving a Parked Call using a Retrieve Key](#)

Setting a Park Key

You can set a line key as a Park key, and specify an extension or a shared parking lot you want to park a call to for this key.

Before You Begin

Check with your system administrator if the FAC or Transfer mode is set on your phone. Check with your system administrator if **Account ID** it is necessary for this key.

Procedure

1. Swipe left or right to go to the second idle screen.
2. Navigate to **Settings**->**Features**->**Dsskey**, and then select the desired line key.
3. Select **Key Event** from the **Type** field.
4. Select **Call Park** from **Key Type** field.
5. (Optional.) Select the desired line from the **Account ID** field.
6. (Optional.) Enter the string that will appear on the touch screen in the **Label** field.
7. Enter the park extension number or the shared parking lot you want to park the call to in the **Value** field.
8. Tap  .

Parking a Call using a Park Key

Before You Begin

You need to set a Call Park key with a specific extension or a shared parking lot.

Procedure

1. During a call, tap the Call Park key.
The call is parked to the desired extension or the shared parking lot directly.

Related Topic

[Setting a Park Key](#)

Setting a Retrieve Key

You can set a line key as a Retrieve key, and specify a parked extension or retrieve lot you want to retrieve a parked call from for this key.

Before You Begin

Check with your system administrator if the FAC or Transfer mode is set on your phone. Check with your system administrator if **Account ID** it is necessary for this key.

Procedure

1. Swipe left or right to go to the second idle screen.
2. Navigate to **Settings**->**Features**->**Dsskey**.
3. Select the desired line key.
4. Select **Retrieve** from the **Type** field.
5. (Optional.) Select the desired line from the **Account ID** field.
6. (Optional.) Enter the string that will appear on the touch screen in the **Label** field.
7. Enter the parked extension or the retrieve lot in the **Value** field.
8. Tap .

Tip

You can drag the line key to the **Edit** field to set a Retrieve key.

Retrieving a Parked Call using a Retrieve Key

Before You Begin

1. There is a call parked on the extension or the shared parking lot.
2. You need to set a Retrieve key with a parked extension or a retrieve lot.

Procedure

1. Tap the Retrieve key when the phone is idle.
The call is retrieved from the parked extension or shared parking lot directly.

Related Topic

[Setting a Retrieve Key](#)

Busy Lamp Field (BLF)

The Busy Lamp Field (BLF) feature enables you to monitor a specific remote line for status changes on the phone.

You can set a line key as a BLF key on the phone to use the BLF feature.

Topics

[Setting a BLF Key](#)

[State Indicator of Remote Line by BLF Key](#)

[Visual Alert for Monitored Lines](#)

[Picking up a Remote Call by BLF Key](#)

[Transferring a Call by BLF Key](#)

[Parking or Retrieving a Call by BLF Key](#)

Setting a BLF Key

You can set a BLF key to monitor a specific line for status changes on the phone.

Procedure

1. Swipe left or right to go to the second idle screen.
2. Navigate to **Settings**->**Features**->**Dsskey**.
3. Select the desired line key.
4. Select **BLF** from the **Type** field.
5. Select the desired line from the **Account ID** field.
6. (Optional.) Enter the string that will display on the touch screen in the **Label** field.
7. Enter the phone number or the extension you want to monitor in the **Value** field.

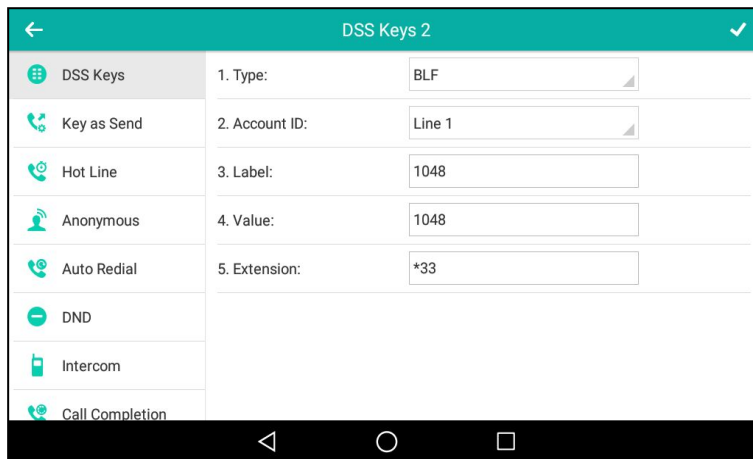







8. Tap .

Note

You can drag the line key to the **Edit** field to set a BLF key.

State Indicator of Remote Line by BLF Key

The following table shows the icon indicator associated with the line you are monitoring.

| Icons | Description |
|---|---|
|  | The monitored line is idle. |
|  | The monitored line is ringing. |
|  | The monitored line is dialing. |
|  | The monitored line is busy or in a call. |
|  | The monitored line places a call on hold. |
|  | The monitored line fails to register or does not exist. |

Visual Alert for Monitored Lines

Your system administrator can enable Visual Alert for BLF Pickup feature, which allows your phone to display the caller ID when the specified monitored line receives an incoming call.

You can pick up the call to the monitored line, place a call to the monitored line, place a new call or go back to the Idle screen.

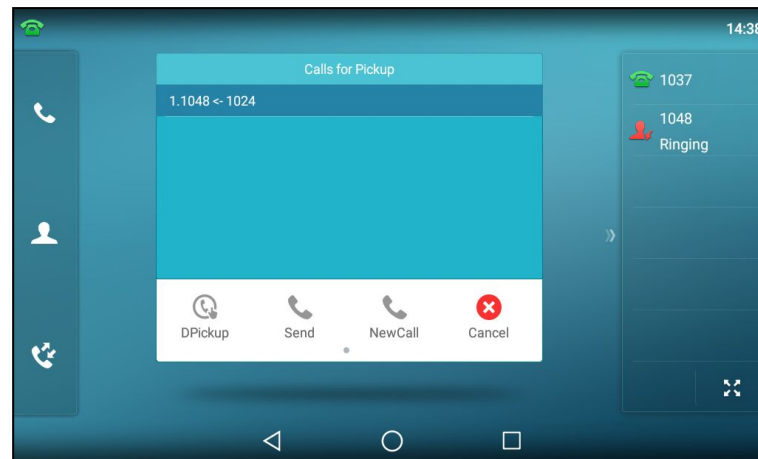

Picking up a Remote Call by BLF Key

When a monitored line receives an incoming call, you can pick up the incoming call by tapping the BLF key. For example, if the monitor users are not at their desks and someone rings their lines, you can pick up the desired call simply by tapping the flashing BLF key.

Before picking up an incoming call, make sure that the directed call pickup code has been configured in advance.

Topics

[Setting the Directed Call Pickup Code for BLF key](#)

[Picking up a Remote Call](#)

Setting the Directed Call Pickup Code for BLF key

If your system administrator set the directed call pickup code in advance, you can use the BLF key to pick up the call directly. If not or if you want to set a pickup code for a specific BLF line, you can set a pickup code for BLF key manually.

Before You Begin

Get the directed call pickup code from your system administrator.

Procedure

1. Drag the BLF key to the **Edit** field.
2. Enter the directed call pickup code in the **Extension** field.
3. Tap .

Related Topic

[Setting a BLF Key](#)

Picking up a Remote Call

When the monitored line receives an incoming call, the BLF icon of the monitored user will become  and flashing.

Before You Begin

Make sure that the directed call pick up code for a BLF key or your system administrator has set the call pickup feature.

Procedure

1. Tap the BLF key to pick up the call for the monitored line directly.

Related Topic

[Setting the Directed Call Pickup Code for BLF key](#)

Transferring a Call by BLF Key

When there is already an active call on the IP phones, you can transfer the active call to the monitored line by tapping the BLF key.

The phone transfers (Blind Transfer or Attended Transfer) the active call differently depending on the Transfer Mode via Dsskey feature configured by your system administrator.

Topics

[Performing a Blind Transfer](#)

[Performing a Semi-attended/Attended Transfer](#)

Performing a Blind Transfer

Before You Begin

Check with your system administrator if the Transfer Mode via Dsskey is set to **Blind Transfer**.

Procedure

1. During a call, tap the BLF key of the monitored line which you want to transfer this call to.

Performing a Semi-attended/Attended Transfer

Before You Begin

Check with your system administrator if the Transfer Mode via Dsskey is set to **Attended Transfer**.

Procedure

1. During a call, tap the BLF key of the monitored line which you want to transfer this call to. The phone will dial out the number of the monitored line.
2. Tap the BLF key of the monitored line again or **Transfer** to complete the transfer when the monitored user receives ringback or after the monitored user answers the call.

Parking or Retrieving a Call by BLF Key

You can use the BLF key to park a call or retrieve a parked call directly.

Note

Check with your system administrator to find out if it is available on your phone.

Topics

[Parking a Call](#)

[Retrieving a Parked Call](#)

Parking a Call

Before You Begin

Your system administrator has set call park feature in the FAC mode in advance.

Procedure

1. During a call, tap **Park**.
2. Tap the desired BLF key to park the call to the monitored line.

Retrieving a Parked Call

Before You Begin

Your system administrator has set call park feature in the FAC mode.

Procedure

1. Tap **Retrieve Park** on the dialing screen.
2. Tap the desired BLF key to retrieve a call that is parked to the monitored line.

BLF List

BLF List feature enables you to monitor a list of users defined by your system administrator. For example, your system administrator has enabled BLF List feature and created a BLF List URI (for example, BLFList@example.com) with user1 and user2 in the list on the server. After configuration, the BLF List keys on the IP phone can present the status of user1 and user2, and the respective icons will either flash or glow depending on the status of monitored lines.

Check with your system administrator to find out if this feature is available on your phone.

Topics

[State Indicator of Remote Line by BLF List Key](#)

[Visual Alert for Monitored Lines](#)

[Picking up a Remote Call by BLF List Key](#)







[Transferring a Call by BLF List Key](#)

[Retrieving a Call by a BLF List Key](#)

[Barging In an Active Call by BLF List Key](#)

State Indicator of Remote Line by BLF List Key

The following table shows the icon indicator associated with the line you are monitoring.

| Icons | Description |
|---|---|
|  | The monitored line is idle. |
|  | The monitored line is ringing. |
|  | The monitored line is dialing. |
|  | The monitored line is busy or in a call. |
|  | A call is parked to the monitored line. |
|  | The monitored line fails to register or does not exist. |

Visual Alert for Monitored Lines

Your system administrator can enable Visual Alert for BLF Pickup feature, which allows your phone to display the caller ID when the specified monitored line receives an incoming call.

You can pick up the call to the monitored line, place a call to the monitored line, place a new call or go back to the Idle screen.

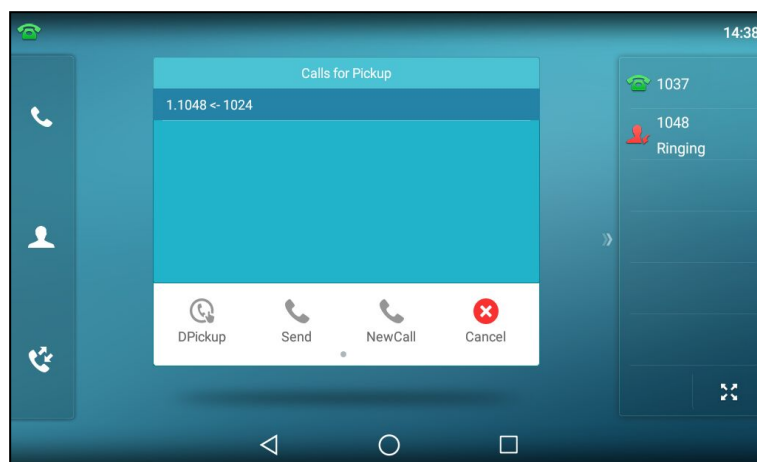

Picking up a Remote Call by BLF List Key

When a monitored line receives an incoming call, you can pick up the incoming call by tapping the BLF List key. For example, if the monitor user is not at his/her desk and someone rings his/her line, you can pick up the call simply by tapping the flashing BLF List key.

Before You Begin

Check with your system administrator to find out if this feature is available on your phone.

Procedure

1. Tap the BLF List key to pick up the call for the monitored line directly.

Transferring a Call by BLF List Key

When there is already an active call on the IP phones, you can transfer the active call to the monitored user by tapping the BLF List key.

The phone transfers (Blind Transfer or Attended Transfer) the active call differently depending on the Transfer Mode via Dsskey feature configured by your system administrator.

Topics

[Performing a Blind Transfer](#)

[Performing a Semi-attended/Attended Transfer](#)

Performing a Blind Transfer

Before You Begin

Check with your system administrator to make sure that the Transfer Mode via Dsskey is set to **Blind Transfer**.

Procedure

1. During a call, tap the BLF List key of the monitored line which you want to transfer this call to.

Performing a Semi-attended/Attended Transfer

Before You Begin

Check with your system administrator if the Transfer Mode via Dsskey is set to **Attended Transfer**.

Procedure

1. During a call, tap the BLF List key of the monitored line which you want to transfer this call to. The phone will dial out the number of the monitored line.
2. Tap the BLF List key of the monitored user again or **Transfer** to complete the transfer when the monitored user receives ringback or after the monitored user answers the call.

Retrieving a Call by a BLF List Key

You can use the BLF List key to retrieve a call which is parked to the monitored line.

Before You Begin

Check with your system administrator to find out if this feature is available on your phone.

Procedure

1. Tap the desired BLF List key to retrieve a call that is parked to the monitored line.

Barging In an Active Call by BLF List Key

You can use the BLF List key to barge in a conversation and set up a conference call.

Before You Begin

Check with your system administrator to find out if this feature is available on your phone.

Procedure

1. Tap the BLF List key.
The IP phone dials out the barge-in code followed by the monitored line, and then you can join the call. Each of the three parties can hear the other two parties.

Shared Line

Yealink IP phone supports using Shared Call Appearance (SCA) to share a line. So that this line can be registered on more than one IP phone at the same time.

Your system administrator can set your phone to use the shared line.

Note

Check with your system administrator to find out if SCA is available on your phone.

Topics

[State Indicator of Shared Line](#)

[Placing Calls on a Shared Line](#)

[Answering Calls on a Shared Line](#)

[Placing a Call on Public Hold](#)

[Placing a Call on Private Hold](#)

[Retrieving a Held Call Remotely on a Shared line](#)

[Barging In an Active Call on a Shared line](#)

[Pulling a Shared Call on a Shared line](#)

State Indicator of Shared Line

Your system administrator may assign multiple line keys to associate with a shared line, which enhances call visualization and simplifies call handling. Incoming calls to this shared line or outgoing calls from this shared line will be distributed evenly among the available line keys.

The shared line is indicated by different line key icons:

In the following figure, the first line key(shared line) is indicated by different line key icon:

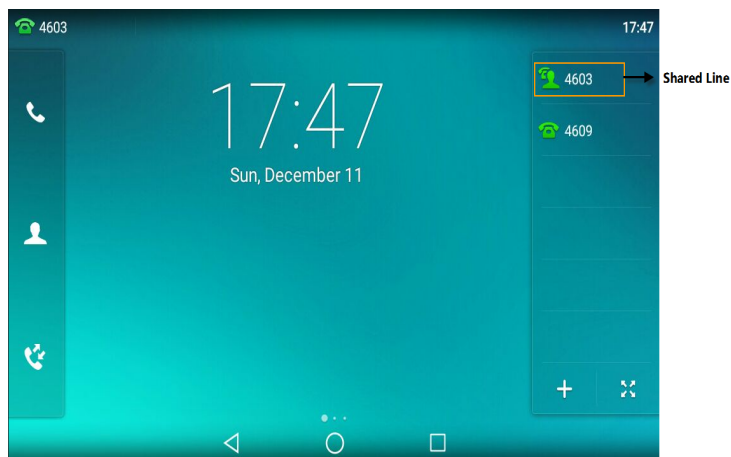

| Icon | Description |
|------|---|
| | The shared line is idle. |
| | The shared line is seized. |
| | The shared line receives an incoming call. |
| | The shared line is dialing. |
| | The shared line is busy or is in a call. |
| | The call on the shared line is placed on public hold. |
| | The call on the shared line is placed on private hold. |
| | |
| | The call on the shared line is barged in by the other shared line user. |
| | In a multi-party call, place the call on hold locally. |

Placing Calls on a Shared Line

You can have one or multiple calls on a shared line. The phone places a call on the first shared line key automatically. You can select the desired shared line key first and place a call using this key.

Related Topic

[Placing Calls](#)

Answering Calls on a Shared Line

When an incoming call arrives on the shared line, all the registered phones will ring simultaneously, and the call can be answered on any one of the phones. You can answer one or multiple calls on the shared line. Incoming calls will be distributed evenly among the available shared line keys.

Note

If the number of incoming calls is greater than the configured line keys, the line keys will be used by sequence circulation. Contact your system administrator for more information.

Related Topic

[Answering Calls](#)

Placing a Call on Public Hold

You can place a call on public hold that any shared line phone can retrieve the held call.

Procedure

1. During a call, press the HOLD key or tap the **Hold** soft key.
The call is held on your phone, and all of the phones registered with shared line show the call is in a held state.

Placing a Call on Private Hold

In SCA scenario, you can place a call on private hold that only you can retrieve the held call. You can hold a call privately on a shared line using the **PriHold** soft key preset by your system administrator. If the **PriHold** soft key is not available on your phone, you can also set a line key as private hold key manually.

Topics

[Setting a Private Hold Key](#)

[Holding a Call Privately](#)

Setting a Private Hold Key

Procedure

1. Swipe left or right to go to the second idle screen.
2. Navigate to **Settings**->**Features**->**Dsskey**.
3. Select the desired line key.
4. Select **Key Event** from the **Type** field.
5. Select **Private Hold** from the **Key Type** field.
6. (Optional.) Enter the string that will display on the phone screen in the **Label** field.
7. Tap  .

Tip

You can drag the line key to the **Edit** field to set a Private Hold key.

Holding a Call Privately

You can hold a call privately on a shared line using a **PriHold** soft key or Private Hold key.

Before You Begin

If the **PriHold** soft key is not available on your phone, you need to set a Private Hold key in advance.

Procedure

1. During a call, tap the **PriHold** soft key or private hold key on the phone when there is an active call on the shared line (You may need to swipe the soft key area left to see the **PriHold** soft key).
The call is held on your phone, and the other phones registered with shared line show the call is in the busy state on the shared line key. Other users on the shared line cannot resume your held call.

Related Topic

[Setting a Private Hold Key](#)

Retrieving a Held Call Remotely on a Shared line

If you place a call on hold on a shared line, you can resume this call at any time. When the shared line key shows a call that is in a held state, you can resume the held call remotely from other user's phone.

Before You Begin

There is at least one call placed on public hold on the shared line.

Procedure

1. Do one of the following:
 - Tap .
 - Long tap the desired line key.
The **Cancel**, **CallPull**, **NewCall** and **Retrieve** soft keys appear on the touch screen.
Tap **Retrieve** to retrieve the call.
Tap **Retrieve** to retrieve the call.

Barging In an Active Call on a Shared line

In SCA scenario, both you and other users can barge into an active call on the shared line. Only one user can barge into a call at a time. After a user barges into a call, the call turns into a three-party conference.

Before You Begin

There is at least one active call on the shared line.

Procedure

1. Long tap the desired line key.

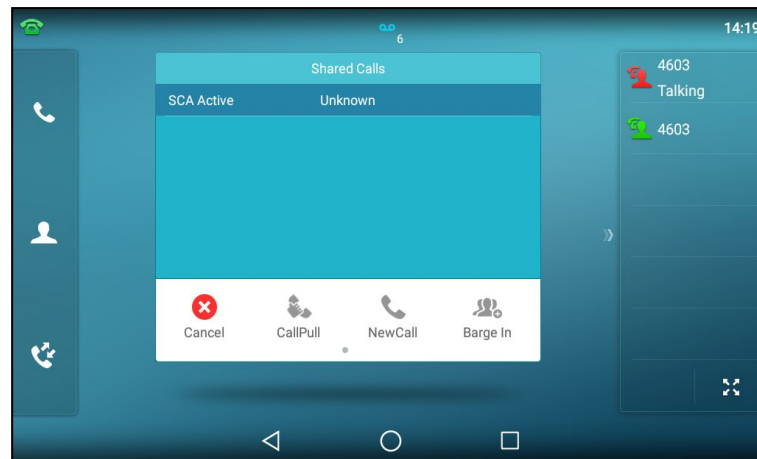

The **Cancel**, **CallPull**, **NewCall** and **Barge In** appear on the screen.

2. Tap **Barge In** to interrupt the active call.

Pulling a Shared Call on a Shared line

In SCA scenario, both you and other users can pull an existing call from another shared phone that is an active or hold state.

Check with your system administrator to find out if this feature is available for your phone.

Before You Begin

There is an active or held call on the shared line.

Procedure

2. Long tap the shared line key.

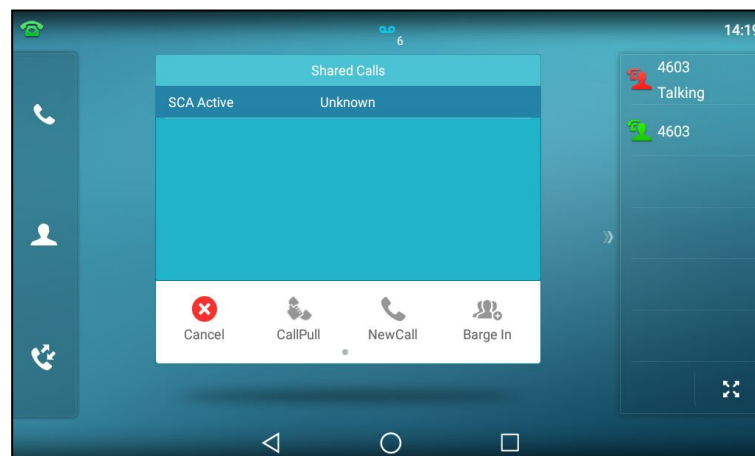

2. Tap **CallPull** to pull the call.

Intercom

Intercom is a useful feature in an office environment to quickly connect with the operator or the secretary. This enables you to place an intercom call that is answered automatically on the contact's phone as long as the contact is not in an active call.

Note

Intercom is not available on all servers. Contact your system administrator for more information.

Topics

[Placing an Intercom Call](#)

[Picking Up an Incoming Call of the Target Extension](#)

[Answering an Intercom Call](#)

Placing an Intercom Call

To use the intercom feature, you should set a line key as an Intercom key in advance.

Topics

[Setting an Intercom Key](#)

[Placing an Intercom Call to the Target Extension](#)

Setting an Intercom Key

Procedure

1. Swipe left or right to go to the second idle screen.
2. Navigate to **Settings**->**Features**->**Dsskey**.
3. Select the desired line key.
4. Select **Intercom** from the **Type** field.
5. Select the desired line from the **Account ID** field.
6. (Optional.) Enter the string that will display on the touch screen in the **Label** field.
7. Enter the phone number or the extension you want to monitor in the **Value** field.
8. Tap  .

Tip

You can drag the line key to the **Edit** field to set an Intercom key.

Placing an Intercom Call to the Target Extension

You can place an intercom call when the phone is idle or during a call. The target phone plays a warning tone and automatically answers the call in speakerphone (hands-free) mode by default.

When the target phone has an active call, the intercom call is answered automatically after the active call ends.

Before You Begin

You need to set an Intercom key in advance.

Procedure

1. Tap the intercom key.
2. To end the intercom call, tap the intercom key again or **End Call**.

Related Topic

[Setting an Intercom Key](#)

Picking Up an Incoming Call of the Target Extension

When a target extension receives an incoming call, you can pick up the incoming call by pressing the Intercom key. Check with your system administrator to find out if this feature is available on your phone.

Before picking up an incoming call, make sure that the directed call pickup code has been configured either for an Intercom key or for Call Pickup feature in advance.

Note

If the directed call pickup code is not set, the phone will place a call to the target extension instead of picking up an incoming call of the target extension when you tap the intercom key.

Topics

[Setting the Directed Call Pickup Code for Intercom Key](#)

[Picking Up a Remote Call by Intercom Key](#)

Setting the Directed Call Pickup Code for Intercom Key

The directed call pickup code can be configured for the intercom key.

Before You Begin

Get the directed call pickup code from your system administrator.

Procedure

1. Drag the intercom key to the **Edit** field.
2. Enter the directed call pickup code in the **Extension** field.
3. Tap .

Related Topic

[Setting an Intercom Key](#)

Picking Up a Remote Call by Intercom Key

When the target extension receives an incoming call, the intercom key icon of the target extension will change to .

Before You Begin

The directed pickup code has set for Call Pickup feature by your system administrator or you have assigned the directed pickup code for an Intercom key in advance.

Procedure

1. Tap the Intercom key to pick up the incoming call directly.

Related Topic

[Setting the Directed Call Pickup Code for Intercom Key](#)

Answering an Intercom Call

By default, when there is an incoming intercom call, the phone plays a warning tone and this incoming call will be answered automatically. You can configure the behavior when receiving an intercom call.

Topics

[Setting Intercom](#)

[Answering an Intercom Call](#)

Setting Intercom

You can configure the following behavior when receiving an intercom call.

Intercom Allow

Intercom Allow feature allows the IP phones to automatically answer an incoming intercom call. If you disable this feature, the phone will reject incoming intercom calls and send a busy message to the caller. Intercom Allow feature is enabled by default.

Note

Your system administrator can set a period of delay time before the phone automatically answers intercom calls.

Intercom Mute

Intercom Mute feature allows the IP phones to mute the microphone when incoming intercom calls are answered automatically. Intercom Mute is disabled by default.

Intercom Tone

Intercom Tone feature allows the IP phones to play a warning tone before answering an intercom call automatically. Intercom Tone is enabled by default.

Intercom Barge

Intercom Barge allows the IP phones to automatically answer an incoming intercom call while an active call is in progress. The active call will be placed on hold. If you disable this feature, the IP phone will handle an incoming intercom call like a normal incoming call while there is already an active call on the IP phone. Intercom Barge is disabled by default.

Note

To enable the phone to receive a new incoming call when it already has an active call, make sure that the call waiting feature is enabled on the phone in advance.

Procedure

1. Swipe left or right to go to the second idle screen.
2. Navigate to **Settings->Features->Intercom**.
3. Make the desired changes.
4. Tap .

Related Topic

[Enabling Call Waiting](#)

Answering an Intercom Call

By default, the intercom call is automatically answered on your phone. During the intercom call, you can switch among the Speakerphone (hands-free), Handset and Handset modes.

If your phone is set to answer intercom calls with your microphone muted, you need to press the Mute key to unmute your microphone before responding to the call.

Related Topics

[Switching Among the Handset, Speakerphone and Headset Modes](#)
[Muting/Unmuting Audio](#)

Video/Voice Mail

Voice Mail feature allows you to leave voice mails for someone or listen to your voice mail messages on your IP phone. This feature is set up on the server side and not all servers support this feature.

For SIP-T58V/A smart media phone, voice Mail feature also allows you to send video mails to someone or listen to your voice mail messages on your IP phone. The usage of video mail is the same as that of voice mail, the following takes voice mail as an example.

Topics

[Setting the Voice Mail Code](#)
[Receiving a Voice Message](#)
[Leaving Voice Mails](#)
[Listening to Voice Mails](#)



Setting the Voice Mail Code

If you want to connect your phone to the message center, you need to set the voice mail code on your phone.

Before You Begin

Get the voice mail code from your system administrator.

Procedure

1. Swipe left or right to go to the second idle screen.
2. Tap  to launch **Message** application.
3. Tap **Set Voice Mail**.
4. Enter the voice mail code (for example, *4) in the desired account field.
5. Tap .

Receiving a Voice Message

When receiving a new voice mail, the phone plays a warning tone and the power LED indicator slowly flashes red. A message of "n New Voice Mail(s)" ("n" indicates the number of unread voice messages) is displayed on the phone screen.

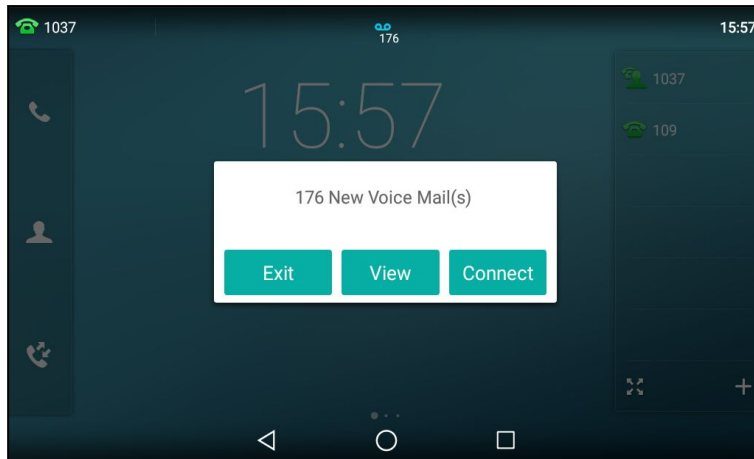

If the voice mail prompt box disappears, it will not pop up again unless the user receives a new voice mail or the user re-registers the account that has unread voice mail(s).

Note

Your system administrator can disable the prompt box for new message(s).

Leaving Voice Mails

You can leave a voice mail for other people when they are busy or inconvenient to answer the call. Follow the voice prompt from the system server to leave a voice mail, and then hang up.

Listening to Voice Mails

When the phone screen prompts that the phone receives a new voice mail, you can press the MESSAGE key or **Connect** to dial out the voice mail access code directly, or tap **Exit** to close the prompt box when you are not ready to listen to your voice mail.

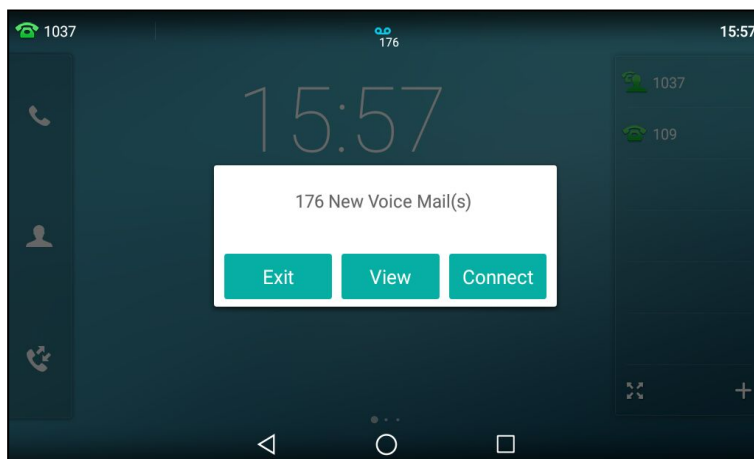

You can also listen to your voice mails after the voice mail pop-up message box disappears.

Before You Begin

You need to set the voice mail code in advance.

Procedure

1. Swipe left or right to go to the second idle screen.
2. Tap  to launch **Message** application.
3. Tap **View Voice Mail**.
The touch screen displays the amount of new and old voice mails.
You can tap the account to listen to voice mails.

Related Topic

[Setting the Voice Mail Code](#)

Hot Desking

Hot desking is regularly used in places where not all the employees are in the office at the same time, or not in the office for very long, which means that actual personal offices would be often vacant, consuming valuable space and resources.

You can use hot desking to log out from the current account and then log into a new account. As a result, many users can share one same phone resource at different times.

Note

Hot desking is not available on all servers. Contact your system administrator for more information.

Before You Begin

Your system administrator has set a Hot Desking key for you to use this feature. Get the login account information from your system administrator.

Procedure

1. Tap the hot desking key when the phone is idle.
The phone screen prompts you whether to clear the account configuration.
2. Tap **OK**.
Registration configurations of all accounts on the phone will be cleared immediately.
The login wizard will be displayed.
3. Enter the login information.
4. Tap  to log in.

Automatic Call Distribution (ACD)

ACD is often used in offices for customer service, such as call center. The ACD system handles large volumes of incoming calls from callers who have no need to talk to a specific person but who require assistance from any of multiple persons at the earliest opportunity. ACD on all IP phones allows the ACD system to distribute large volumes of incoming calls to the registered ACD users.

ACD is not available by default. Check with your system administrator to find out if this feature is available on your phone.

Topics

[Logging into the ACD System](#)

[Changing the ACD Status](#)

Logging into the ACD System

You can log into the ACD system. After logging in, you are ready to receive calls from the ACD system.

Before You Begin

Your system administrator has set an ACD key for you to log into the ACD system. Get the User ID and Password to access the ACD system from your system administrator.

Procedure

1. Tap the ACD key when the phone is idle.
The phone screen prompts you the following information:
User ID: the identity used to log into the queue.
Password: the password used to log into the queue.
2. Tap **Login** to log in.

Changing the ACD Status

You can tap the ACD key to show your current ACD user status.

When you set the ACD user status to be available, the ACD key icon indicator will become  , the server begins distributing calls to your IP phone.

When you set the ACD user status to be unavailable, the ACD key icon indicator will become  , the server temporarily stops distributing calls to your IP phone.

Procedure

1. Tap the **Available /Unavailable**.
ACD user status synchronizes on both the IP phone and ACD system.
2. To log out of the ACD system, tap the **Logout**.

System Applications

The system applications are pre-installed on your phone and they cannot be uninstalled. This chapter provides basic operating instructions for using the system applications.

Topics

[Managing Applications and Widgets](#)

[Managing Running Applications](#)

[APP Accounts](#)

[File Manager](#)

[Gallery](#)

[Recorder](#)

[Email](#)

[Browser](#)

[Calendar](#)

[Calculator](#)

[Clock](#)

Managing Applications and Widgets

You can add widgets to the idle screen for easy use, and adjust the location of applications and widgets. In order to save screen space and easy operation, you can integrate the same type of files into the same folder.

Topics

[Adding a Widget to the Idle Screen](#)

[Resizing a Widget](#)

[Moving an Application or Widget](#)

[Removing a Widget from the Idle Screen](#)

[Creating a Folder](#)

[Renaming a Folder](#)

Adding a Widget to the Idle Screen

The phone provides widgets like analog clock, calendar, digital clock, email and photo gallery. You can conveniently add these widgets to the idle screen as preferred.

Before You Begin

If you want to add an email widget, and you have not registered an account on the **Email** or **Calendar** application, a wizard will be provided for you to set up the email account according to the setup wizard. If you want to add a photo widget, you need to choose the images to display. You can not add this widget if there are no images in the image gallery.

Procedure

1. Long tap the empty spot on the idle screen.
2. Tap **WIDGETS**.
3. Touch and hold to pick up a widget.
4. Drag the desired widget up/down/left/right to the destination spot on the idle screen.

Related Topic

Adding APP Accounts

Resizing a Widget

Certain widgets such as calendar, digital clock and email can be resized on the idle screen.

Procedure

1. Long tap the desired widget for about 2 seconds, and then lift your finger from the screen.

This will bring up the white frame as shown below:

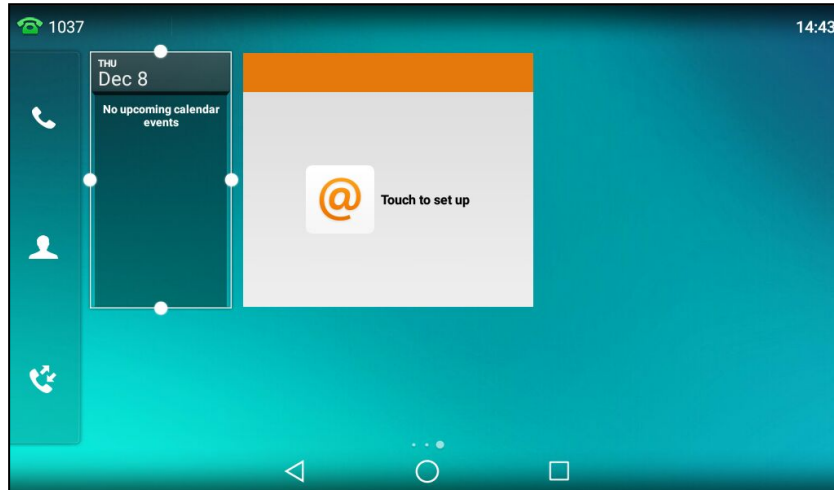

2. Drag the border of the frame to adjust the size.

Moving an Application or Widget

You can move an application or widget to a different spot on the idle screen or to a different idle screen.

Before You Begin

Before moving an application or widget, you should know the following:

- You can drag an application or widget to the rightmost of three idle screens to add an idle screen.
- If there is only one application or widget on the screen, you cannot drag the application or widget to the rightmost of three idle screens to add an idle screen.
- The idle screen (except the home screen) will be deleted automatically if there is no application or widget on the screen.

Procedure

1. Long tap the desired item for about 2 seconds.
2. Drag the item up/down/left/right to the destination spot on the screen.

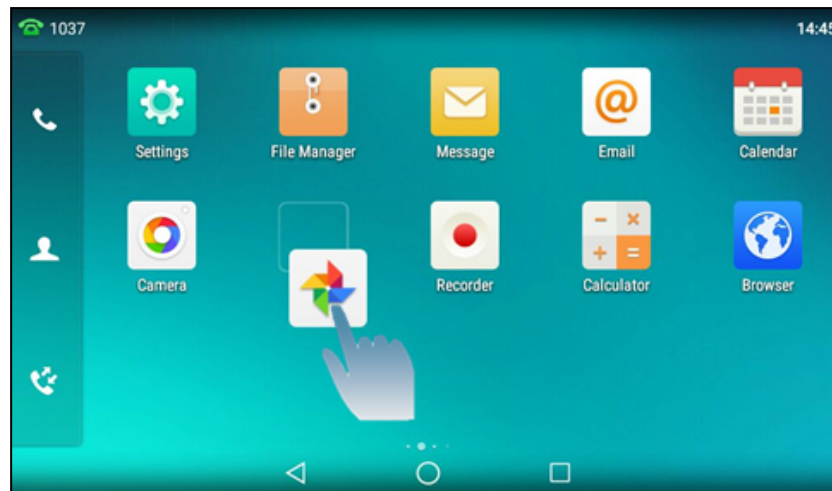

Removing a Widget from the Idle Screen

Removing operation only removes the widget of the application on the screen. The application itself will not be uninstalled.

Procedure

1. Long tap the desired item for about 2 seconds.

The **Remove** field will appear on the top of the touch screen.

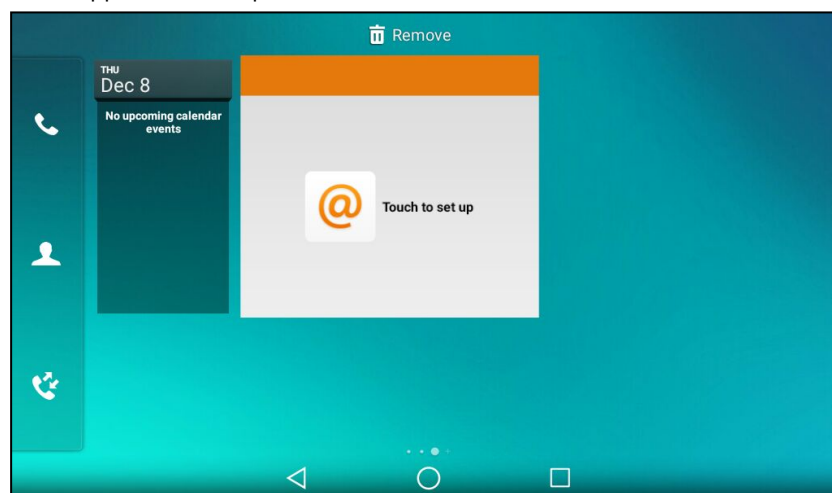

2. Drag the item to the **Remove** field to remove it.

Creating a Folder

You can create a folder to organize your applications. For example, you can place the same kind of applications in a folder.

Procedure

1. Drag an application icon over another application icon.

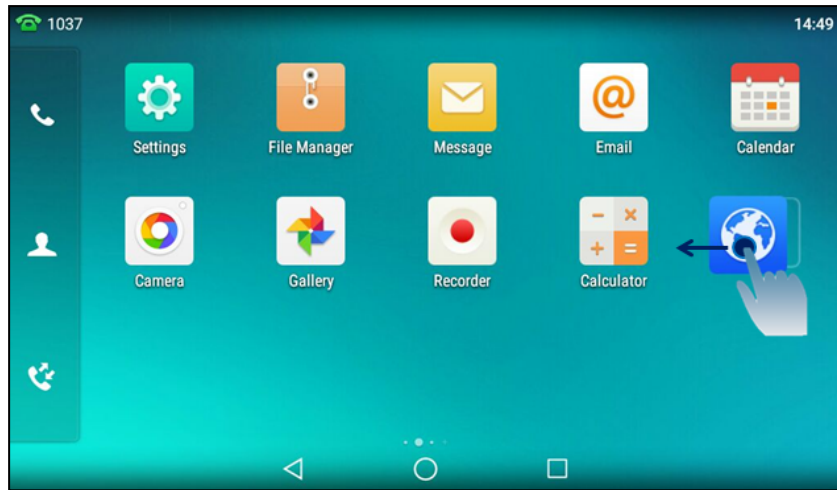

2. Lift your finger when a folder frame appears around the applications.

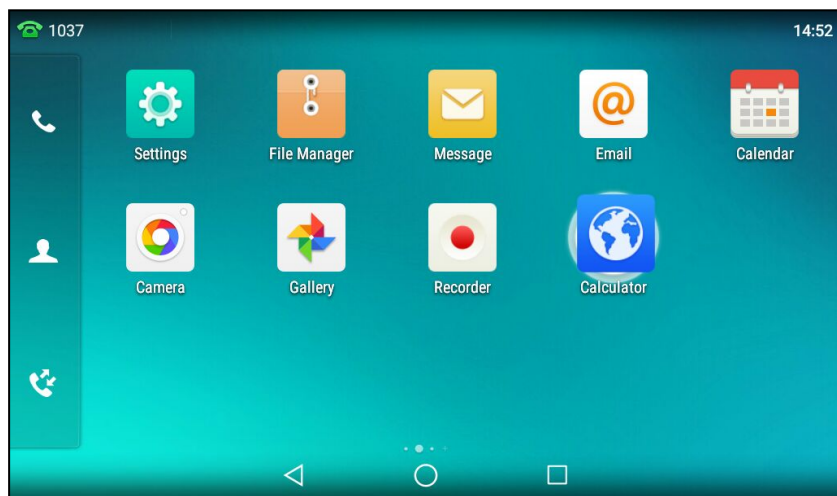

A new folder containing the selected applications is automatically created.

The folder will be deleted automatically if there is only one application in the folder.

Renaming a Folder

Procedure

1. Tap the desired folder to expand the folder.

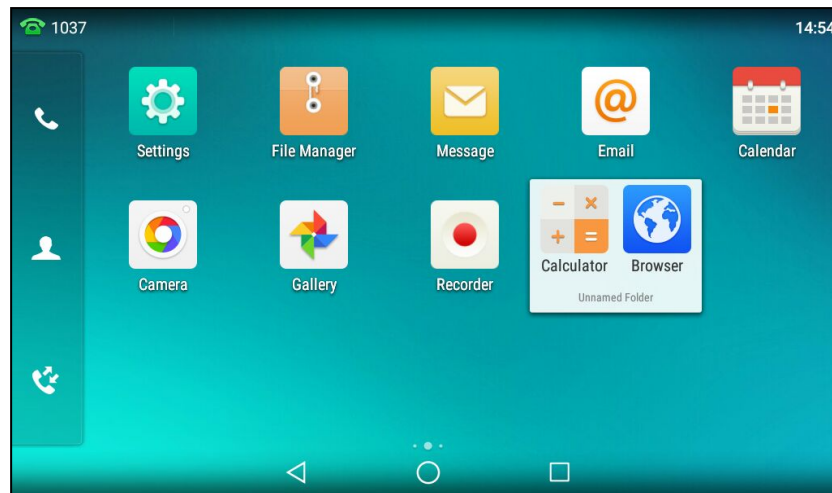

2. Tap the **Unnamed Folder** field.
3. Enter the desired folder name.
4. Tap **Done** on the onscreen keyboard.
5. Tap the blank area of the touch screen.
The folder name is renamed.

Managing Running Applications

Procedure

You can tap  to view and manage the list of recently used applications that are still running in the background.

You can do the following:

- Swipe the desired application left or right to stop the running application.
- Tap  to stop all running applications.
- Tap the desired application to access the application.

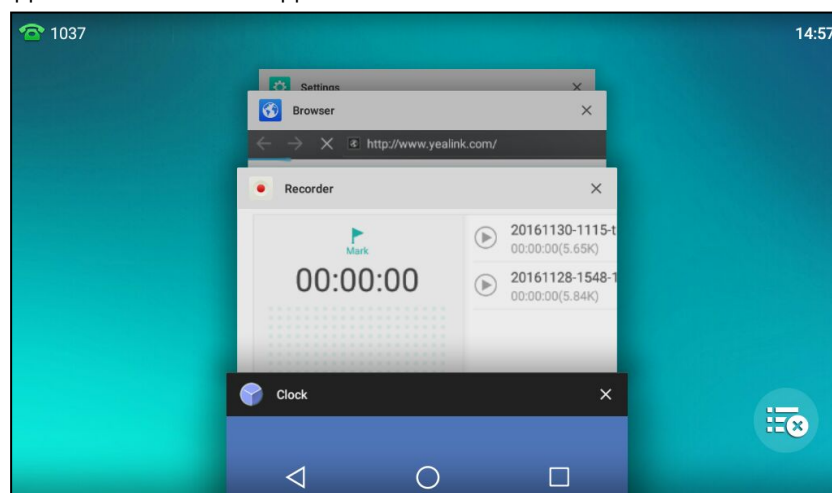

If there are no running applications, the touch screen will prompt "Your recent screens appear here".

APP Accounts

Email and **Calendar** applications require a registered account. You can create accounts to have the best experience with your phone. You can also sync the account information or remove the account.

If you want to sync contacts from Google, you need to register a Google account first.

Topics

[Adding APP Accounts](#)

[Syncing APP Account Information](#)

[Removing APP Accounts](#)

Adding APP Accounts

You can add Exchange, personal(IMAP), or Google accounts for your **Email** and **Calendar** applications. The Google account can be also used to sync the Google contacts.

Note

If you cannot add a Google account, contact your system administrator for help installing the GMS core package on your phone.

The following is an example of adding a personal(IMAP) account.

Procedure

1. Swipe down from the top of the screen or swipe left/right to go to the second idle screen.
2. Navigate to **Settings**->**Basic Settings**->**APP Accounts**.
3. Tap **Add account**.
4. Select **Personal (IMAP)**.
5. Enter the email address.
6. Tap **Next** or **Manual setup**.
7. Select the email account type.
 - **POP3**: When using POP3, all emails are stored locally instead of the server side. Please check with your network administrators for the correct email account settings for POP3.
 - **IMAP**: When using IMAP, all emails are stored on the server side and users can see them from the IP phone or other mail clients as well. Please check with your network administrators for the correct email account settings for IMAP.
 - **Exchange**: When using Exchange, all emails are stored in the central Exchange mail server and can be checked using a capable mail client such as Microsoft Outlook. Please check with your network administrators for the correct email account settings for Exchange.
8. Enter the password, and then tap **NEXT**.
9. Configure the incoming server settings, and then tap **Next**.
10. Configure the outgoing server settings, and then tap **Next**.
11. Configure the account options, and then tap **Next**.
12. Enter the string in the **Your name** field as the sender name, and then tap **Next**.

You are able to start using the email account now.

Syncing APP Account Information

Procedure

1. Swipe down from the top of the screen or swipe left/right to go to the second idle screen.
2. Navigate to **Settings->Basic Settings->APP accounts.**
3. Tap the desired account type.
4. Do one of the following:

- If you want to sync all accounts, tap  ->**Sync now.**

In the following example, it will sync both ll506466499@sina.com and ll506466400@sina.com information.

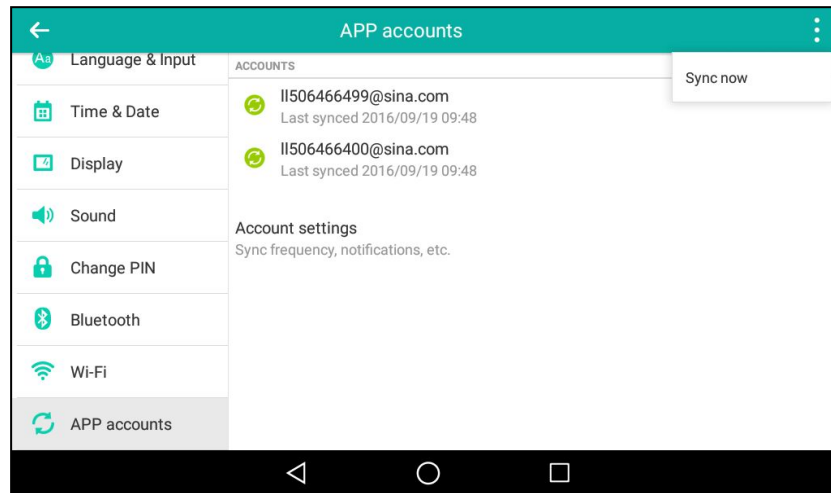

- If you want to sync a single account, select the desired account.

Tap  ->**Sync now.**

In the following example, it will only sync ll506466499@sina.com information.

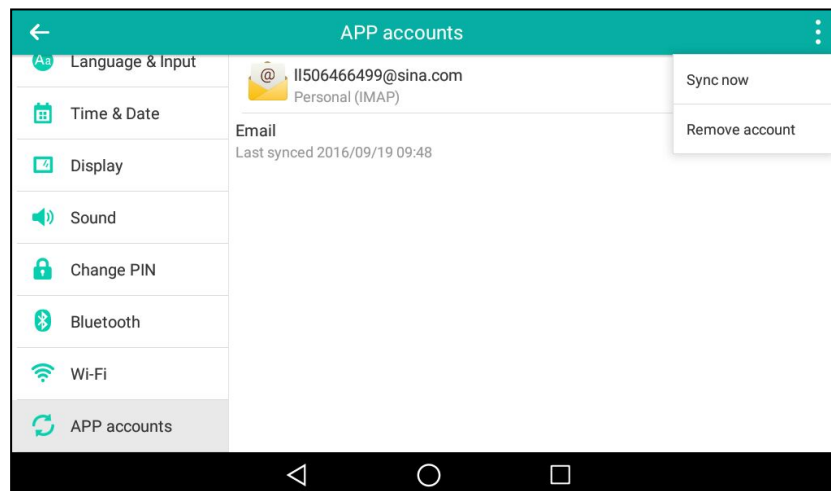

Removing APP Accounts

Procedure

1. Swipe down from the top of the screen or swipe left/right to go to the second idle screen.
2. Navigate to **Settings->Basic Settings->APP accounts.**
3. Tap the desired account type.
4. Select the desired account.
5. Tap  ->**Remove account.**

The phone screen prompts you whether to remove the account.

6. Tap **Remove account**.

File Manager

File Manager is a tool that allows you to view, search, delete, copy or move photo/video/audio files. You can also share files via Bluetooth or email. It helps you to access and manage files in the internal SD card as well as USB flash drive.

Topics

[Viewing Files](#)

[Searching Files](#)

[Copying Files](#)

[Cutting Files \(Moving Files\)](#)

[Deleting Files](#)

[Sharing Pictures/Videos/Audios via Bluetooth](#)

[Sharing Pictures/Videos/Audios via Email](#)

Viewing Files

Procedure

1. Swipe left or right to go to the second idle screen.
2. Tap  to launch **File Manager** application.
3. Tap **Photos/Videos/Audios** in the **Local Storage** field.
If a USB flash drive has been connected to your phone, you can tap **Photos/Videos/Audios** in the **USB Storage** field to view the pictures stored in USB flash drive.
4. Tap the desired picture/video/audio to view.

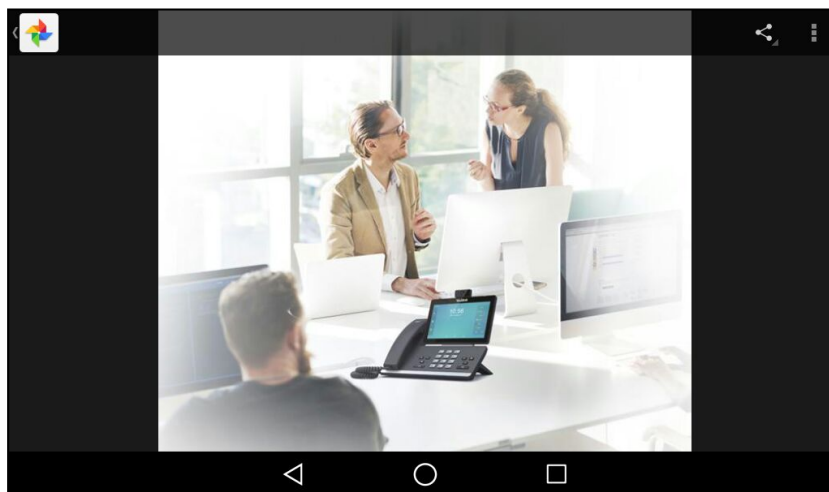

You can also swipe down from the top of the screen to enter the control center, and then tap **USB** to launch **File Manager** application to view the files if you have connected a USB flash drive to the phone.

Tip

The menu keys and Android keys will disappear within 5 seconds, you may tap the touch screen to show them again.

Related Topics



[Setting a Picture as Wallpaper](#)

[Printing Pictures](#)

[Viewing Detail Information of the Pictures/Videos](#)

Searching Files

Procedure



1. Swipe left or right to go to the second idle screen.
2. Tap  to launch **File Manager** application.
3. Tap  on the top-right of the screen.
4. Enter one or more continuous characters of the file name.

The touch screen shows the file whose name matches the entered characters. You can drag up and down to scroll through the searching results, and then tap the desired result to view the file.

Copying Files

You can copy the files that stored in the USB flash drive to internal SD card, or copy the files that stored in internal SD card to the USB flash drive.

Procedure

1. Swipe left or right to go to the second idle screen.
2. Tap  to launch **File Manager** application.
3. Tap **Photos/Videos/Audios** in **Local Storage** field.
If a USB flash drive has been connected to your phone, you can tap **Photos/Videos/Audios** in the **USB Storage** field to view the files stored in USB flash drive.
The right of the touch screen shows all pictures/videos/audios.
4. Check the checkbox(es) before the desired file(s).
You can also check the **Select All** checkbox to copy all files.
5. Tap .

The following prompt will appear on the touch screen of the phone:

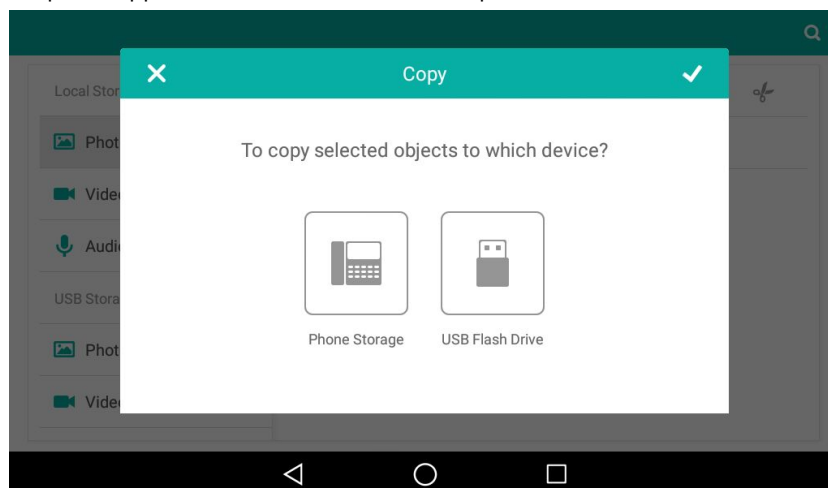

6. Tap the desired storage device.
7. Tap .

The files are copied successfully with a prompt.

Cutting Files (Moving Files)

Once you move the files, the file will not be kept in the source storage device.

Procedure

1. Swipe left or right to go to the second idle screen.
2. Tap  to launch **File Manager** application.
3. Tap **Photos/Videos/Audios** in **Local Storage** field.
If a USB flash drive has been connected to your phone, you can tap **Photos/Videos/Audios** in the **USB Storage** field to view the files stored in USB flash drive.
The right of the touch screen shows all pictures/videos/audios.
4. Check the checkbox(es) before the desired file(s).
You can also check the **Select All** checkbox to cut all files.

5. Tap  .

The following prompt will appear on the touch screen of the phone:

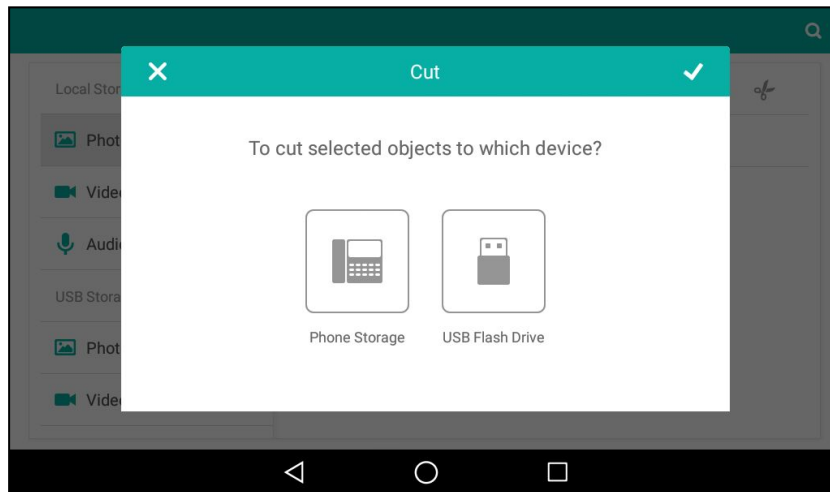

6. Tap the destination storage device.
7. Tap  .

The files are cut successfully with a prompt.

Deleting Files

Procedure

1. Swipe left or right to go to the second idle screen.
2. Tap  to launch **File Manager** application.
3. Tap **Photos/Videos/Audios** in **Local Storage** field.
If a USB flash drive has been connected to your phone, you can tap **Photos/Videos/Audios** in the **USB Storage** field to view the files stored in USB flash drive.
The right of the touch screen shows all pictures/videos/audios.
4. Check the checkbox(es) before the desired file(s).
You can also check the **Select All** checkbox to delete all files.

5. Tap  .

The phone screen prompts you whether to delete the files.



6. Tap **OK**.

Sharing Pictures/Videos/Audios via Bluetooth

Before You Begin

Before sharing pictures/videos via Bluetooth, make sure the Bluetooth device is discoverable.

Procedure

1. Swipe left or right to go to the second idle screen.
2. Tap  to launch **File Manager** application.
3. Tap **Photos/Videos/Audios** in **Local Storage** field.
If a USB flash drive has been connected to your phone, you can tap **Photos/Videos/Audios** in the **USB Storage** field to view the files stored in USB flash drive.
The right of the touch screen shows all pictures/videos/audios.
4. Check the checkbox(es) before the desired file(s).
5. Tap  .
6. Tap **Bluetooth**, and then select **Always** or **Just once**.
7. If the Bluetooth is deactivated, it will prompt you to tap **Turn on** to activate the Bluetooth mode.
The IP phone scans and displays the available Bluetooth device automatically.
If there is no Bluetooth device found on the touch screen, navigate to  -> **Refresh** to search for the Bluetooth devices.
8. Tap the desired Bluetooth device to share the pictures/videos/audios.
The touch screen will prompt "Sending n file to "XXX"" (n represents the number of the files that are being sent).
9. Accept the Bluetooth file transfer request on the Bluetooth device.

If the pictures are successfully transferred, the notification center will display a notification "Bluetooth share: Sent files n successful, n unsuccessful." (n represents the number of files that are sent successfully or unsuccessfully).

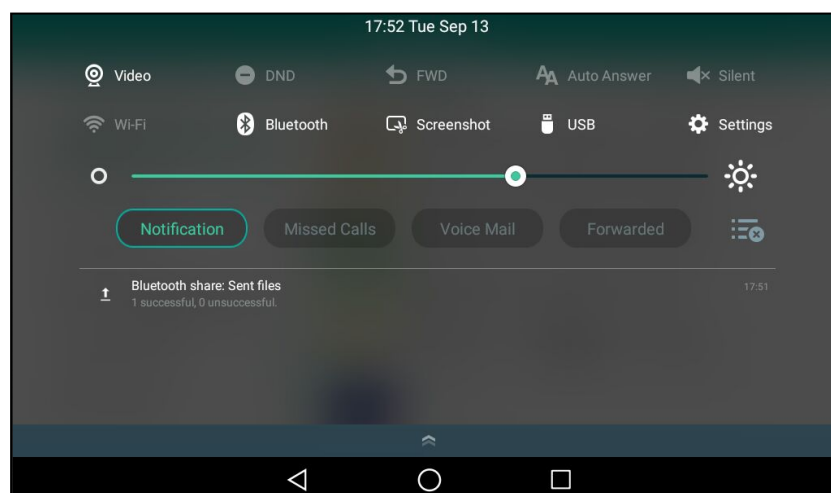



You can tap the notification to view the detail information about the shared files.

Sharing Pictures/Videos/Audios via Email

Before You Begin

Make sure you have signed in an email account.

Procedure

1. Swipe left or right to go to the second idle screen.
2. Tap  to launch **File Manager** application.
3. Tap **Photos/Videos/Audios** in **Local Storage** field.
If a USB flash drive has been connected to your phone, you can tap **Photos/Videos/Audios** in the **USB Storage** field to view the files stored in USB flash drive.
4. Check the checkbox(es) before the desired file(s).
5. Tap .
6. Tap **Email**, and then select **Always** or **Just once**.
7. Compose the Email.
8. Enter the email account you want to send the email to in the **To** field.
9. (Optional.) Enter the email subject in the **Subject** field.

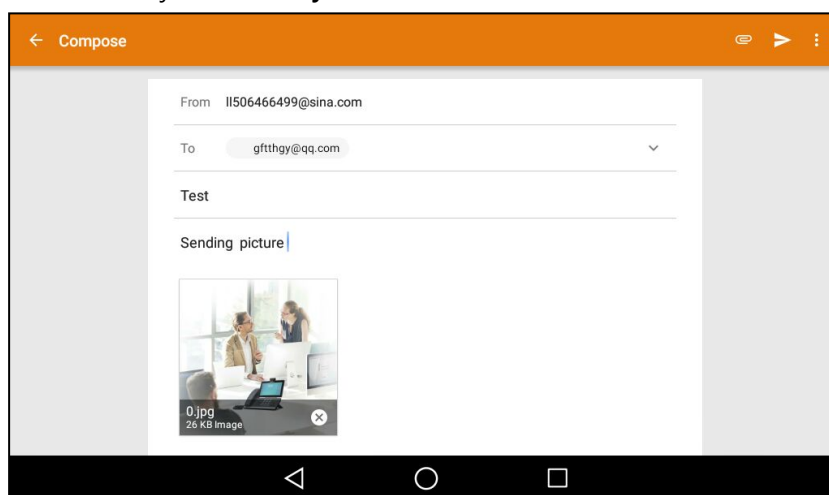

10. Tap  to send the email.

The pictures/videos/audios are transferred as a mail attachment. The attachment files size must be within 5MB.

Related Topic

[Signing In Email](#)

Gallery

You can use the **Gallery** application to view pictures/videos stored in internal SD card/USB flash drive or take pictures/videos (only for T58A). You can also perform basic editing tasks on pictures or set the desired picture as the wall-paper. The pictures/videos can be shared with friends via Bluetooth or email.

Topics

[Viewing Pictures/Videos](#)

[Editing Pictures](#)
[Rotating Pictures](#)
[Adding a Filter for Pictures](#)
[Adding a Frame for Pictures](#)
[Cropping Pictures](#)
[Coloring Pictures](#)
[Setting a Picture as Wallpaper](#)
[Printing Pictures](#)
[Viewing Detail Information of the Pictures/Videos](#)
[Deleting Pictures/Videos](#)
[Taking a Picture/Video \(Only for T58V/A\)](#)
[Sharing Pictures/Videos via Bluetooth](#)
[Sharing Pictures/Videos via Email](#)



Viewing Pictures/Videos

Procedure

1. Swipe left or right to go to the second idle screen.
2. Tap  to launch the **Gallery** application.

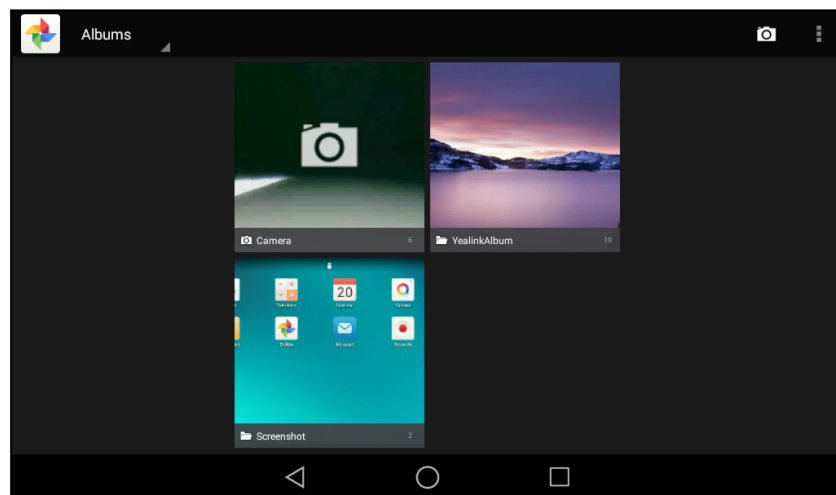
By default, the pictures/videos are displayed as thumbnails in an albums arrangement mode.





3. (Optional.) Tap **Albums**.
You can tap **Albums/Locations/Times/People/Tags** to view the pictures/videos in different arrangement modes.
4. Swipe left/right to view all albums if required.
5. Select the desired album.
6. You can do the following:
 - Tap the album name on top-left of the touch screen.
Select **Filmstrip view** or **Grid view** to view the pictures/videos in different modes.
 - Tap , and then tap **Group by**.
Select a desired group type in the pop-up dialog box to view the pictures/videos in different arrangement modes.
7. Tap a desired picture/video to preview the picture/video.
8. For picture albums, you can tap  -> **Slideshow** to start a slide show of the pictures in the album.

Tip

The menu keys and Android keys will disappear within 5 seconds, you may tap the touch screen to show them again.

Editing Pictures

Procedure

1. Swipe left or right to go to the second idle screen.
2. Tap  to launch the **Gallery** application.
3. Tap the desired picture.
4. Tap .
5. You can do the following:
 - Tap **Rotate left/Rotate right** to rotate the picture left/right.
 - Tap **Crop** to resize the picture.
 - Tap **Edit** to add filters/add a picture frame/crop the picture/adjust the exposure, contrast, saturation, etc.
6. Tap **SAVE**.

Note

The menu keys and Android keys will disappear within 5 seconds, you may tap the touch screen to show them again.

Related Topics

[Adding a Filter for Pictures](#)



[Adding a Frame for Pictures](#)

[Cropping Pictures](#)

[Coloring Pictures](#)

Rotating Pictures



Procedure

1. Swipe left or right to go to the second idle screen.
2. Tap  to launch the **Gallery** application.
3. Tap the desired picture album.
4. Tap the desired picture.
5. Tap  -> **Rotate left/Rotate right** to rotate the picture left/right
6. Tap **SAVE**.

Adding a Filter for Pictures



Procedure

1. Swipe left or right to go to the second idle screen.
2. Tap  to launch the **Gallery** application.
3. Tap the desired picture album.
4. Tap the desired picture.

5. Navigate to  -> **Edit**->  .
6. Select the desired filter.
7. Tap **SAVE**.



Adding a Frame for Pictures

Procedure

1. Swipe left or right to go to the second idle screen.
2. Tap  to launch the **Gallery** application.
3. Tap the desired picture album.
4. Tap the desired picture.
5. Navigate to  -> **Edit**->  .
6. Select the desired frame.
7. Tap **SAVE**.



Cropping Pictures

Procedure

1. Swipe left or right to go to the second idle screen.
2. Tap  to launch the **Gallery** application.
3. Tap the desired picture album.
4. Tap the desired picture.
5. Navigate to  -> **Edit**->  .
6. You can do the following:
 - Tap **Crop** to resize the picture.
 - Tap **Straighten** to straighten the picture.
 - Tap **Rotate** to rotate the picture clockwise.
 - Tap **Mirror** to flip the picture symmetrically.
 - Tap **Draw** to draw the picture.
7. Tap **SAVE**.



Coloring Pictures

Procedure

1. Swipe left or right to go to the second idle screen.
2. Tap  to launch the **Gallery** application.
3. Tap the desired picture.
4. Navigate to  -> **Edit**->  .
5. Adjust the desired exposure, contrast, saturation and so on.
6. Tap **SAVE**.

Setting a Picture as Wallpaper

Procedure



1. Swipe left or right to go to the second idle screen.
2. Tap  to launch the **Gallery** application.
3. Tap the desired picture album.
4. Tap the desired picture.
5. Navigate to  -> **Set picture as**.
6. Do one of the following:
 - If you want to set the picture as phone wallpaper, tap **Set wallpaper** on the top-right of the screen.
 - If you connect EXP50 to your phone, tap **Exp Background**, and then tap **Set as exp background** to set the picture as EXP wallpaper.

Printing Pictures

Before You Begin



Before printing the picture, make sure your phone has connected to the network printer. For more information, refer to the documentation from the printer manufacturer.

Procedure

1. Swipe left or right to go to the second idle screen.
2. Tap  to launch the **Gallery** application.
3. Tap the desired picture album.
4. Tap the desired picture.
5. Navigate to  -> **Print** to print the picture.



Viewing Detail Information of the Pictures/Videos

Procedure

1. Swipe left or right to go to the second idle screen.
2. Tap  to launch the **Gallery** application.
3. Tap the desired album.
4. Tap the desired picture/video.
5. Navigate to  -> **Details** to view the detail information of the picture/video.

Deleting Pictures/Videos

Procedure

1. Swipe left or right to go to the second idle screen.
2. Tap  to launch the **Gallery** application.
3. Tap the desired album.
4. Do one of the following:
 - Long tap one of the pictures/videos.
 - Navigate to  -> **Select item**.
Select the pictures/videos you want to delete.

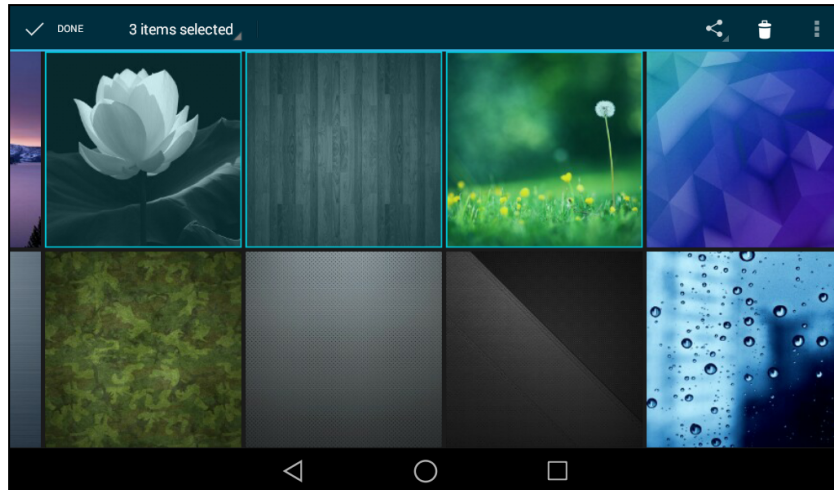

You can also tap **n items selected** (n represents the number of pictures you selected) and then tap **Select all** to select all pictures.







5. Tap  to delete the selected pictures/videos.
The phone screen prompts you whether to delete the pictures.
6. Tap **OK**.

Taking a Picture/Video (Only for T58V/A)

Before You Begin

Make sure you have inserted the camera to the phone.

Procedure

1. Swipe left or right to go to the second idle screen.
2. Tap  to launch the **Gallery** application.
3. Tap  on the top-right.
4. (Optional.) Tap , and then do the following:
 - Tap  to turn on the camera grid.
 - Tap  to configure the camera timer.
5. Swipe right, and then select **Camera** or **Video**
6. Tap  to take a picture or tap  to take video.

Sharing Pictures/Videos via Bluetooth

Before You Begin

Before sharing pictures/videos via Bluetooth, make sure the Bluetooth device is discoverable.



Procedure

1. Swipe left or right to go to the second idle screen.
2. Tap  to launch the **Gallery** application.

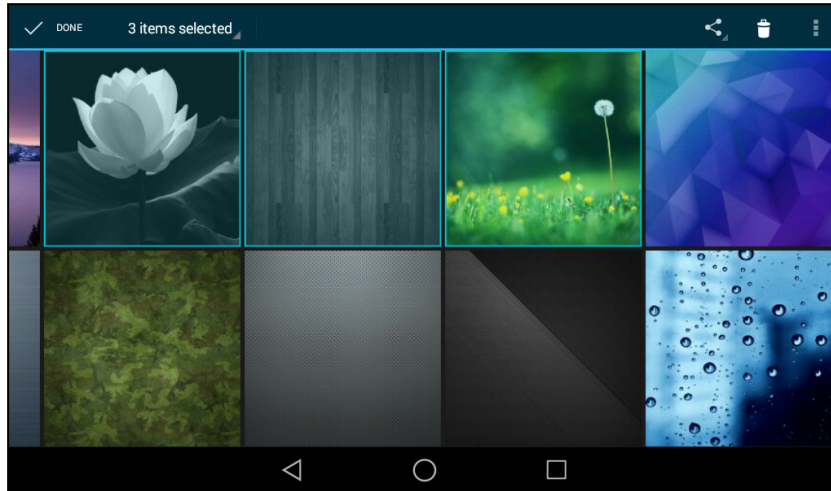
3. Tap the desired picture album.
4. Do one of the following:
 - Long tap one of the pictures/videos.
 - Tap  -> **Select item**.
Select the pictures/videos you want to share.



You can also tap **n items selected** (n represents the number of pictures you selected) and then tap **Select all** to select all pictures.

5. Tap , and then select **Bluetooth**.
 6. If the Bluetooth is deactivated, it will prompt you to tap **Turn on** to activate the Bluetooth mode.
The IP phone scans and displays the available Bluetooth device automatically.
If there is no Bluetooth device found on the touch screen, navigate to  -> **Refresh** to search for the Bluetooth devices.
 7. Tap the desired Bluetooth device to share the pictures/videos.
The touch screen will prompt "Sending n file to "XXX"" (n represents the number of pictures/videos that are being sent).
 8. Accept the Bluetooth file transfer request on the Bluetooth device.
- If the pictures/videos are successfully transferred, the notification center will display a notification "Bluetooth share: Sent files: Sent files n successful, n unsuccessful." (n represents the number of files that are sent successfully or unsuccessfully).

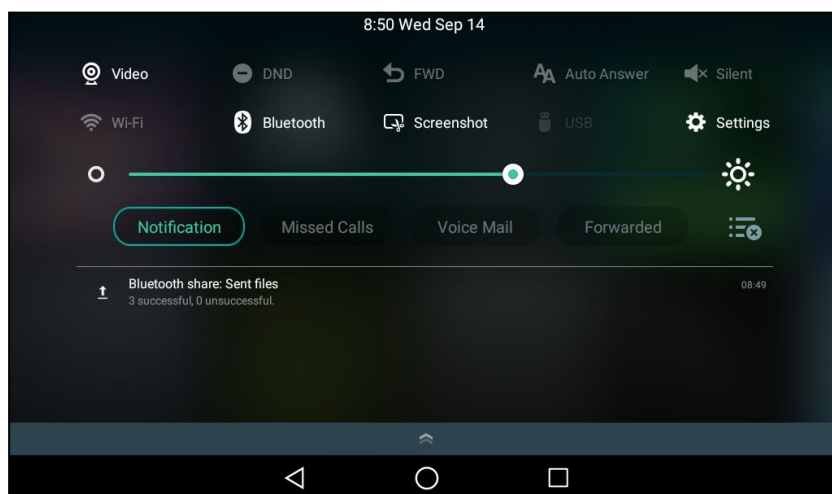



You can tap the notification to view the detail information about the shared files.

Sharing Pictures/Videos via Email

Before You Begin

Make sure you have signed in an email account.

Procedure

1. Swipe left or right to go to the second idle screen.
2. Tap  to launch the **Gallery** application.
3. Tap the desired album.
4. Do one of the following:
 - Long tap one of the pictures/videos.
 - Tap  and then tap **Select item**.
Select the pictures/videos you want to share.

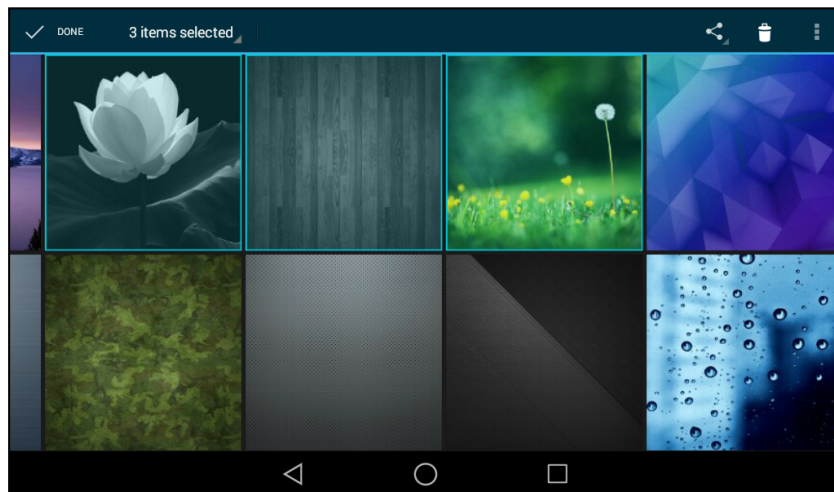

You can also tap **n items selected** (n represents the number of pictures you selected) and then tap **Select all** to select all pictures.

5. Tap  and then select **Email**.
6. Compose the Email.
7. Enter the email account you want to send the email to in the **To** field.
8. (Optional.) Enter the email subject in the **Subject** field.

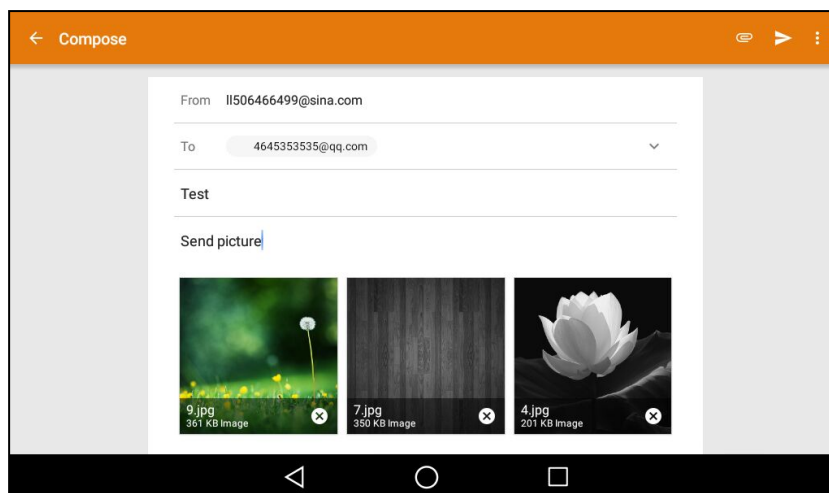

9. Tap  to send the email.

The pictures/videos are transferred as a mail attachment. The attachment files size must be within 5MB.

Related Topic

[Signing In Email](#)

Recorder

You can use the **Recorder** application to record audios and manage the recorded audios.

During recording, you can mark specific moments so that you can quickly find and listen to them later. You can record up to 12 hours in one file. The recorded audios are saved in *.amr format with the name consisting of a prefix "record@" and date & time stamp.

Topics

[Recording Audios](#)

[Playing the Recorded Audios](#)

[Pause/Resuming a Playback](#)

[Fast Forwarding/Rewinding a Playback](#)

[Stopping a Playback](#)

[Renaming the Recorded Audios](#)

[Deleting a Recorded File](#)

[Deleting All Recorded Audios](#)

[Checking Storage Space](#)





Recording Audios

By default, the recorded audios are saved in the internal SD card. You can connect a USB flash drive to your phone, the recorded audios will be saved in the USB flash drive instead of the internal SD card.

Note

For more information on how to attach a USB flash drive, please refer to the Quick Start Guide for your IP phone on your phone's support page on [Yealink Support](#).

Procedure

1. Swipe left or right to go to the second idle screen.
 2. Tap  to launch the **Recorder** application.
 3. Tap  to start recording.
 4. You can do one of the following:
 - Tap  to pause the recording.
 - Tap  to set a mark.
The icon changes to , the number will increase if you set more marks.

And there is a red flag on this moment when playing the recorded audio.
 5. Tap  to end the recording and save the recorded audio.
- The recorded audio will be displayed on the right list automatically.

Playing the Recorded Audios



You can browse and play back the recorded audio files on your phone. The recorded audios are saved with the name consisting of a prefix "record@" and date & time stamp, for example, record@20170517-092310 was created on May 17, 2017, at 09:23:10.

When you receive an incoming call while playing a recording, the recording is paused automatically. If you reject the incoming call or end the handling call, the recording will continue to play automatically.

Tip

You can also play back the recorded audios on the phone or on a computer using an application capable of playing ".amr" files.



Procedure

1. Swipe left or right to go to the second idle screen.
2. Tap  to launch the **Recorder** application.
The touch screen shows all recorded files in the **Audio Recorder** list.
3. Tap  before the desired recorded audio to play the recorded audio.
The length of the recording and a progress bar are displayed as the recording plays.

Pause/Resuming a Playback

When you receive an incoming call while playing a recording, the recording is paused automatically. You can resume the playback after handling the call. You can also pause the recording manually at any time.

Procedure

1. Tap  to pause playing the recording. The  appears on the touch screen.
2. Tap  to resume the playback.

Fast Forwarding/Rewinding a Playback

While a recorded audio or call plays, you can fast forward or rewind the playback at any time.

Procedure

1. Drag the slider to skip forward the playing or rewind the playing.

If you have set marks for the recorded audio, you can drag the slider to the position with a red flag to listen to the marked moments.



Stopping a Playback

Procedure

1. Tap  to stop the playing.

Renaming the Recorded Audios



Procedure

1. Swipe left or right to go to the second idle screen.
2. Tap  to launch **Recorder** application.
The touch screen shows all recorded files in the **Audio Recorder** list.
3. Tap  after the desired recorded audios.
4. Tap **Rename**.
5. Enter the desired file name.
6. Tap **OK**.

Deleting a Recorded File

You can delete local recordings or call recordings in **Recorder** application. The local recorded audios are named of a prefix "record@" and date & time stamp, while the call recordings are named of the date & time stamp.



Procedure

1. Swipe left or right to go to the second idle screen.
2. Tap  to launch the **Recorder** application.
The touch screen shows all recorded files in the **Audio Recorder** list.
3. Tap  after the desired recorded audio.
4. Tap **Delete**.
The phone screen prompts you whether to delete the audio.
5. Tap **OK**.

Deleting All Recorded Audios

You can delete all the recorded audios when you need additional space on your USB drive.

Procedure

1. Swipe left or right to go to the second idle screen.
2. Tap  to launch **Recorder** application.
The touch screen shows all recorded files in the **Audio Recorder** list.
3. Tap  on the top-right of the touch screen.
The phone screen prompts you whether to delete all the audio files.
4. Tap **OK**.

Checking Storage Space

You can check the storage space (e.g., total space, available space) of the IP phone or connected USB flash drive.

Procedure

1. Swipe left or right to go to the second idle screen.
2. Navigate to **Settings**->**Status**->**Storage**.

Camera

SIP-T58V/A phone supports taking pictures and recording videos via camera. Before using the camera, you should insert the camera CAM50 to the phone.

The pictures/videos taken by the camera are saved in *.jpg/*.mp4 format with the name consisting of a prefix "IMG/VID" and date & time stamp in the internal SD card. You can view the pictures/videos in the **File Manager**.

Topics

[Inserting the USB Camera\(CAM50\) to the T58V/A Phone](#)

[Taking Pictures](#)

[Recording Videos](#)

[Camera Settings](#)

Inserting the USB Camera(CAM50) to the T58V/A Phone

The following introduces how to insert the CAM50 to the SIP-T58V/A IP phone.

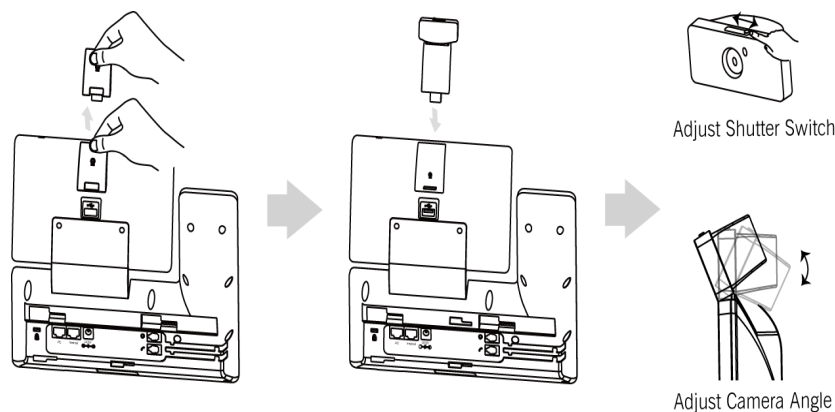

Note





The camera is connected to the USB port on the top of the phone. And the IP phone only supports the Yealink original USB camera CAM50. You should purchase it separately for SIP-T58A smart media phone.

Taking Pictures

Before You Begin

Make sure you have inserted the camera to the phone.

Procedure

1. Swipe left or right to go to the second idle screen.
2. Tap  to launch the **Camera** application.
3. (Optional.) Tap , and then do the following:
 - Tap  to turn on the camera grid.
 - Tap  to configure the camera timer.
4. Tap  to take a picture.





You can swipe left to view all pictures or videos taken by the camera.

Recording Videos

Before You Begin

Make sure you have inserted the camera to the phone.

Procedure

1. Swipe left or right to go to the second idle screen.
2. Tap  to launch the **Camera** application.
3. Swipe right, and then select **Video**.
4. (Optional.) Tap  ->  to turn on the camera grid.
5. Tap  to start recording.
The recording time will appear on the left-top of the touch screen.
6. Tap  to stop recording.



You can swipe left to view all videos or pictures taken by the camera.

Camera Settings

Before You Begin

Make sure you have inserted the camera to the phone.

Procedure

1. Swipe left or right to go to the second idle screen.
2. Tap  to launch the **Camera** application.
3. Swipe right, and then tap  on the right-top of the touch screen.
4. You can do the following:
 - Tap **Resolution & quality** to configure the resolution of the camera.
 - Tap **Advanced** to configure whether to use manual exposure.

Email

You can use the **Email** application to access personal or business email account, and send/receive emails. Before signing in email, you should configure the type of your email account.

Topics

[Signing In Email](#)

[Sending Emails](#)
[Reading Emails](#)
[Deleting Emails](#)
[Marking/Printing Email](#)
[Adding Multiple Email Accounts](#)
[Using Email Widget](#)
[Sending Files via Email](#)

Signing In Email

When launching the **Email** application for the first time, a wizard will be provided for you to set up the email account step by step.

Procedure





1. Do one of the following:
 - Swipe left or right to go to the second idle screen.
Tap  to launch **Email** application.
 - Swipe left or right to go to the third idle screen.
Tap the email widget.
2. Sign in email according to the setup wizard.

Related Topic

[Adding APP Accounts](#)

Sending Emails

Procedure

1. Swipe left or right to go to the second idle screen.
2. Tap  to launch **Email** application.
3. Tap .
4. Compose the email.
5. Enter the email account you want to send the email to in the **To** field.
6. (Optional.) Enter the email subject in the **Subject** field.
7. (Optional.) Tap  and then tap **Attach file** to add a file as a mail attachment.
8. Compose the email.
9. Enter the email account you want to send the email to in the **To** field.
10. (Optional.) Enter the email subject in the **Subject** field.
11. (Optional.) Tap  and then tap **Attach file** to add a file as a mail attachment.
The attachment file size must be within 5MB.
12. Tap  to send the email.

Reading Emails

If there is an incoming email, the IP phone will play a notification sound. And there is an incoming email notification on the notification center, you can tap the notification to read the email.

Procedure

1. Swipe left or right to go to the second idle screen.

2. Tap  to launch **Email** application.

If the email you want to read is not in the inbox, you can tap  on the top-left of the touch screen to select the folder that contains the email you want to read.

3. Tap the desired email to read.

Deleting Emails

Procedure

1. Swipe left or right to go to the second idle screen.

2. Tap  to launch **Email** application.

If the email you want to delete is not in the inbox, you can tap  on the top-left of the touch screen to select the folder that contains the email you want to delete.

3. Long tap the desired email.

4. Tap  to delete the email.

Marking/Printing Email



Procedure

1. Swipe left or right to go to the second idle screen.

2. Tap  to launch Email application.

If the email you want to configure is not in the inbox, you can tap  on the top-left of the touch screen to select the folder that contains the email you want to configure.

3. You can do the following:

- Tap  /  to mark the email as unread/read.

- Tap  -> **Print** to print the email.

- Long tap the desired email.

- Tap  -> **Add star** to star the email.

Adding Multiple Email Accounts

You can add more than one email account on the IP phone.

Procedure

1. Swipe left or right to go to the second idle screen.

2. Tap  to launch **Email** application.

3. Tap  on the top-left of the touch screen.

4. Navigate to **Settings**->**Add account**.

5. Add the account according to the setup wizard.

Once another email account is successfully added, the touch screen will display as below:

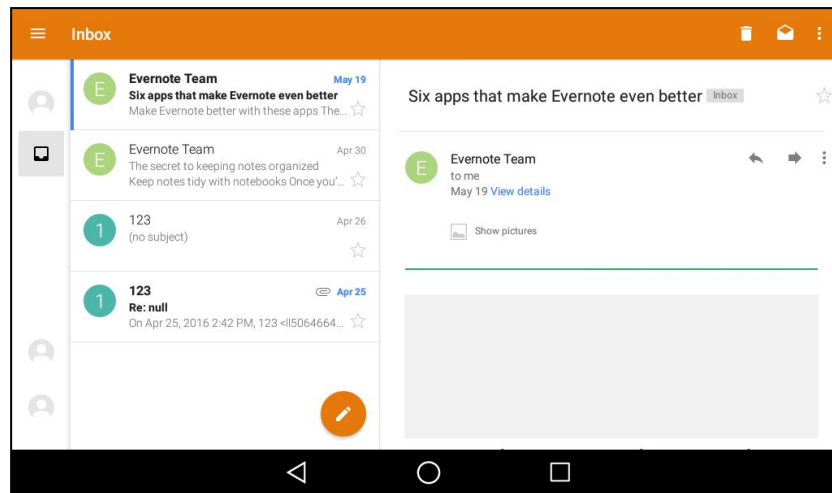

You can tap  on the bottom-left of the touch screen to switch between the email accounts.

Related Topic

[Adding APP Accounts](#)

Using Email Widget

After you sign in the email, you can choose the desired folder to display on the widget. If you add an email widget to display the unread emails, and you want the widget to display the incoming emails, you should add a new widget.

Procedure

1. Swipe left or right to go to the third idle screen.
2. Tap the email widget.
3. Tap the desired account, if you have more than one email account.
4. Tap the desired folder to display on the widget.
5. Tap the desired folder to display on the widget.

If you select **Inbox**, the email widget will display as below:

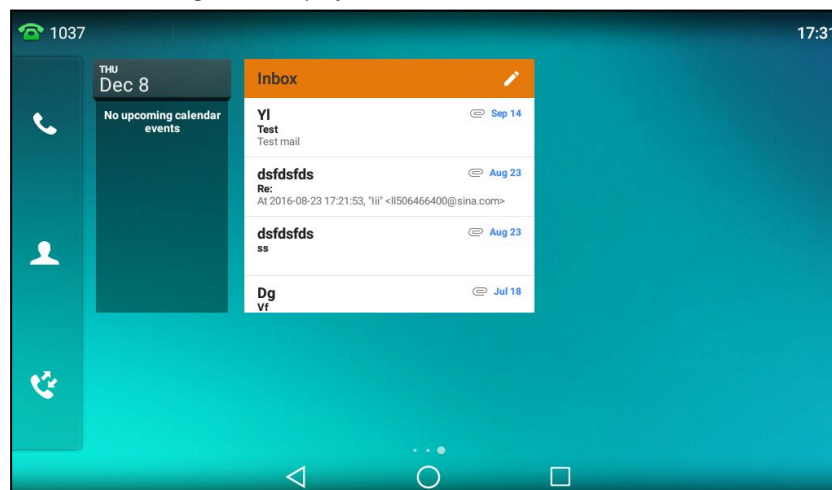

You can drag up and down to scroll through emails in inbox folder, and tap the desired email to view. You can also tap  on the top-right of the widget to compose and send an email.

Related Topic

[Adding APP Accounts](#)

Sending Files via Email

The Gallery and File Manager applications support data transfer via Email. You can send pictures, audios or videos as mail attachments to another account.

Related Topic

[Sharing Pictures/Videos/Audios via Email](#)

Browser

The use of browser applications is similar to PC's web browser, which allows you to browse web pages, set bookmarks, set home pages, clear history records, and so on. The default home page is the Yealink website.

Topics

[Browsing a Web Page](#)

[Managing Bookmarks](#)

[Setting a Home Page](#)

[Clearing the Navigation History](#)

[Modifying Browser Settings](#)

Browsing a Web Page

Procedure

1. Swipe left or right to go to the second idle screen.
2. Tap  to launch the **Browser** application.
3. Enter a part of URL in the address input field of the browser.
The phone will automatically retrieve and list similar websites.

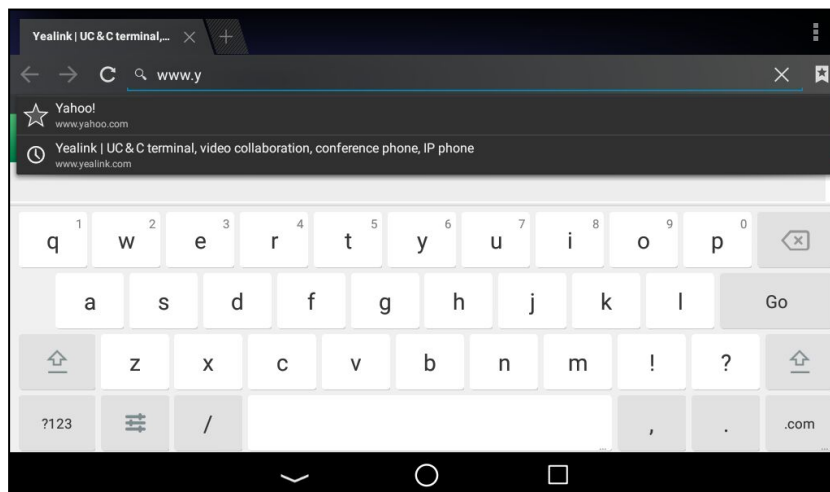

4. Tap the website you want to visit or enter the full URL then tap **Go** on the onscreen keyboard to browse the web page.

Managing Bookmarks

You can bookmark the web pages that you frequently visit.

Topics

[Adding a Web Page to the Bookmarks List](#)



[Opening a Web Page from the Bookmarks List](#)

[Editing a Bookmark](#)

[Deleting a Bookmark](#)

Adding a Web Page to the Bookmarks List



Procedure

1. Swipe left or right to go to the second idle screen.
2. Tap  to launch the **Browser** application.
3. Open the web page you want to bookmark.
4. Tap .
5. Edit the bookmark information in corresponding fields.
6. Tap **OK**.

The web page is added to the **BOOKMARKS** list.

Opening a Web Page from the Bookmarks List

Procedure

1. Swipe left or right to go to the second idle screen.
2. Tap  to launch the **Browser** application.
3. Tap  to access the **BOOKMARKS** list.

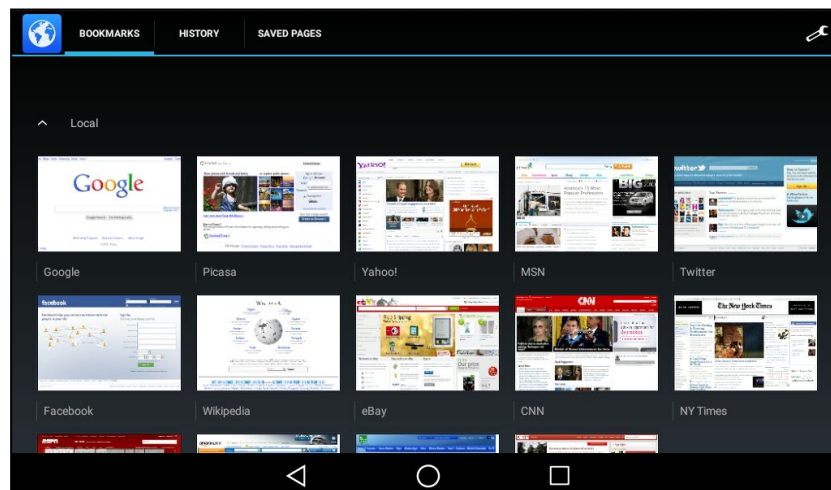

The all pre-configured bookmarks are in the list.



4. Tap the web page you want to visit.

Editing a Bookmark

Procedure

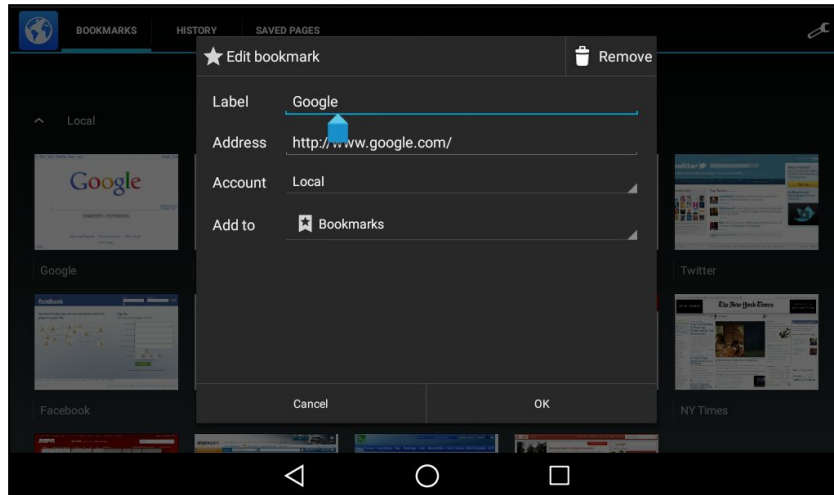

1. Swipe left or right to go to the second idle screen.
2. Tap  to launch the **Browser** application.
3. Tap  to access the **BOOKMARKS** list.
The all pre-configured bookmarks are in the list.
4. Long tap the bookmark you want to edit.
5. Tap **Edit bookmark** in the pop-up dialog box.
6. Edit the bookmark.



7. Tap **OK**.

Deleting a Bookmark



Procedure

1. Swipe left or right to go to the second idle screen.
2. Tap  to launch the **Browser** application.
3. Tap  to access the **BOOKMARKS** list.
The all pre-configured bookmarks are in the list.
4. Long tap the bookmark you want to delete.
5. Tap **Delete bookmark** in the pop-up dialog box.
6. Tap **OK**.

Setting a Home Page

You can set the web page you visit most frequently as the home page. This web page opens automatically each time you open the browser.



Procedure

1. Swipe left or right to go to the second idle screen.
 2. Tap  to launch the **Browser** application.
 3. Tap .
 4. Tap **Settings->General->Set homepage**.
 5. Tap the web page you want to set as the home page in the pop-up dialog box.
- You can also long tap a web page in **BOOKMARKS** list and then tap **Set as homepage**.

Clearing the Navigation History



You can periodically clear your navigation history to protect your privacy and prevent information disclosure.

Procedure

1. Swipe left or right to go to the second idle screen.
2. Tap  to launch the **Browser** application.
3. Tap .
4. Tap **Settings**->**Privacy & security**->**Clear history**.
The touch screen prompts "Delete the browser navigation history?".
5. Tap **OK**.

Modifying Browser Settings

Procedure

1. Swipe left or right to go to the second idle screen.
2. Tap  to launch the **Browser** application.
3. Tap .
4. Tap **Settings**.
5. Customize the browser style you want.

Calendar

You can use the **Calendar** application to synchronize events from email account as well as creating, modifying and viewing the events. The IP phone also provides notification for the upcoming events from the Calendar.

Topics

[Signing In Calendar](#)

[Creating an Event](#)



[Checking Events](#)

[Modifying the Calendar Settings](#)

Signing In Calendar

Before creating an event, you should sign in an email account first. If you have registered an account on the **Email** application already, you can skip this operation.

Procedure

1. Swipe left or right to go to the second idle screen.
2. Tap  to launch **Calendar** application.
3. Tap .

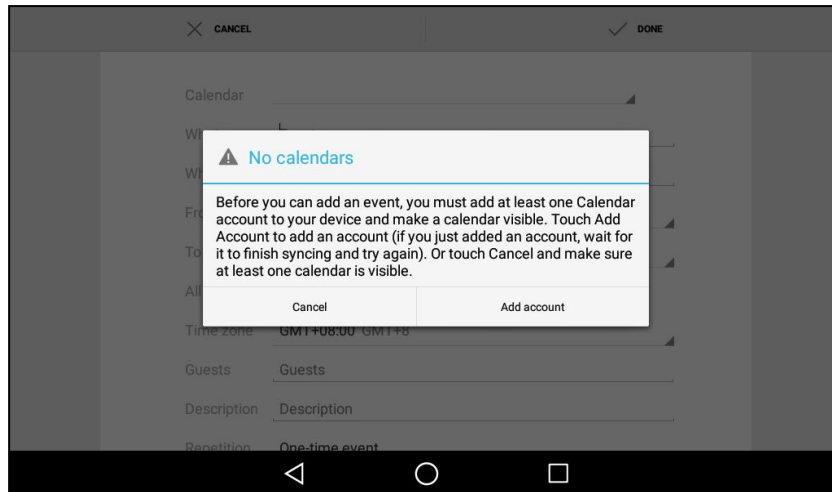



4. Tap **Add account**.
5. Sign in the Calendar according to the setup wizard.

Related Topic

[Adding APP Accounts](#)

Creating an Event

Procedure

1. Swipe left or right to go to the second idle screen.
2. Tap  to launch the **Calendar** application.
3. Select the desired date.
4. Tap  .

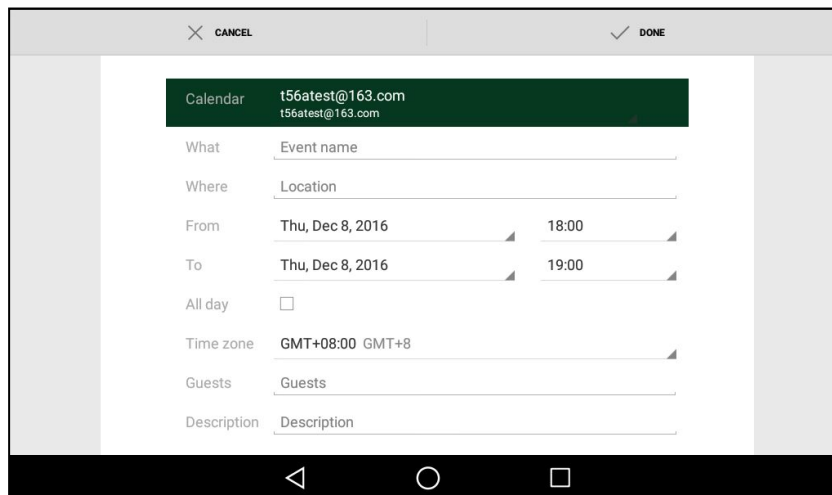

5. Edit the event.
6. Tap **DONE**.

Checking Events

On the calendar screen, you can check the information about an event you have added.

Procedure

1. Swipe left or right to go to the second idle screen.
2. Tap  to launch **Calendar** application.
3. (Optional.) Tap the current date (for example, **December 2016**) displayed on the top-left of the touch screen.

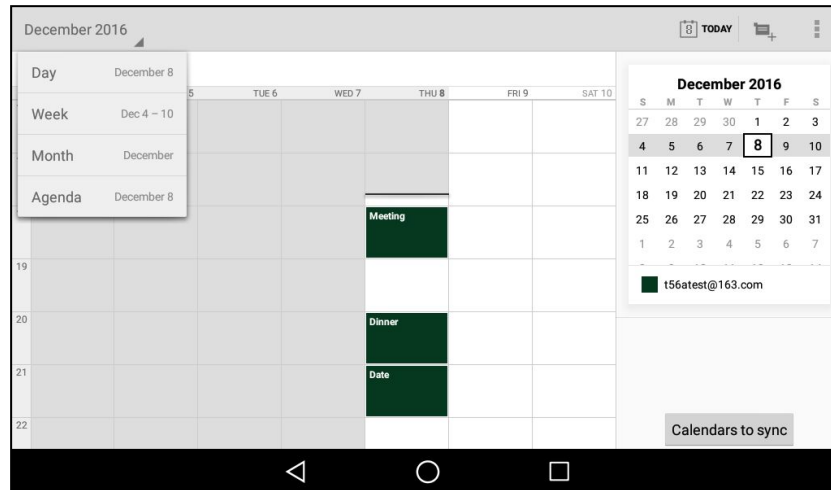

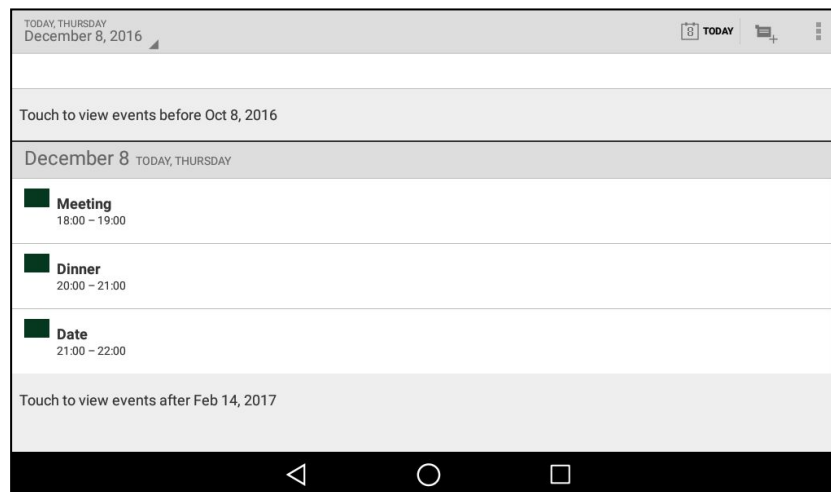

Tap **Day/Week/Month/Agenda** to select different time format to view the calendar.

In the agenda view, the events you have added are displayed as a list. You can tap **Touch to view events before XXX/Touch to view events after XXX** to view all events.



Modifying the Calendar Settings

Procedure

1. Swipe left or right to go to the second idle screen.
2. Tap  to launch **Calendar** application.
3. Navigate to  -> **Settings**.
4. Customize the general settings and account settings.

Calculator

You can use the **Calculator** application to perform simple or complex calculations.

Procedure

1. Swipe left or right to go to the second idle screen.
2. Tap  to launch **Calculator** application.

Clock

You can use the **Clock** application to set an alarm, check the time of other cities in the world, calculate the lasting time of an event and set a timer.

Topics

[Alarm](#)
[Clock](#)
[Timer](#)
[Stopwatch](#)



Alarm

Topics

[Setting an Alarm Clock](#)
[Editing an Alarm Clock](#)
[Deleting an Alarm Clock](#)
[Setting the Alarm Sound](#)

Setting an Alarm Clock

Procedure

1. Tap the digital clock widget on the home screen.
2. Tap  on the top-left of the touch screen.
3. Tap .
4. Tap the desired number to enter the alarm time.
5. Tap **OK**.
The alarm clock you have set is displayed on the touch screen.

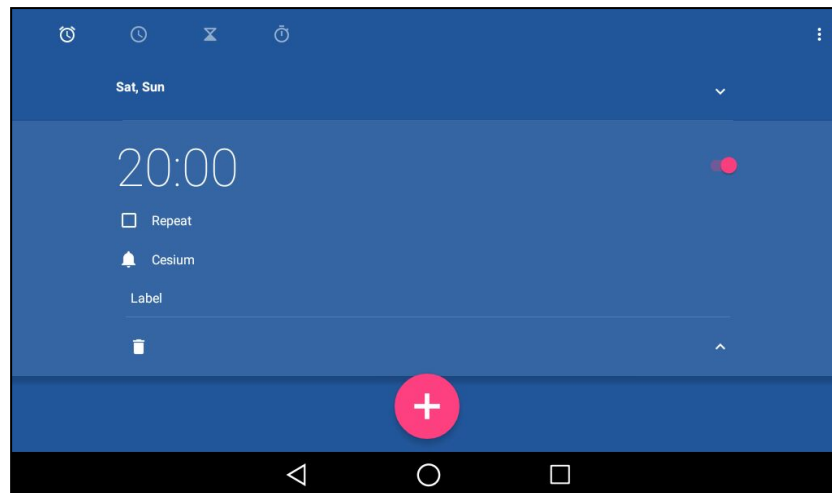

6. You can do the following:
- Check the **Repeat** checkbox, and then tap the repeat day of the alarm.
 - Tap .

Select a desired ringtone for the alarm, and then tap **OK**.
 - Tap the **Label** field.

Enter a label for the alarm, and then tap **OK**.

Note

If you have set the time format as **12 Hour**, you need to select **AM** or **PM** when setting the alarm time.



Editing an Alarm Clock

Procedure

1. Tap the digital clock widget on the home screen.
2. Tap  on the top-left of the touch screen.
3. Drag up and down to select the desired alarm.
4. Tap the desired option to edit the alarm clock.

Deleting an Alarm Clock

Procedure

1. Tap the digital clock widget on the home screen.
2. Tap  on the top-left of the touch screen.
3. Tap the desired alarm.
4. Tap  on the bottom-left of the alarm to delete the desired alarm.

Setting the Alarm Sound

Procedure

1. Tap the digital clock widget on the home screen.
2. Tap  on the top-left of the touch screen.

3. Tap  ->**Settings**.
4. You can do the following:
 - Tap the **Silence after** field, and then select the desired lasting time of the alarm bell in the pop-up dialog box. The alarm clock will automatically stop after this specified period of time.
 - Tap the **Snooze length** field, select the desired snooze time, and then tap **OK**.
 - Tap the **Alarm volume** field, drag the slider to adjust the alarm volume and then tap **OK**.
 - Tap the **Volume buttons** field, and then configure the desired function for the Volume key when the alarm is ringing.

Snooze: Press the Speakerphone key when the alarm is ringing, the alarm will stop and ring after a specified period of time.

Dismiss: Press the Speakerphone key when the alarm is ringing, the alarm will stop.

Do nothing: Press the Speakerphone key when the alarm is ringing, the alarm will still ring.

Clock

Topics



[Adding the Clock of Other Cities](#)

[Configuring the Clock Display Mode](#)

Adding the Clock of Other Cities

Procedure

1. Tap the digital clock widget on the home screen.

The touch screen displays the current date and time.
2. Tap .
3. Drag up and down to scroll through the cities.
4. Check the checkbox before the desired city.
5. Tap  to return to the clock screen.

The added clock of the desired city displays on the touch screen.

Configuring the Clock Display Mode

Procedure

1. Tap the digital clock widget on the home screen.
2. Tap  ->**Settings**.
3. You can do the following:
 - Tap the **Style** field.

Select **Analog** or **Digital** in the pop-up dialog box.
 - Check the **Automatic home clock** checkbox.
 - Tap the **Home time zone** field.

Select the desired time zone in the pop-up dialog box for the home clock.



Timer

Topic



[Setting a Timer](#)

Setting a Timer

Procedure

1. Tap the digital clock widget on the home screen.
2. Tap .
3. Enter the time by tapping the digits on the right of the screen.
You can tap  to delete the entered numbers.
4. Tap .

When the timer is running, you can do the following:

- Tap  to add an additional minute.
- Tap  to pause the timer.
- Tap  to delete the current timer

The timer beeps when the time is up. It keeps beeping until you tap to stop.







Stopwatch

Topic

[Setting a Stopwatch](#)

Setting a Stopwatch

Procedure

1. Tap the digital clock widget on the home screen.
2. Tap  on the top-left of the touch screen.
3. Tap .
4. You can do the following:
 - Tap  to pause the stopwatch.
 - Tap  to reset the stopwatch.
 - Tap , and then tap Bluetooth or Email to share the record via Bluetooth or email.
 - Tap  to add laps while the stopwatch is running.

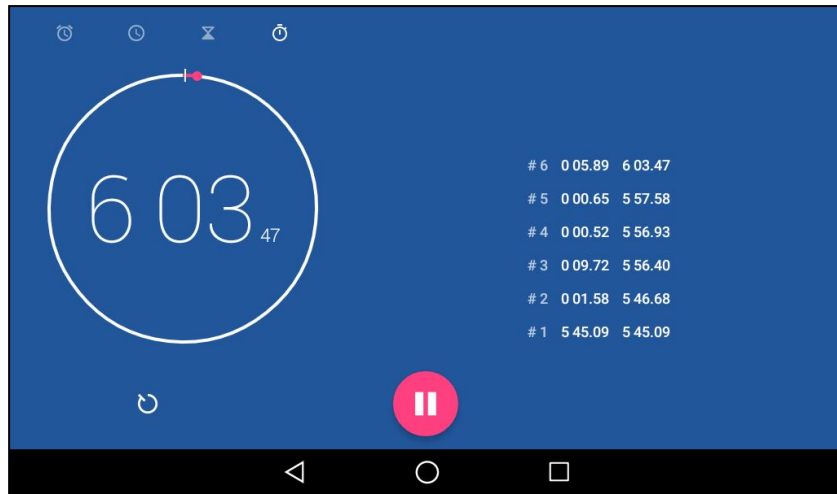

Related Topics

[Sending Files via Bluetooth](#)

[Sending Files via Email](#)

Optional Accessories with Your Phone

This section describes the optional accessories that you can use to extend your phone's capabilities.

Topics

[Supported Accessories](#)

[Headset](#)

[Expansion Module and Your Phone](#)

Supported Accessories

You can use your phone with different types of accessories. The following optional accessories need to be purchased separately if required for your particular phone:

- Headset YHS32/YHS33
- Expansion Module EXP50

Check with your system administrator to find out which of these applications or accessories are available on your phone.

Caution

We recommend that you use the accessories provided or approved by Yealink. The use of unapproved third-party accessories may result in poor performance.

Headset

Yealink IP phone supports wired headset, USB headset and Bluetooth headset to place and answer calls.

The IP phone will use the headset by the priority: USB/Bluetooth headset>YHS32/YHS33 headset.

Topics

[Analog Headset](#)

[Bluetooth Headset](#)

[USB Headset](#)

[Using Headsets](#)

Analog Headset

If you want to use an analog headset, you require an optional headset YHS32/YHS33.

Connecting a YHS32/YHS33 Headset

Procedure

1. Simply insert the headset connector into the headset port on the back of your IP phone.
For the information on how to connect headset YHS32/YHS33, refer to the YHS32/YHS33 user guide on [Yealink Technical Support](#) page.

Bluetooth Headset

You can use a Bluetooth headset to handle calls on the IP phones. If both a Bluetooth headset and an analog headset are connected, only the Bluetooth headset can be used.

For more information, refer to the documentation from your Bluetooth headset manufacturer.

Related Topics

[Pairing and Connecting the Bluetooth Headset](#)

[Disconnecting the Bluetooth Device](#)

[Analog Headset](#)

USB Headset

You can use a USB headset to handle calls on the IP phones.

For a list of supported headsets, refer to [Tested headset list compatible with Yealink IP Phone](#) for your IP phones on [Yealink Support](#). USB headsets that are not listed may not function properly if you connect them to your IP phone.

For more information on how to use your USB headset, refer to the related documentation from the manufacturer.

Connecting a USB Headset

Procedure

1. Simply insert the headset connector into the USB port on the back of your IP phone.
For the information on how to connect a USB headset, see the Quick Start Guide for your IP phone on [Yealink Support](#).

Using Headsets

You can use only one headset at a time. The IP phone will use the headset according to the priority: USB/Bluetooth headset > YHS32/YHS33.

Topics

[Activating the Headset Mode](#)

[Deactivating the Headset Mode](#)

Related Topics

[Switching Among the Handset, Speakerphone and Headset Modes](#)

Activating the Headset Mode

After connecting a headset to your phone, you can activate the headset mode and use the headset when answering and placing calls.

Procedure

1. Press the HEADSET  key on the phone.
The HEADSET key LED glows green, and the headset icon appears on the phone screen.

Deactivating the Headset Mode

If you do not want to use a headset to handle calls, you can deactivate the headset mode.

Procedure

1. Press the HEADSET key  again on the phone.
The HEADSET key LED goes out, and the headset icon disappears from the phone screen.

Expansion Module and Your Phone

The expansion module is a console you can use to connect to an IP phone to add additional line keys and expand the functions of your phone. It features a large graphic color phone screen and provides 20 physical keys with dual-color LEDs and three display pages, supporting a total of 60 keys. When you change the backlight intensity, power saving and screen saver settings on your IP phones, the EXP50 connected to your phone automatically changes to match the new settings.

For more information on expansion module EXP50, refer to the LCD Expansion Module EXP50 user guide on [Yealink Technical Support](#) page.

Topics

- [Connecting the Expansion Module](#)
- [Assigning the Features for Ext Keys](#)
- [Adjusting the Screen Saver of Expansion Module](#)
- [Adjusting the Backlight of Expansion Module](#)
- [Changing the EXP Wallpaper from Phone](#)
- [Adding an EXP Wallpaper from a USB Flash Drive](#)

Connecting the Expansion Module

Procedure

1. Connect the expansion module to the IP phone using the supplied connecting sheet and screws.
2. Connect the supplied cable from the USB jack on the host phone to the mini USB jack on the expansion module.

Assigning the Features for Ext Keys

If EXP50 is connected to the phone, you can customize features for ext keys.

Procedure

1. Long press the desired key on the EXP50.
The IP phone touch screen will enter the user setting interface of this key.
2. Select the desired key type from the **Type** field.
3. Configure the settings for the corresponding key type.
For example, if you want a line key for intercom, configure the **Account ID**, **Lable**, **Value**, and **Extension** for the line key.
4. Tap .

Adjusting the Screen Saver of Expansion Module

If you connect a color-screen expansion module EXP50 to the IP phones, the screen's intensity of both the phone and EXP50 will change synchronously.

Related Topic

[Screen Saver](#)

Adjusting the Backlight of Expansion Module

If you connect a color-screen expansion module EXP50 to the IP phones, the screen's intensity of both the phone and EXP50 will change synchronously.

Related Topics

[Changing the Backlight and Time on Idle Screen](#)

[Changing the Backlight on Control Center](#)

Changing the EXP Wallpaper from Phone

Procedure

1. Swipe left or right to go to the second idle screen.
2. Navigate to **Settings**->**Basic Settings**->**Display**->**EXP Background**->**Wallpapers**.
3. Select the desired wallpaper image.
4. Tap **Set as exp background**.

Note

The phone screen size is 7 inches (Resolution: 1024x600). The EXP50 screen size is 4.3 inches (Resolution: 272x480). If the size of the custom picture doesn't meet the IP phone/expansion module screen size, the wallpaper will be stretched or/and zoomed out according to the screen size.

Adding an EXP Wallpaper from a USB Flash Drive

When you set a picture in USB flash drive as EXP wallpaper, the picture is added to the EXP Wallpaper list.

EXP50 screens are 4.3 inches (Resolution: 272x480). We recommend you to add a picture less than 4.2 megapixels.

Either the smaller or larger picture will be scaled proportionally to fit the screen.

Before You Begin

Make sure that the picture is in the root directory of your USB flash drive, and the USB flash drive is connected to your EXP50 successfully.

Procedure

1. Swipe left/right to go to the second idle screen.
2. Navigate to **Settings**->**Basic Settings**->**Display**->**EXP Background**->**Wallpapers**.
3. Select the desired wallpaper.
4. Tap **Set as exp background**.

Using Handsets on T58V/T58A/T56A Phone

You can turn Yealink SIP-T58V/T58A/T56A phone to the corded-cordless phone. The corded-cordless phone consists of a T58V/T58A/T56A phone, a DECT USB dongle DD10K and a handset. The supported handsets include W52H, W56H, W53H and DD phone. The T58V/T58A/T56A phone acts as a base station and Handset 1. You can register up to other four handsets to one phone. It allows you to manage calls when you are away from your desk.

Note that you can still use the phone features as usual on the corded-cordless phone.

Topics

[Attaching the DECT USB Dongle DD10K](#)

[Handset Registration](#)

[DECT Intercom](#)

[Repeater Mode](#)

[Master-Slave Mode](#)

[Shared Directory](#)

[Renaming the Handset](#)

[Locating a Handset](#)

[Changing Base PIN](#)

Attaching the DECT USB Dongle DD10K

Procedure

1. Attach the DD10K into the rear USB port on the phone.

Handset Registration

After [attaching the DD10K](#), you can register up to four handsets to your phone.

Topics

[Setting the Phone to the Handset Registration Mode](#)

[Registering a Handset](#)

[De-registering a Handset on the Handset](#)

[De-registering a Handset on the Phone](#)

Setting the Phone to the Handset Registration Mode

Before You Begin

Make sure you have attached a DD10K to the phone.

Procedure

1. Swipe left or right to go to the second idle screen.
2. Navigate to **DECT Settings**->**Handsets**.
3. Tap **Register**.
The phone is in the handset registration mode now.

Related Topic

[Attaching the DECT USB Dongle DD10K](#)

Registering a Handset

Before You Begin

The handset registration mode is enabled on your phone.

Procedure

1. Do one of the following on the handset:
 - Navigate to **OK**->**Register Handset**.
 - Navigate to ->**Settings**->**Registration**->**Register Handset**.

The handset begins searching the phone.

2. Press **OK** after a phone is found.
3. Enter the base PIN (default: 0000), and then press **OK**.

The handset screen displays a message prompting you that the handset is registered successfully.

Tip

You can also press **Reg** on the handset to register the handset quickly.

Related Topic

[Setting the Phone to the Handset Registration Mode](#)

De-registering a Handset on the Handset

Procedure

1. Navigate to **OK**->**Settings**->**Registration**->**De-reg. Handset**.
2. Enter the base PIN (default: 0000), and then press **Done**.

The screen displays the handset names that registered to the same phone. The name of your handset itself is high-lighted.

3. Highlight the desired handset and then press **OK**.
The phone screen prompts you whether to de-register the handset.
4. Press **Yes**.

Related Topic

[De-registering a Handset on the Phone](#)

De-registering a Handset on the Phone

Procedure

1. Swipe left or right to go to the second idle screen.
2. Navigate to **DECT Settings**->**Handsets**.
3. Select a registered handset.
4. Tap **Delete**.
5. Enter the base PIN (default: 0000), and then tap **OK**.

Related Topic

[De-registering a Handset on the Handset](#)

DECT Intercom

When the handset is registered to the phone successfully (refer to [Handset Registration](#)), you can place/receive a DECT intercom call to/from the handset registered to your phone.

Topics

[Configuring Auto Intercom](#)

[Placing a DECT Intercom Call on the Handset](#)

[Placing a DECT Intercom Call on the Phone](#)

[Placing a DECT Intercom Call with a DECT Intercom Key](#)

[Performing a Blind Transfer to the Handset](#)

[Merging the DECT Intercom Call with SIP Call into a Conference](#)

Configuring Auto Intercom

You can configure the phone to automatically answer an incoming internal intercom call and plays a warning tone.

The following types of warning tones are available:

- **On (Beep On):** The phone answers an incoming internal intercom call automatically and plays a warning tone.
- **On (Beep Off):** The phone answers an incoming internal intercom call automatically without a warning tone.
- **Off:** Auto intercom feature is off. You need to answer an incoming internal intercom call manually.

Procedure

1. Swipe left or right to go to the second idle screen.
2. Navigate to **DECT Settings**->**Auto Intercom**.
3. Select a desired option from the **Auto Intercom** field.
4. Tap .

Note

Your system administrator can configure the auto intercom feature for your phone and the registered handsets at the same time.

Placing a DECT Intercom Call on the Handset

You can place a DECT intercom call to a handset registered to the same phone, or place a DECT intercom call to the phone that you register the handset to.

Up to two intercom calls can be set up on the handset.

Procedure

1. Navigate to **OK**->**Intercom**.
The phone screen displays all registered handset names and the **All Handsets** option.
2. Highlight the desired handset or **T58 Phone**.
3. Press **OK** to dial out.

Related Topics

[Handset Registration](#)

[Placing a DECT Intercom Call on the Phone](#)

Placing a DECT Intercom Call on the Phone

You can place a DECT intercom call to a handset registered to the phone.

Procedure

1. Navigate to  -> **DECT Intercom**.
The phone screen displays all registered handset names.
2. Tap the desired handset.
The corresponding handset will ring.

Related Topics

[Handset Registration](#)

[Placing a DECT Intercom Call on the Handset](#)

Placing a DECT Intercom Call with a DECT Intercom Key

You can quickly dial a handset registered to your phone through one touch.

Topics

[Setting a DECT Intercom Key Manually](#)

[Placing a DECT Intercom Call Using a DECT Intercom Key](#)

Setting a DECT Intercom Key Manually

You can set a line key as a DECT intercom key for a handset.

Procedure

1. Swipe left or right to go to the second idle screen.
2. Navigate to **Settings**->**Features**->**Dsskey**.
3. Tap the desired line key.
4. Select **DECT Intercom** from the **Type** field.
5. Select a target handset from the **Select handset** field.
6. (Optional.) Enter the string that will appear on the phone screen in the **Label** field.
7. Tap .

Tip

You can drag the line key to the **Edit** field to set a DECT Intercom key.

Placing a DECT Intercom Call Using a DECT Intercom Key

Before You Begin

You need to set a line key as a DECT Intercom key.

Procedure

1. Tap a DECT Intercom key when the phone is idle.

Related Topic

[Setting a DECT Intercom Key Manually](#)

Performing a Blind Transfer to the Handset

You can quickly transfer a SIP call to the handset registered to your phone.

Procedure

1. When the phone is during a call, do one of the following:
 - Drag the far-site window to a DECT intercom key.
 - Tap **Transfer**.

Navigate to  -> **DECT Intercom**.

Tap the desired handset.

Related Topic

[Setting a DECT Intercom Key Manually](#)

Merging the DECT Intercom Call with SIP Call into a Conference

Procedure

1. Place a DECT intercom call and a SIP call on the phone.
2. Do one of the following:
 - Drag one far-site window to the other far-site window.
Tap **Conference** from the pop-up box.
 - Tap the desired call for a conference and ensure that the call is active.
Tap **Conference**.
Tap the Hold call to join the calls in the conference.

Repeater Mode

Repeater mode extends the radio coverage of the phone. The repeater has the same radio coverage as the base station. This feature is especially useful for users who require mobility in large dwellings. If the repeater mode is enabled, and a repeater is registered to the base station, the handset registered to the base station can be used either in the base station or the repeater coverage area, thereby providing users with greater freedom in mobility.

Yealink SIP-T58V/T58A/T56A phone is compatible with DECT repeater RT10/RT20/RT20U/RT30.

Topics

[Enabling the Repeater Mode](#)

[Setting the Phone to the Repeater Registration Mode](#)

[Registering a Repeater](#)

Enabling the Repeater Mode

Procedure

1. Swipe left or right to go to the second idle screen.
2. Navigate to **DECT Settings**->**Repeater Mode**.

3. Select a repeater from the **Repeater Mode** field.
4. Tap .
The phone screen prompts you whether to reboot the dongle.
5. Tap **OK**.
The repeater mode is enabled after the dongle reboot.

Setting the Phone to the Repeater Registration Mode

Before You Begin

Make sure the repeater mode is enabled on your phone.

Procedure

1. Swipe left or right to go to the second idle screen.
2. Navigate to **DECT Settings**->**Handsets**.
3. Tap **Register Repeater**.
The phone is in the repeater registration mode now.

Related Topic

[Enabling the Repeater Mode](#)

Registering a Repeater

Before You Begin

The repeater mode is enabled, and the phone is in the repeater registration mode.

Procedure

1. Plug the repeater into an AC outlet.
POWER LED glows green and DECT LED flashes red.
2. Enable the repeater registration mode on the phone.
If a phone is found, DECT LED will flash orange.

When DECT LED glows green/orange, the registration to the phone is successful.

Related Topics

[Enabling the Repeater Mode](#)

[Setting the Phone to the Repeater Registration Mode](#)

Master-Slave Mode

You can use the SIP-T58V/T58A/T56A phone as a master handset while binding a slave handset to it. After binding, the account of the phone is applied to the slave handset, and all line status (for example, DND, forward) on the phone and slave handset are synchronized.

You can use the phone while you are sitting at your desk, and use the slave handset while away from your desk to enhance your business activities.

The master phone and the slave handset can share contacts. For more information, refer to [Shared Directory](#).

Master-Slave mode is available only when one handset is registered. For more information, refer to [Handset Registration](#).

Note

After the handset is bound to your phone as a slave handset, the assigned outgoing/incoming line(s) configured for the handset by your administrator is disabled.

Topics

[Selecting a Slave Handset for Your Phone](#)

[Push an Active Call to the Slave Handset](#)

[Pull an Active Call from the Slave Handset](#)

Selecting a Slave Handset for Your Phone

You can select a slave handset for the phone, and configure a mode for whether to continue the conversation when the phone goes off hook.

There are two slave modes:

- **Busy:** You cannot switch the active call between the phone and slave handset. Regardless of the master handset or the slave handset, the device which is during the call can initiate a new call. If you try to initiate a call on the phone/handset, the phone/handset screen will prompt "Path Busy".
- **Take over call:** When the slave handset is during the call, you can retrieve the call from the handset on the phone after off-hook. When the phone is during the call, you can push the call to the slave handset.

Procedure

1. Swipe left or right to go to the second idle screen.
2. Navigate to **DECT Settings**->**Select Slave**.
3. Select the desired handset.
4. Select a mode from the **Select mode:** field.
5. Tap .

Related Topics

[Pull an Active Call from the Slave Handset](#)

[Push an Active Call to the Slave Handset](#)

Push an Active Call to the Slave Handset

You can push the active call of the phone to the slave handset.

Before You Begin

The master phone is during a call, and the slave mode is selected as **Take over call**. And make sure there is only one call on the phone.

Procedure

1. Swipe the soft key area left and then tap **Call Shift**.
The call is automatically connected on the slave handset.

Related Topic

[Selecting a Slave Handset for Your Phone](#)

Pull an Active Call from the Slave Handset

You can retrieve the call from the slave handset on the phone after off-hook.

Before You Begin

The slave handset is during a call, and the slave mode is selected as **Take over call**. And make sure there is only one call on the handset.

Procedure

1. Do one of the following:
 - Pick up the handset.
 - Press the Speakerphone key.
 - Tap the line key, and then tap **Call Pull**.The call is connected to the phone.

Related Topic

[Selecting a Slave Handset for Your Phone](#)

Shared Directory

Your phone and the slave handset can share the contacts. You can store up to 1000 contacts in your phone's shared directory, and edit, delete, search or simply dial a contact from the shared directory.

Check with your system administrator to find out if this feature is available on your phone.

Note

For more information on how to bind a slave handset, refer to [Selecting a Slave Handset for Your Phone](#).

Topics

[Adding Shared Contacts](#)

[Editing Shared Contacts](#)

[Deleting a Shared Contact](#)

[Deleting All Shared Contacts](#)

[Searching for Shared Directory Contacts](#)



[Moving a Shared Contact to the Blacklist Directory](#)

[Moving a Shared Contact to the Local Directory](#)

[Placing a Call from the Shared Directory](#)

Adding Shared Contacts



Procedure

1. Navigate to  -> **Share Directory**.
2. Tap .
3. Enter the name and the office, mobile or other number in the corresponding fields.
4. Tap .

If the contact already exists in the shared directory, the phone will prompt "Contact name existed!".



Editing Shared Contacts

Procedure

1. Navigate to  -> **Share Directory**.
2. Tap  beside the contact.
3. Edit the shared contact information.
4. Tap .

Deleting a Shared Contact

Procedure



1. Navigate to  -> **Share Directory**.
2. Tap  beside the contact.
3. Tap **Delete**.
The phone prompts whether to delete the contact.
4. Tap **OK** to delete.

Related Topic

[Deleting All Shared Contacts](#)

Deleting All Shared Contacts

Procedure

1. Navigate to  -> **Share Directory**.
2. Tap **Setting**.
3. Tap the **Select All** radio box.
4. Tap .
- The phone prompts whether to delete all contacts.
5. Tap **OK** to delete to delete.

Related Topic

[Deleting a Shared Contact](#)

Searching for Shared Directory Contacts



In the Shared Directory, you can enter search criteria to find your desired contact quickly.

Procedure

1. Navigate to  -> **Share Directory**.
2. Tap **Search**.
3. Enter the name or number you are looking for in the search field.
The contacts will be displayed in the result list.



Moving a Shared Contact to the Blacklist Directory

Procedure

1. Navigate to  -> **Share Directory**.
2. Tap  beside the contact.
3. Tap **Blacklist**.
The phone screen prompts you whether to move the contact.
4. Tap **OK**.

Moving a Shared Contact to the Local Directory

Procedure

1. Navigate to  -> **Share Directory**.
2. Tap **Setting**.
3. Select a contact.
4. Tap .
5. Tap **New Entry**.
6. Tap .

Placing a Call from the Shared Directory

Procedure

1. Navigate to  -> **Share Directory**.
2. Tap the desired contact.
If the selected contact has multiple numbers, tap the desired number.

Related Topic

[Searching for Shared Directory Contacts](#)

Renaming the Handset

You can personalize the handset name on the phone.

Procedure

1. Swipe left or right to go to the second idle screen.
2. Navigate to **DECT Settings**-> **Handsets**.
3. Tap  beside the handset name.

Locating a Handset

You can locate a misplaced registered handset by the phone.

Procedure

1. Swipe left or right to go to the second idle screen.
2. Navigate to **DECT Settings**->**Handsets**.
3. Tap **Start Paging**.

All handsets that are registered to the phone will ring (paging) simultaneously and display the IP address of the phone on the screen.

You can tap **Stop Paging** on the phone to end ringing (paging).

Changing Base PIN

To avoid unauthorized registration or access to some features on the phone, you should keep the base PIN secret.

Procedure

1. Swipe left or right to go to the second idle screen.
2. Navigate to **DECT Settings**->**Change Base PIN**.
3. Enter the current PIN (default: 0000) in the **Change Base PIN** field.
4. Enter the new PIN in the **Enter New PIN** and **Re-enter new PIN** fields.
5. Tap .

Note

If the double PIN feature is enabled by your system administrator, you can only use the registration PIN to register a handset. Contact your system administrator for more information.

Maintaining Your Phone

When your phone is unable to operate properly, you need to investigate or troubleshoot issues among other tasks your system administrator may ask you to perform.

Topics

[Investigating Warnings](#)

[Clearing Warnings](#)

[Rebooting Your Phone](#)

[Resetting to Factory Settings](#)

[Updating the Phone Configuration](#)

Investigating Warnings

A warning icon  is displayed in the status bar when the default password is used. The warning icon is used to remind you to change the default password as soon as possible. You can view details about the issue from **Status** screen.

Procedure

1. Swipe left or right to go to the second idle screen.
2. Navigate to **Settings**->**Status**->**General**.
The warning detail is displayed in the **Warning** field.

Related Topics

[Clearing Warnings](#)

[Changing the Administrator Password](#)

Clearing Warnings

You can temporarily remove the warning icon from the status bar. However, the warning message still is displayed on the **Status** screen until the issue is fixed.

The warning icon appears in the status bar again after reboot if the issue is not fixed.

Procedure

1. Swipe left or right to go to the second idle screen.
2. Navigate to **Settings**->**Status**->**General**.
3. Tap the **Warning** field.
The phone screen prompts you whether to clear the warning icon.
4. Tap **OK**.
The warning icon  is removed from the status bar. And it is also removed from the **Warning** field.

Tip

You can also swipe left or right to temporarily remove the warning icon via Notification Center.

Related Topics

[Investigating Warnings](#)

[Control Center/Notification Center](#)

Rebooting Your Phone

The improper operation may cause malfunction. If the malfunction occurs, your system administrator may ask you to reboot your phone.

Procedure

1. Swipe left/right to go to the second idle screen.
2. Navigate to **Settings**->**Advanced Settings** (default password: admin)->**Reboot**->**Reboot**.
The phone screen prompts you whether to reboot the phone.
3. Tap **OK** to reboot the phone.

Tip

You can also long press the * key on the keypad when the phone is idle to reboot the phone.

Resetting to Factory Settings

Generally, some common issues may occur while using the IP phone. Your system administrator may ask you to reset your phone to factory configurations after you have tried all troubleshooting suggestions but still do not solve the problem. This operation will delete all your personal configuration settings, and reset all settings to the factory defaults. Check with your system administrator if the personalized settings are kept before resetting your phone to factory settings.

Procedure

1. Swipe left/right to go to the second idle screen.
2. Navigate to **Settings**->**Advanced Settings** (default password: admin)->**Reset Config**.
2. Tap **Reset to Factory Settings**.
The phone screen prompts you whether to reset the setting.
3. Tap **OK**.
The phone begins resetting.

Tip

You can also long press the Redial key when the phone is idle.

After reset, the screen prompts "Welcome Initializing...Please wait".

The phone will be reset successfully after startup.

Note

Reset of your phone may take a few minutes. Do not power off until the phone has started up successfully.

Updating the Phone Configuration

Your system administrator may ask you to update your phone configurations.

Procedure

1. Swipe left or right to go to the second idle screen.
2. Navigate to **Settings**->**Advanced Settings** (default password: admin)->**Auto Provision**.

2. Enter the provision information in the corresponding field.
3. Tap  .
The phone screen prompts you whether to provision now.
4. Tap **OK**.

Appendix - Menu Structure

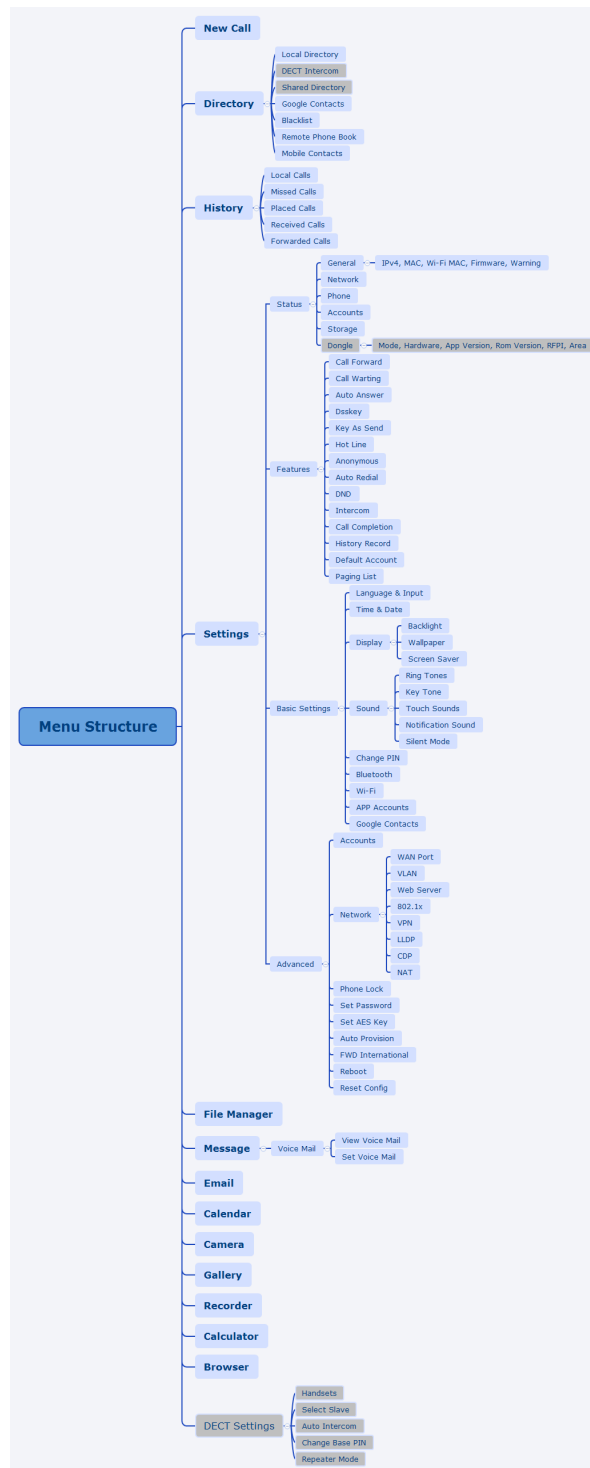

Note

The menus with gray box are not available when the DECT USB dongle DD10K is not attached to the phone.