

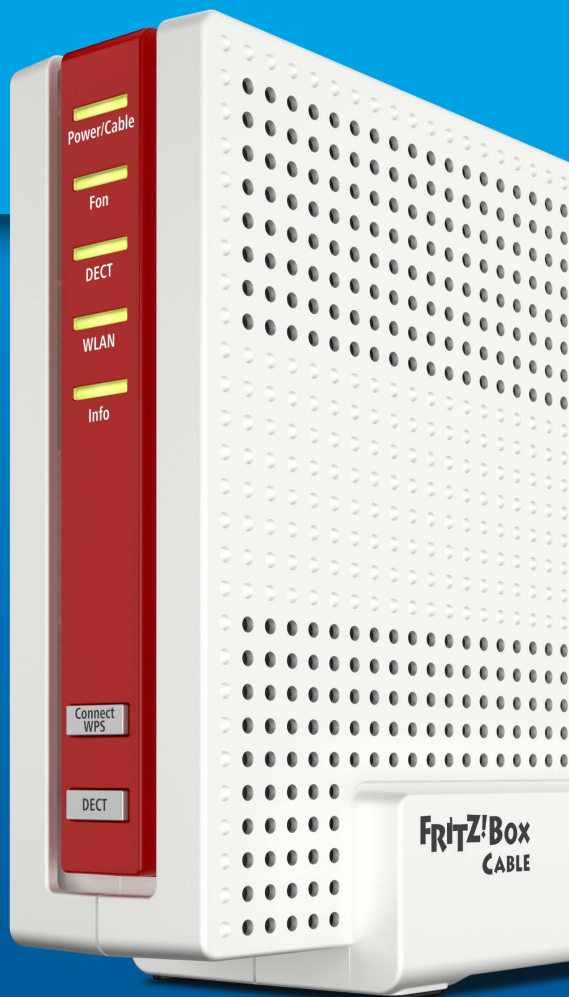

# FRITZ!Box 6591 Cable



## Configuration and Operation

# Table of Contents

<b>General Remarks</b> .....	<b>7</b>
Safety Instructions .....	8
Instructions and Help .....	12
Symbols Used.....	14
Device Data on the Type Label .....	15
Package Contents .....	16
<b>Functions and Structure</b> .....	<b>17</b>
Functions .....	18
Connection Sockets .....	21
Buttons .....	23
LEDs .....	24
Requirements for Operation .....	26
<b>Connecting</b> .....	<b>27</b>
Overview: Connecting the FRITZ!Box.....	28
Placement.....	29
Connecting to the Internet: Possibilities.....	31
Connecting with the Internet Access: Cable Connection .....	32
Connecting to Electrical Power .....	33
Connecting with the Internet Access: Mobile Network .....	34
Connecting a Computer with a Network .....	36
Connecting the Computer via Wireless LAN .....	38
Connecting Telephones .....	42
Connecting Smartphones .....	47
Connecting a Door Intercom System .....	49
<b>User Interface</b> .....	<b>50</b>
Opening the User Interface.....	51
Using the Wizard for Basic Configuration .....	54

Logging Out of the User Interface .....	56
Using the Standard View and Advanced View.....	58
<b>Configuring .....</b>	<b>59</b>
Overview: Configuring the FRITZ!Box.....	60
Configuring Internet Access via the Cable Connection .....	61
Setting Up Internet Access via the Mobile Network .....	62
Extending Wireless LAN Range .....	63
Expanding a Wireless Radio Network .....	64
Configuring Your Telephone Numbers .....	66
Configuring Telephones .....	67
Configuring a Door Intercom System .....	69
Saving Power with the FRITZ!Box.....	70
<b>Mesh with FRITZ! .....</b>	<b>72</b>
Mesh in the Home Network of the FRITZ!Box .....	73
Updating the FRITZ!Box for Mesh.....	75
Integrating FRITZ!WLAN Repeater into the FRITZ!Box Mesh .....	76
Integrating FRITZ!Powerline into the Mesh of the FRITZ!Box .....	78
Deploying an Additional FRITZ!Box as a Mesh Repeater .....	80
Using Telephony in the Mesh .....	81
<b>User Interface: Overview menu.....</b>	<b>82</b>
Overview Menu: Settings and Features .....	83
<b>User Interface: Internet menu.....</b>	<b>86</b>
Internet Menu: Settings and Features .....	87
Using AVM Services for Diagnostics and Maintenance .....	88
Configuring Parental Controls .....	90
Creating and Assigning Access Profiles .....	92
Editing Filter Lists .....	94
Configuring Priorities for Internet Use .....	95
Configuring Port Sharing.....	96
Enabling Dynamic DNS.....	98
Remote Access to the FRITZ!Box .....	99

Configuring VPN Remote Access.....	101
Configuring IPv6 .....	103
<b>User Interface: Telephony Menu.....</b>	<b>105</b>
Telephony Menu: Settings and Features .....	106
Configuring and Using the Telephone Book .....	107
Configuring and Using the Answering Machine.....	109
Using the Fax Function.....	111
Configuring Call Diversion .....	112
Configuring Call Blocks .....	113
Configuring Do Not Disturb .....	115
Setting an Alarm .....	116
Configuring a Dialing Rule .....	117
<b>User Interface: Home Network menu.....</b>	<b>118</b>
Home Network Menu: Settings and Features.....	119
Managing the Home Network.....	120
Managing Network Devices .....	123
Changing IPv4 Settings .....	126
Distributing IPv4 Addresses .....	129
Changing IPv6 Settings .....	132
Configuring a Static IP Route .....	134
Obtaining an IP Address Automatically .....	136
Configuring LAN Guest Access .....	138
Configuring Wake on LAN .....	140
Configuring USB Devices .....	141
Configuring and Using the Media Server .....	149
Assigning a FRITZ!Box Name .....	151
Controlling Smart Home Devices .....	152
<b>User Interface: Wireless Menu.....</b>	<b>155</b>
Wireless Menu: Settings and Features.....	156
Switching the Wireless Radio Network On and Off .....	157

Selecting the Radio Channel.....	158
Configuring Wireless Guest Access .....	160
<b>User Interface: DECT Menu .....</b>	<b>164</b>
DECT Menu: Settings and Features.....	165
Enabling DECT Eco.....	166
Allowing Non-encrypted Connections .....	167
Switching DECT On and Off.....	168
<b>User Interface: Diagnostics Menu.....</b>	<b>169</b>
Diagnostics Menu: Settings and Features.....	170
Starting the Function Diagnostics .....	171
Using Security Diagnostics .....	173
<b>User Interface: System Menu.....</b>	<b>176</b>
System Menu: Settings and features.....	177
Configuring Push Services .....	179
Selecting Signaling of the “Info” LED .....	181
Locking Buttons.....	182
Configuring FRITZ!Box Users and FRITZ!Box Password .....	183
Saving Settings .....	188
Loading Settings .....	189
Restarting the FRITZ!Box .....	190
Updating FRITZ!OS .....	191
Restoring Factory Settings .....	196
Changing the Language of the User Interface .....	198
Changing Regional Options.....	199
Adjusting the Time Zone.....	200
<b>User Interface: Wizards Menu .....</b>	<b>201</b>
Using Wizards .....	202
<b>FRITZ!NAS .....</b>	<b>204</b>
FRITZ!NAS Features.....	205
Expanding FRITZ!NAS Storage.....	207

Displaying FRITZ!NAS in a File Manager.....	208
Saving FRITZ!NAS Storage .....	209
<b>MyFRITZ! .....</b>	<b>210</b>
What Is MyFRITZ!?.....	211
Creating a MyFRITZ! Account .....	214
Configuring MyFRITZ!App: with Android .....	215
Configuring MyFRITZ!App: with iOS .....	216
<b>Controlling FRITZ!Box with Keypad Codes .....</b>	<b>217</b>
Information on Keypad Codes.....	218
Configuration on the Telephone.....	220
Operation at the Telephone.....	233
Restoring Factory Settings with the Telephone .....	245
<b>Malfunctions .....</b>	<b>247</b>
Troubleshooting Procedures.....	248
Troubleshooting Chart.....	249
Opening the User Interface with the Emergency IP Address .....	252
Knowledge Base .....	254
Support .....	255
<b>Decommissioning and Disposal.....</b>	<b>256</b>
Decommissioning.....	257
Disposal .....	258
<b>Appendix.....</b>	<b>259</b>
Technical Specifications.....	260
Legal.....	264
Information on Cleaning.....	268
<b>Index.....</b>	<b>269</b>

# General Remarks

Safety Instructions .....	8
Instructions and Help .....	12
Symbols Used .....	14
Device Data on the Type Label .....	15
Package Contents .....	16

## Safety Instructions

### Overview

Before connecting the FRITZ!Box, observe the following security instructions in order to protect yourself, the surroundings, and the FRITZ!Box from harm.

### Fires and Electrical Shocks

Overloaded outlets, extension cords and power strips can cause fires or electric shocks.

Outdated electrical or incorrect broadband cable installations can also present a fire hazard by allowing extremely high equalizing current to flow through your device.

- Avoid using socket strips and extension cords if at all possible.
- Do not connect multiple extension cords or socket strips to each other.
- Make sure that the electrical installation complies with the latest technical standards.
- Inform yourself about the performance of your electrical system, especially the power rating of power lines and outlets.
- Make sure that the earthing contacts of your power outlets are connected via a protective ground conductor that is earthed along with the cable network connection via the equipotential bonding bar, in accordance with the valid safety standards.
- When in doubt, ask the service technician performing installation or a competent electrician.

### Overheating

Heat accumulation can lead to overheating of the FRITZ!Box and subsequently damage the FRITZ!Box.

- Provide for sufficient air circulation around the FRITZ!Box.



- Make sure that the ventilation slits on the FRITZ!Box housing are always unobstructed.
- The FRITZ!Box should not be placed on carpets or upholstery.
- Do not cover the FRITZ!Box.

### Power Surges Caused by Lightning

During electrical storms, electrical surges caused by lightning present a danger to connected electrical devices.

- Do not install the FRITZ!Box during an electrical storm.
- During a storm, disconnect the FRITZ!Box from the power supply and from the cable connection.

### Moisture, Liquids and Vapors

Moisture, liquids and vapors that find their way into the FRITZ!Box can cause electric shocks or short circuits.

- Only use the FRITZ!Box indoors.
- Never let liquids get inside the FRITZ!Box.
- Protect the FRITZ!Box from vapors and moisture.

### Improper Cleaning

Improper cleaning with strong detergents, solvents or wet cloths can cause damage to the FRITZ!Box.

- Please refer to the information about how to clean your FRITZ!Box; [see Rules, page 268](#).

### Improper Opening and Repairs

The device contains hazardous components and should only be opened by authorized repair technicians.

- Do not open the FRITZ!Box housing.
- If the FRITZ!Box needs to be repaired, please take it to a specialized vendor.

## Internet Security

Comprehensive information about how to protect your FRITZ!Box and your home network from access by strangers is presented in the internet at:

[en.avm.de/guide](http://en.avm.de/guide)

## Radio and Electromagnetic Interference

Radio interference can be generated by every device that emits electromagnetic signals. With so many devices transmitting and receiving radio waves, interference can occur when radio waves overlap.

- Do not use the FRITZ!Box in places where the use of radio devices is prohibited.
- Follow any instructions to switch off radio devices – especially in hospitals, outpatient treatment centers, medical practices and other medical facilities – in order to prevent interference with sensitive medical equipment.
- Consult your doctor and the manufacturer of your medical device (pacemaker, hearing aid, electronically controlled implant, etc.) to find out whether it could be affected by interference from your FRITZ!Box.
- If applicable, maintain the recommended minimum distance of 15 cm recommended by the manufacturers of medical devices in order to prevent malfunctions of your medical device.

## Potentially Explosive Environments

Under unfavorable conditions, radio waves in the vicinity of explosive environments can cause fires or explosions.

- Do not install and operate your FRITZ!Box in the vicinity of explosive environments, flammable gases, areas in which the air contains chemicals or particles like grain, dust or metal powder, or in the vicinity of detonation grounds.
- In locations with potentially explosive atmospheres, and in the vicinity of detonation grounds, follow the instructions to switch off electronic devices in order to prevent interference with detonation and ignition systems.

## Instructions and Help

### Media

Use the comprehensive customer documentation to connect, configure and operate your FRITZ!Box.

The latest information on products, important developments or updates is presented in the social media.



After a FRITZ!OS update, download the latest manual from [en.avm.de/service/manuals](http://en.avm.de/service/manuals).

Medium	Contents	Location
Manual	Status FRITZ!OS version 07.01	<a href="http://en.avm.de/service/manuals">en.avm.de/service/manuals</a>
	Connecting, configuration and operation	
	Range of functions of your FRITZ! device	
	Technical specifications	
Quick guide	Connecting and configuration	Is provided in print with your FRITZ!Box
Online help	Instructions on configuration and operation	<a href="http://fritz.box/">http://fritz.box/</a>
	Help on the functions and settings options in the user interface	
Knowledge Base	Solutions for common problems during connection, configuration and operation	<a href="http://en.avm.de/service">en.avm.de/service</a>



Medium	Contents	Location
Social media	The latest about the FRITZ!Box and your FRITZ!Box home network	<a href="#">Facebook</a>
		<a href="#">Instagram</a>
		<a href="#">Twitter</a>
		<a href="#">YouTube</a>

---

## Symbols Used

### Symbols used

The following symbols are used in this manual:

Icon	Meaning
	Important message that should be complied with in order to prevent material damage, errors or malfunctions
	Useful tip for configuring and operating the FRITZ!Box

## Device Data on the Type Label

### Overview

Important device data on your FRITZ!Box, such as the preconfigured network key, the FRITZ!Box password and the serial number, are presented on the type label on the bottom of the housing. The network key is required in order to safely connect computers and other devices with the FRITZ!Box. The FRITZ!Box password is needed to open the user interface. The serial number should be provided when submitting support requests.

### Device Data on the Type Label

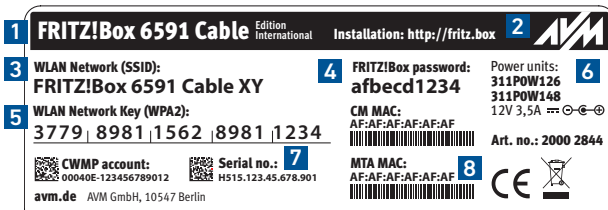

No.	Meaning
1	Product name
2	Address of user interface
3	Name of wireless radio network (SSID)
4	Password of user interface
5	Network key (wireless LAN password)
6	Power adapter specification
7	Serial number
8	Article number

## Package Contents

### Package Contents

No.	Supplied Part	Details
1	FRITZ!Box 6591 Cable	
1	Coaxial cable	Included in the package if you purchased the FRITZ!Box from a retail vendor.  Not included in the package if you received the FRITZ!Box from a cable network provider.
1	Power adapter	white
1	Network cable	also "LAN cable", yellow
1	TAE/RJ11 adapter	black
1	Quick guide	Connecting the FRITZ!Box



# Functions and Structure

Functions .....	18
Connection Sockets .....	21
Buttons .....	23
LEDs .....	24
Requirements for Operation .....	26

## Functions

### Internet Router

The FRITZ!Box 6591 Cable is an internet router for connecting to a cable connection.

### Telephone System

The FRITZ!Box is a telephone system (or PBX: Private Branch Exchange) for internet telephony (IP telephony, VoIP) on IP-based lines.

The following devices can be connected to the FRITZ!Box:

- 6 cordless (DECT) telephones
- 2 analog devices (telephones, answering machines, door inter-coms)
- 8 ISDN telephones or 1 ISDN telephone system
- 10 IP telephones (FRITZ!App Fon, for instance)

Up to five integrated answering machines can be used to save voice messages and, upon request, send them to you by email. Via the integrated fax function you can also send and receive faxes without an external fax machine.

### Wireless Access Point

The FRITZ!Box is a wireless access point for any wireless LAN devices, for instance:

- notebooks
- tablets
- smartphones
- wireless printers

## DECT Base Station

The FRITZ!Box is a DECT base station that supports the DECT ULE standard. The following DECT devices can be operated simultaneously on the FRITZ!Box:

- Up to 6 cordless (DECT) telephones
- Up to 10 FRITZ!DECT 200/210 outlet switches
- Up to 12 FRITZ!DECT 301/300/Comet DECT radiator controls
- up to 10 FRITZ!DECT 400 switches
- up to 10 Smart Home devices via HAN FUN

## Hub in the Home Network

The FRITZ!Box is the hub in the home network. All of the devices connected with the FRITZ!Box make up the home network. With the FRITZ!Box you can keep track of all devices. The functions available for the home network include:

- A media server for transmission of music, pictures and video to playback devices in the home network
- MyFRITZ! makes access to your own FRITZ!Box possible even from the internet
- FRITZ!NAS provides for easy access to all files in the network.

## USB Ports

The FRITZ!Box has two USB 3.0 ports to which you can connect the following devices:

- USB storage devices (for example, flash drives, external hard drives, card readers)
- USB printers, USB all-in-one printers, USB scanners
- USB hubs

## Smart Home

The following Smart Home devices can be registered with the FRITZ!Box at the same time, and configured and controlled via the FRITZ!Box:

Type of Device	Number	Features
<b>Smart plugs</b> <ul style="list-style-type: none"> <li>FRITZ!DECT 200</li> <li>FRITZ!DECT 210</li> </ul>	up to 10	<ul style="list-style-type: none"> <li>Control the power supply to connected devices</li> <li>Measure the power consumption of connected devices</li> </ul>
<b>Radiator controls</b> <ul style="list-style-type: none"> <li>FRITZ!DECT 300</li> <li>FRITZ!DECT 301</li> <li>Comet DECT</li> </ul>	up to 12	<ul style="list-style-type: none"> <li>Control the room temperature automatically and save energy costs</li> </ul>
<b>Button</b> <ul style="list-style-type: none"> <li>FRITZ!DECT 400</li> </ul>	up to 10	<ul style="list-style-type: none"> <li>Switch smart plugs</li> </ul>
<b>Smart Home devices via HAN FUN</b>	up to 10	<ul style="list-style-type: none"> <li>Connecting Smart Home devices from other manufacturers with the FRITZ!Box</li> <li>Switch smart plugs</li> </ul>

## Connection Sockets

### Connector panel

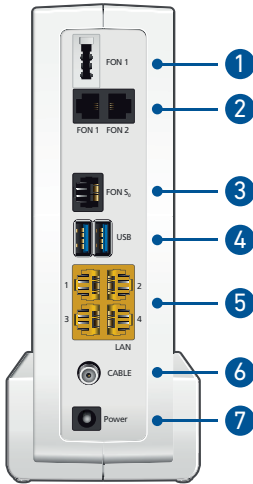

No.	Name	Function
1	FON 1	TAE socket for connecting analog telephones, fax machines, answering machines or a door intercom system
2	FON 1 and FON 2	RJ11 sockets for connecting analog telephones, fax machines, answering machines or a door intercom system
3	FON S <sub>0</sub>	RJ45 port for connecting ISDN telephones and telephone systems (PBXs)
4	USB	USB 3.0 ports for connecting USB devices like printers or storage media

No.	Name	Function
5	LAN 1 to LAN 4	Ports for connecting computers and other network-compatible devices like hubs and game consoles
6	CABLE	Socket for connecting to the cable connection
7	Power	Port for plugging in the power supply

## Buttons

### Button Functions



No.	Button	Function
1	Connect/WPS	<ul style="list-style-type: none"> <li>Register wireless devices with the FRITZ!Box via WPS; <a href="#">see page 41</a></li> <li>Register cordless telephones with the FRITZ!Box; <a href="#">see page 42</a></li> </ul>
2	DECT	Find cordless phones (paging call)

## LEDs

### Meaning of the LEDs

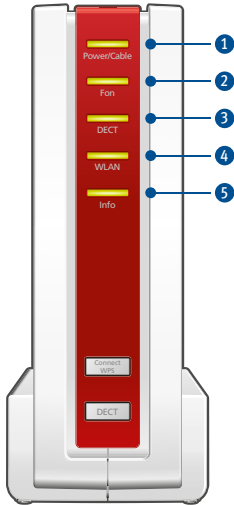

No.	LED	Condition	Meaning
1	Power/ Cable	on	Power supply is connected and the cable connection is ready for operation.
		flashing	Power supply is connected and the cable connection is being established or has been interrupted.
2	FON	on	A telephone connection via the internet is active.
		flashing	Messages in your voice mail/email inbox  This function must be supported by your telephony provider.



No.	LED	Condition	Meaning
3	DECT	on	DECT function is switched on.
		flashing	Registration of a DECT device in progress.
4	WLAN	on	Wireless LAN is switched on.
		flashing	<ul style="list-style-type: none"> <li>Switching wireless LAN function on or off.</li> <li>Applying changes to the wireless LAN settings.</li> <li>WPS in progress: Registration of a wireless device in progress.</li> <li>WPS aborted: more than 1 device is performing WPS with the FRITZ!Box.</li> <li>Repeat the WPS procedure: 1 device per WPS procedure.</li> </ul>
5	Info	lights green	<ul style="list-style-type: none"> <li>AVM Stick &amp; Surf with FRITZ!WLAN USB Stick is concluded.</li> <li>Adjustable; see <a href="#">Selecting Signaling of the "Info" LED, page 181</a>.</li> </ul>
		flashing green	<ul style="list-style-type: none"> <li>FRITZ!OS updating.</li> <li>AVMStick &amp; Surf with FRITZ!WLAN USB Stick in progress.</li> <li>Adjustable; see <a href="#">Selecting Signaling of the "Info" LED, page 181</a>.</li> </ul>
		lights red or flashing red	<p>Error:</p> <ul style="list-style-type: none"> <li>Open the user interface, see <a href="#">page 51</a>.</li> <li>Follow the instructions on the "Overview" page in the user interface.</li> </ul>

## Requirements for Operation

### Requirements

- An internet-ready cable connection
- For an internet connection via mobile network:
  - USB modem with mobile internet access
- Computer with network connection (to establish a connection with the internet connection of the FRITZ!Box via LAN cable)
- Computer, tablet or smartphone with support for wireless LAN (to establish a wireless connection with the internet connection of the FRITZ!Box)
- An up-to-date web browser

For comprehensive technical information about your FRITZ!Box, [see page 260](#).





# Connecting

Overview: Connecting the FRITZ!Box .....	28
Placement.....	29
Connecting to the Internet: Possibilities.....	31
Connecting with the Internet Access: Cable Connection .....	32
Connecting to Electrical Power .....	33
Connecting with the Internet Access: Mobile Network .....	34
Connecting a Computer with a Network .....	36
Connecting the Computer via Wireless LAN .....	38
Connecting Telephones .....	42
Connecting Smartphones .....	47
Connecting a Door Intercom System .....	49

## Overview: Connecting the FRITZ!Box

### Overview

Connecting the FRITZ!Box entails the following steps:

	Instructions
	Place or hang up the FRITZ!Box in a suitable location.
	Connect the FRITZ!Box to the cable junction.
	Connect the FRITZ!Box to the power supply.
	Connect your computers and network devices to the FRITZ!Box.
	Connect your telephones to the FRITZ!Box.

## Placement

### Rules for Setting Up the FRITZ!Box

- Only use the FRITZ!Box indoors.
- Position the FRITZ!Box near an electrical outlet that is easy to reach, so that you can unplug the FRITZ!Box at any time.
- Position the FRITZ!Box in a dry location that is free of dust.
- Do not place the FRITZ!Box on heat-sensitive surfaces like furniture with sensitive paintwork.
- To avoid heat accumulation, the FRITZ!Box should not be placed on carpets or upholstered furniture.
- Provide for sufficient air circulation around the FRITZ!Box and do not cover up the FRITZ!Box. The ventilation slits must never be obstructed.

### Rules for Optimum Wireless LAN Reception

Radio wave propagation during wireless LAN operation is strongly dependent on the positioning of your FRITZ!Box: Keep the following rules in mind for good reception:

- Position the FRITZ!Box in a central location.
- Position the FRITZ!Box in an elevated location.
- Keep sufficient distance from potential sources of interference like DECT base stations, microwave devices or electric devices with large metal housings.
- Position the FRITZ!Box so that it is not covered by other objects and there are as few obstacles as possible between it and the other wireless devices.



By slightly shifting the position of the FRITZ!Box it is often possible to improve the wireless connection significantly. If reception is still unsatisfactory, note our recommendations: [see Extending Wireless LAN Range, page 63.](#)

## Instructions: FRITZ!Box Placement

1. In compliance with the rules mentioned above, select a suitable location for the FRITZ!Box.
2. Place the FRITZ!Box in this location.

## Connecting to the Internet: Possibilities

### Overview

The FRITZ!Box is an internet router for connecting for the cable connection.

Type of Connection	Line Type
Cable connection	the "CABLE" socket directly to the cable junction

The FRITZ!Box can also connect to the Internet via the mobile communications network:

Type of Connection	Line Type
Mobile	the USB broadband dongle (UMTS/HSPA/LTE)

## Connecting with the Internet Access: Cable Connection

### Overview

Your FRITZ!Box is designed to connect directly with the cable junction.

### Requirements

To connect the FRITZ!Box you need a coaxial cable. You receive the coaxial cable from your cable network operator.

### Instructions: Installation on the Cable Junction

1. Insert one end of the coaxial cable into the port on your FRITZ!Box labeled "CABLE".
2. Insert the other end of the coaxial cable into the multimedia outlet of your cable junction.

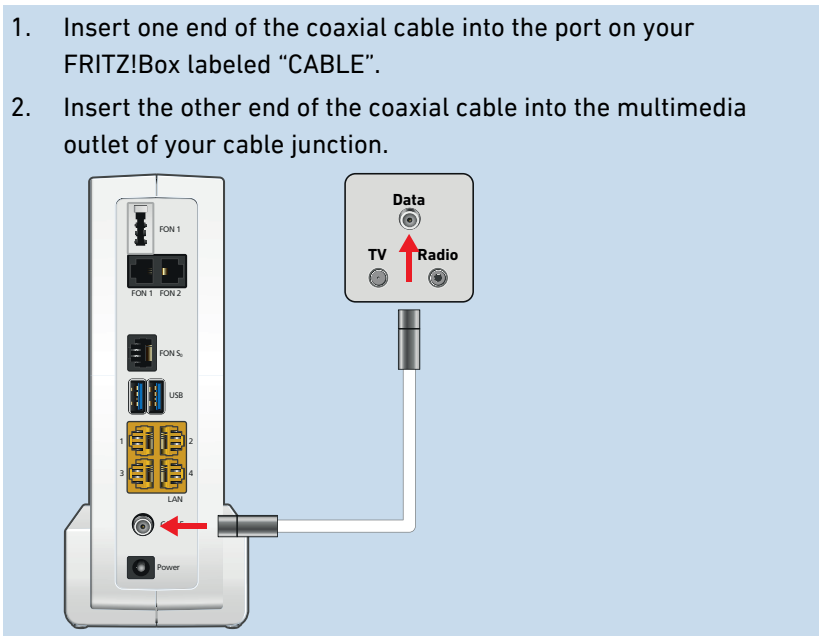



## Connecting to Electrical Power

### Overview

Connect the FRITZ!Box to the power supply.

### Rules

- Avoid using socket strips and extension cords if at all possible.
- If it is not possible to avoid using socket strips and extension cords, then do not connect multiple extension cords or socket strips to each other.
- Use only the power adapter included with delivery.

### Instructions: Plugging in to electrical power

1. Remove the power adapter from the FRITZ!Box package.
2. Connect the power adapter to the socket on the labeled "Power".

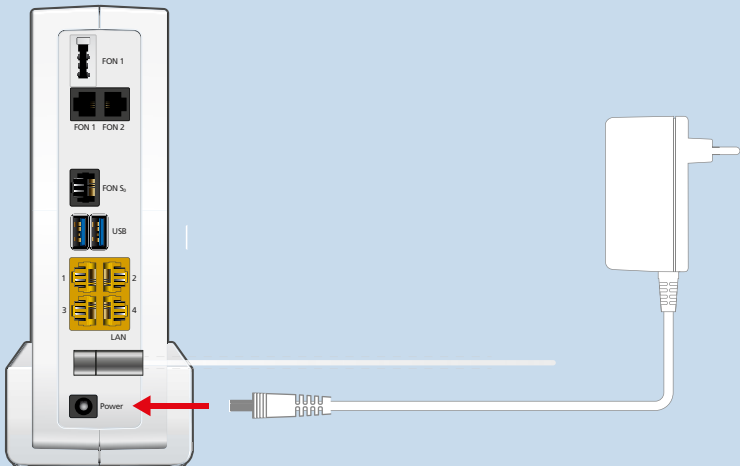

3. Plug the other end into a power outlet.  
The "Power/Cable" LED begins flashing after a few seconds to indicate that the FRITZ!Box is ready for operation.

---

## Connecting with the Internet Access: Mobile Network

### Overview

The FRITZ!Box can connect to the internet via the mobile communications network.

### Supported Devices and Mobile Communications Standards

The FRITZ!Box supports the following devices and mobile communications standards:

- USB mobile communications dongles for LTE/UMTS/HSPA
- Mobile communications dongles and smartphones that support USB tethering

### Requirements

You need the following:

- a mobile communications device for internet access via LTE, UMTS or HSPA
- a SIM card from a mobile communications network provider

### Restrictions by the Mobile Communications Network Provider



Due to technical limitations on the part of the mobile communications network providers, some limitations may arise for internet telephone calls and for applications requiring an incoming connection. This is also true for using port sharing, releasing USB storage media for sharing, remote maintenance over HTTPS, Dynamic DNS and VPN. Contact your network provider for details on any restrictions that may apply.

## Example Configuration

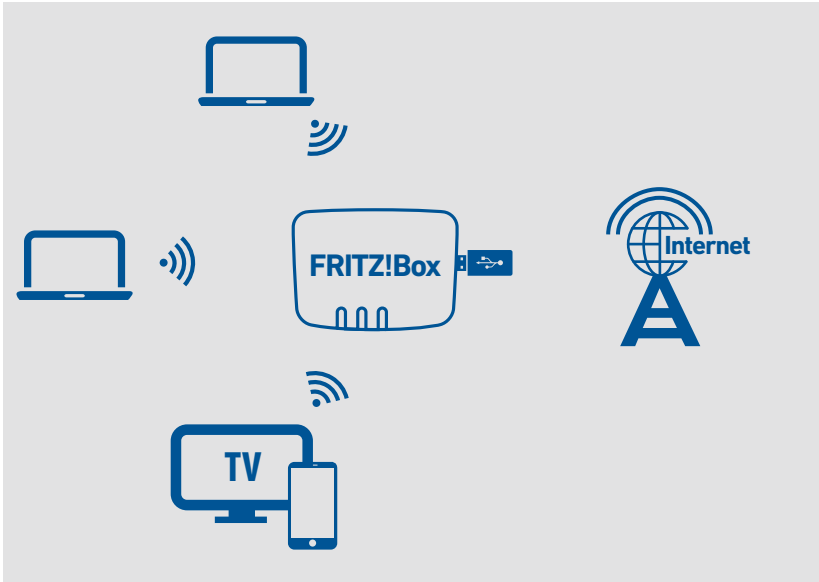

### Instructions: Connecting the Mobile Broadband Dongle

1. Insert the mobile broadband dongle in a USB port of the FRITZ!Box.

### Instructions: Connecting with the Smartphone via USB

1. Connect the smartphone to a USB port on the FRITZ!Box using a USB cable.

## Connecting a Computer with a Network

### Overview

You can connect computers and other network devices with the FRITZ!Box using a network cable. This is recommended especially for the initial configuration of your FRITZ!Box. The way a computer is connected to the FRITZ!Box is the same regardless of the operating system on the computer. Open the user interface of the FRITZ!Box in an up-to-date web browser ([see page 51](#)).

### Rules

- The network cable used to connect the computer and other network devices to the FRITZ!Box must be a maximum of 100 m in length.

### Instructions: Connecting the Computer Using a Network Cable

1. Insert the network cable into the network (LAN) port of the computer.
2. Insert the free end of the cable into a LAN port on the FRITZ!Box.

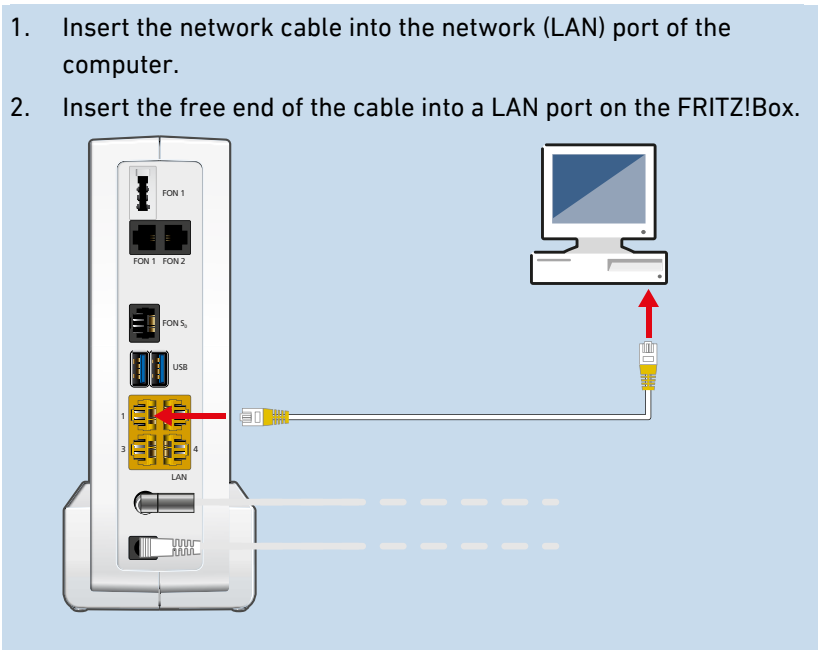

## Instructions: Connecting a Network Hub or Network Switch

You can connect a network hub or network switch to the FRITZ!Box.

1. Insert the network cable included in the package into the uplink port of the network hub or network switch.
2. Insert the free end of the cable into a LAN port on the FRITZ!Box.

## Connecting the Computer via Wireless LAN

### Overview

You can connect computers and other network devices to the FRITZ!Box without cables via wireless LAN.

### Secure Wireless Connections

Wireless connections can be secured using encryption. Two things are required for encryption:

- an encryption technique
- a key

An encryption technique and a network key are preconfigured in the FRITZ!Box. A network device that would like to connect with the FRITZ!Box must register with the FRITZ!Box using the network key.

The network key can be made known to a network device in the following ways:

- by entering the network key manually
- by transmitting the network key via WPS

As soon as the network key is known, a secure wireless connection is established.

## Encryption

WPA encryption with WPA2 mode is preconfigured in the FRITZ!Box. WPA2 mode is more secure than the older WPA mode.

The more up to date the encryption mode, the more secure the wireless connection:

Encryption	Mode	Protocol	Security
WPA	WPA2	CCMP	Very secure
	WPA	TKIP	Secure
non-encrypted	–	–	Very insecure, not recommended

The encryption method and mode must be supported by the network devices. Set the encryption mode in the FRITZ!Box according to the following table:

Mode	Use
WPA2	This mode is preconfigured in the FRITZ!Box. This mode is suitable if you use only network devices that support WPA2. Most up-to-date wireless devices support this mode.
WPA + WPA2	Set this mode if you would also like to use older network devices that do not support WPA2. With this setting the FRITZ!Box automatically uses the WPA mode most suitable for your connections.

Network devices that do not support WPA can establish only non-encrypted wireless connections to the FRITZ!Box. You should avoid using such devices if at all possible. You should avoid using such devices if at all possible.

Comprehensive information about how to protect your FRITZ!Box and the wireless network from access by strangers is presented in the internet at:

[en.avm.de/guide/security](http://en.avm.de/guide/security)

## Requirements

Wireless LAN must be enabled in the FRITZ!Box. Wireless LAN is enabled when the “WLAN” LED is lit up.

## Instructions: Entering the Network Key Manually

1. Start the wireless LAN software on your wireless device.
2. Search for wireless networks in the environment (see the documentation of your wireless device) and select the wireless network of the FRITZ!Box.

The preconfigured name of the FRITZ!Box's wireless network is composed of “FRITZ!Box 6591 Cable” and two random letters (for instance, “FRITZ!Box 6591 Cable XY”), and is printed on the type label on the bottom of the housing.

3. Click “Connect”.
4. Enter the network key of the FRITZ!Box. The network key is printed on the bottom of the housing of the FRITZ!Box; [see Device Data on the Type Label, page 15](#).

The wireless LAN connection will be established.



## Instructions: Transferring the network key using WPS

With WPS (Wi-Fi Protected Setup) you can connect a wireless device with the FRITZ!Box quickly and easily without entering the network key of your FRITZ!Box. This key is transmitted to the wireless device automatically.

1. Start the wireless LAN software on your wireless device.
2. Search for wireless networks in the environment on the wireless device (see the documentation of your wireless device) and select the wireless network of the FRITZ!Box.

The preconfigured name of the FRITZ!Box's wireless network is composed of "FRITZ!Box 6591 Cable" and two random letters (for instance, "FRITZ!Box 6591 Cable XY"). The name is printed on the type label on the bottom of the housing.

3. Start the connection procedure via WPS (see the documentation of your wireless device).
4. On the FRITZ!Box: Press the "Connect/WPS" button briefly.

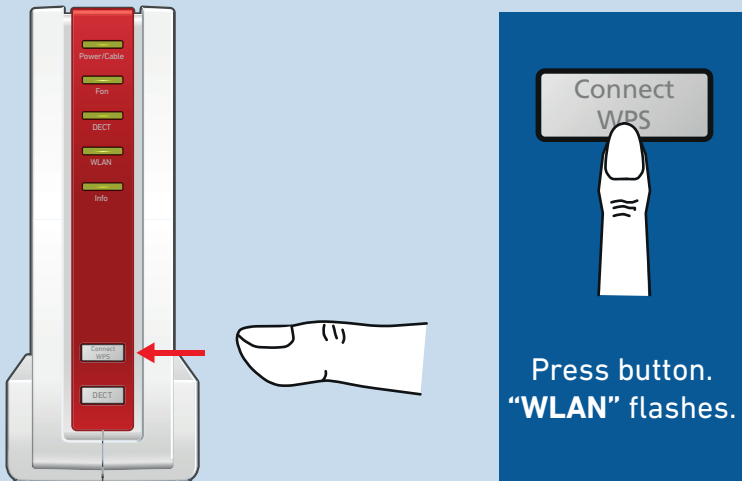

The "WLAN" and "DECT" LEDs on the FRITZ!Box flash and the wireless connection is established.

## Connecting Telephones

### Overview

You can connect telephones, fax machines, answering machines, and telephone systems to your FRITZ!Box.

Up to six cordless telephones like FRITZ!Fon can be registered with the integrated DECT base station.



During a power outage you cannot make any telephone calls with the connected telephones.

### Instructions: Registering a Cordless Telephone

1. On a cordless telephone: Start registration with a base station.
2. On the FRITZ!Box: Press the "Connect/WPS" button.

The "DECT" LED flashes.

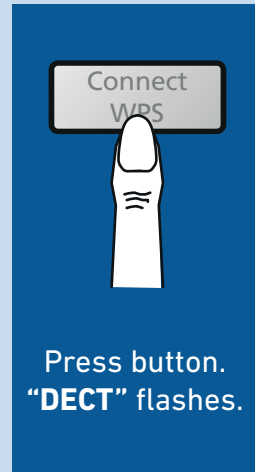
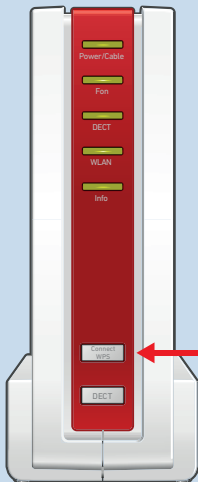

3. On a cordless telephone: Enter the PIN of the FRITZ!Box on the telephone (preset value: 0000).
4. In the user interface of your FRITZ!Box: Configure the telephone; see [Configuring Telephones, page 67](#).

## Instructions: Connecting an Analog Telephone

1. Connect the telephone, the answering machine or the fax machine to a "FON 1" port. The other "FON 1" port has to remain free.

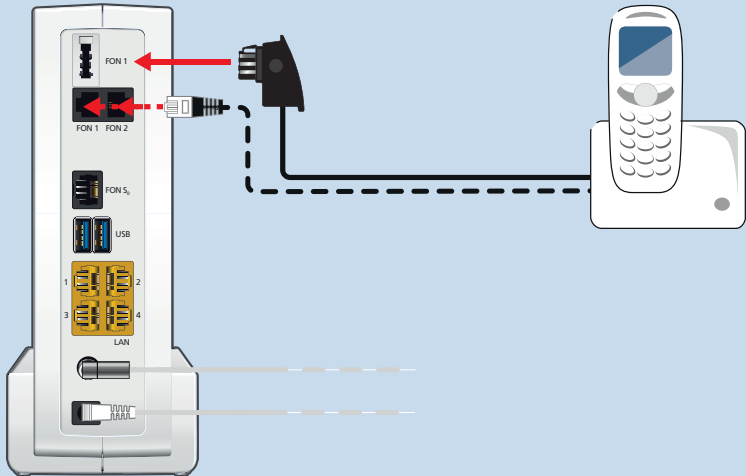

2. In the user interface of your FRITZ!Box: Configure the connected device; see [Configuring Telephones](#), page 67.

## Instructions: Connecting a Second Analog Telephone

1. Connect the telephone, the answering machine or the fax machine to the "FON 2" port. If the device to be connected has a TAE connector, use the TAE/RJ11 adapter included with delivery.

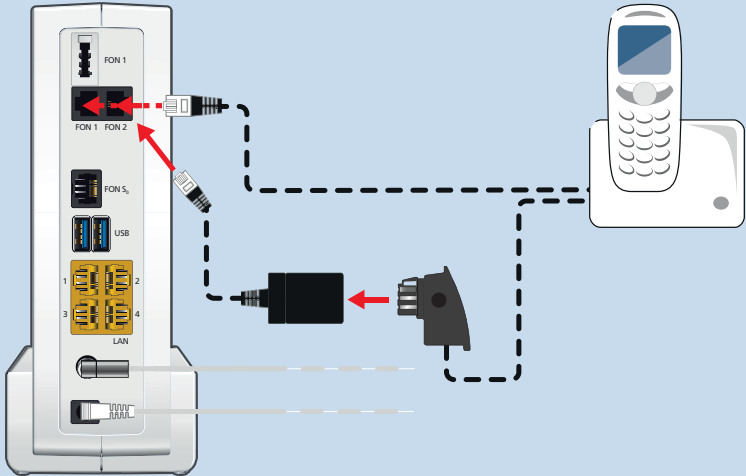

2. In the user interface of your FRITZ!Box: Configure the connected device; see [Configuring Telephones](#), page 67.

## Instructions: Connecting an ISDN Telephone

1. Connect the telephone to the “FON S<sub>0</sub>” port.

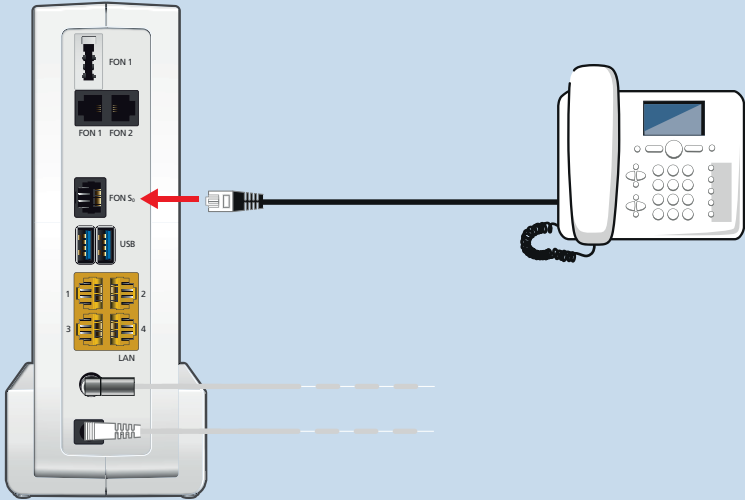

2. In the user interface of your FRITZ!Box: Configure the telephone; see [Configuring Telephones, page 67](#).

## Connecting Multiple ISDN Devices

You can connect up to eight ISDN devices to the FRITZ!Box. The FRITZ!Box can provide power to one ISDN device, but the other ISDN devices must use their own power supply. Multiple ISDN devices can be connected in the following ways:

- with an ISDN distributor (available from vendors)
- by having a technician install a S<sub>0</sub> bus, which is connected to the “FON S<sub>0</sub>” port. Note for the technician: The “FON S<sub>0</sub>” port is terminated. Two terminating resistors are included in the FRITZ!Box.

## Instructions: Connecting an IP Telephone

IP telephones are special telephones for internet telephony (IP stands for Internet Protocol).

1. Connect the IP telephone to the FRITZ!Box using a LAN cable or wireless LAN.
2. In the user interface of your FRITZ!Box: Configure the telephone; see [Configuring Telephones, page 67](#).

## Connecting Smartphones

### Overview

Your iPhone or Android smartphone can be registered with the FRITZ!Box via wireless LAN using the FRITZ!App Fon. Then you can use the smartphone to make calls to the numbers configured in your FRITZ!Box whenever you are home. Advantage: No mobile communication charges will be incurred for outgoing calls, and you can also take calls to your home telephone line on your smartphone. The smartphone can still be reached at your mobile telephone number.

### Requirements

- iPhone or Android smartphone
- The setting “Allow access for applications” is enabled in the FRITZ!Box (in the user interface under “Home Network / Home Network Overview / Network Settings”)

### Instructions: Connecting a smartphone

1. Establish a wireless LAN connection to the FRITZ!Box on your smartphone.
2. Install FRITZ!App Fon on your smartphone. FRITZ!App Fon is available from the Google Play Store and the Apple App Store.
3. Start the FRITZ!App Fon.  
FRITZ!App Fon is automatically configured as an IP telephone in the FRITZ!Box.
4. In the user interface of your FRITZ!Box: Configure the IP telephone “FRITZ!App Fon”; see [Configuring Telephones, page 67](#).

### Connection Status of FRITZ!App Fon

The icon in the FRITZ!App Fon title bar shows the state of the connection with the FRITZ!Box.

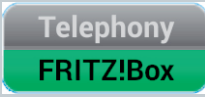
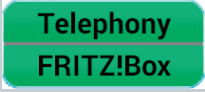
Icon	Meaning
	Wireless connection to the FRITZ!Box is active.
	You can make calls via the FRITZ!Box with your smartphone.



## Connecting a Door Intercom System

### Overview

Door intercom systems with an a/b interface and IP door intercoms can be connected to the FRITZ!Box. Then you have the following options:

- You can answer the doorbell on your telephones, speak with visitors, and open the door, even on a mobile telephone or other telephone connection away from home.
- You can view the camera image from your door intercom system on FRITZ!Fon telephones with a color display.
- You can configure a special ring tone to signal the doorbell on a FRITZ!Fon.

### Supported Door Intercom Systems

- Door intercom system with an a/b interface that uses DTMF tone dialing
- IP door intercom systems that can be configured as SIP clients (by entering the login data for a SIP registrar)

### Instructions: Connecting an IP Door Intercom System

1. Connect the IP door intercom system to the FRITZ!Box using a LAN cable or wireless LAN.
2. In the user interface of your FRITZ!Box: Configure the door intercom system; see [Configuring a Door Intercom System](#), page 69.

# User Interface

Opening the User Interface .....	51
Using the Wizard for Basic Configuration .....	54
Logging Out of the User Interface .....	56
Using the Standard View and Advanced View.....	58

## Opening the User Interface

### Overview

The FRITZ!Box has a user interface you can open in a web browser on your computer or on mobile devices like a tablet or smartphone. In the user interface you configure the FRITZ!Box, enable or disable functions, and receive information on connections, interfaces, and on the entire home network. You can also configure whether and how you would like to use the AVM services for diagnostics and maintenance of your FRITZ!Box.

### Requirements

- Your computer, tablet or smartphone is connected with the FRITZ!Box by wireless LAN or with the network cable.

### Instructions: Opening the User Interface

1. Start a web browser on your computer or mobile device and enter <http://fritz.box> in the address bar.

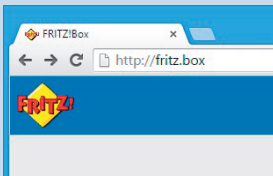

2. Enter the preset FRITZ!Box password and click “Log In”.  
The preset password is printed on the type label on the bottom of the housing and on the FRITZ!Notes service card.

The FRITZ!Box user interface opens.

## Areas of the User Interface

The following figure shows you the different areas of the user interface:

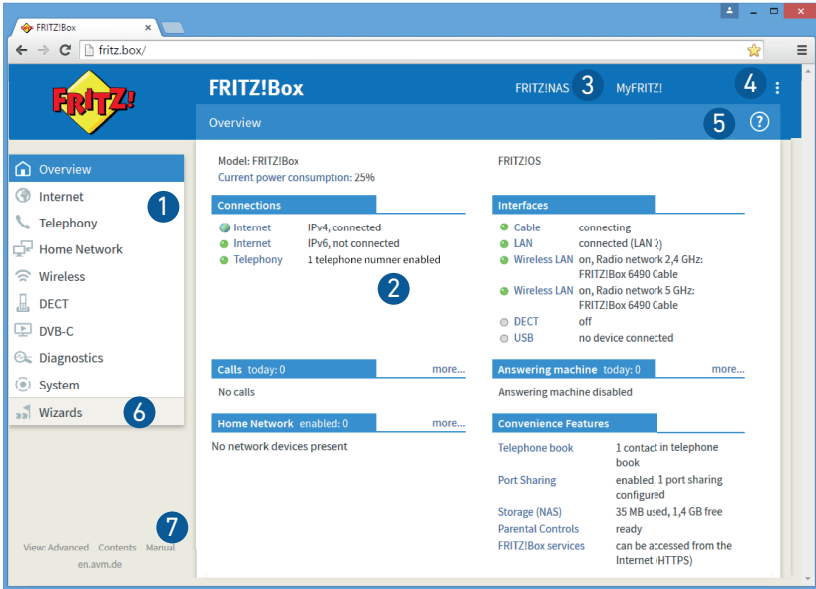

No.	Display / Function
1	The FRITZ!Box user interface menu
2	Functions and settings for the given menu command
3	Links to the MyFRITZ! and FRITZ!NAS areas
4	3 vertical dots menu <ul style="list-style-type: none"> <li>Log off the user interface</li> <li>Change password</li> <li>Switch between standard and advanced view</li> <li>Links to the MyFRITZ! and FRITZ!NAS areas</li> </ul>
5	Question mark symbol for opening the online help

No.	Display / Function
6	Wizards for configuration of the FRITZ!Box
7	<b>Related links</b> <ul style="list-style-type: none"><li>• View: Switching between standard and advanced view</li><li>• Contents: Overview of all pages in the user interface</li><li>• Manual: FRITZ!Box 6591 Cable (PDF)</li><li>• Tips &amp; Tricks: Link to the FRITZ!Box Knowledge Base</li><li>• en.avm.de: AVM web pages</li></ul>

## Using the Wizard for Basic Configuration

### Overview

The first time the user interface is opened, the Wizard for Basic Configuration of the FRITZ!Box is started. This wizard assists you in entering your account information to connect to the internet and use your telephones.

### Requirements

- The FRITZ!Box password has been supplied. The preset password is printed on the type label on the bottom of the housing.
- The account information has been supplied by your internet service provider.
- The telephone numbers have been supplied by your telephony provider.

### Instructions: Using the Wizard for Basic Configuration

To protect your private data, settings and account information, the wizard starts by prompting you to assign a password for access to the user interface.

You can also choose whether you would like to use the AVM services for diagnostics and maintenance of your FRITZ!Box; [see Using AVM Services for Diagnostics and Maintenance, page 88](#).

1. Enter the preset FRITZ!Box password and click “Log In”. The preset password is printed on the type label on the bottom of the housing.
2. Choose whether you would like to use the AVM services for diagnostics and maintenance. We recommend leaving this option enabled. You can change the setting later at any time.

3. Click "Next."
4. Follow the wizard's instructions.

Once the wizard is complete, the basic configuration of the FRITZ!Box has been concluded. Once the wizard is complete, the basic configuration of the FRITZ!Box has been concluded.



The wizard can be restarted at any time via the FRITZ!Box user interface.

## Logging Out of the User Interface

### Overview

Session IDs are assigned for access to the FRITZ!Box user interface. The use of session IDs offers effective protection from attacks from the internet in which attackers send unauthorized data to a web application. For security reasons, we therefore recommend that you log out of the user interface before surfing the web.



Use push services to have yourself notified each time someone logs into or out of your FRITZ!Box; see [Configuring Push Services, page 179](#).

### Automatic Logout when Idle

If you have not logged out of the FRITZ!Box user interface, and have not been active in the browser for 20 minutes, you will be logged out automatically. You must log in again to regain access to the FRITZ!Box user interface.



## Instructions: Manual Logout

1. Click the menu with the three dots (1) in the header of the FRITZ!Box user interface:



2. Click "Log Off" (2) in the menu.

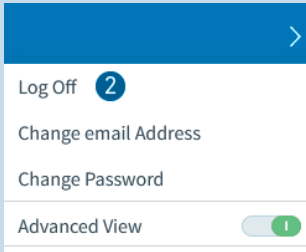

You have logged out of the FRITZ!Box user interface.

## Using the Standard View and Advanced View

### Overview

The FRITZ!Box user interface offers two views: the standard view and the advanced view.

The standard view of the FRITZ!Box user interface includes all settings and functions that are needed for normal operation of the FRITZ!Box.

In the advanced view, additional settings options are offered for advanced users. These settings are not required for everyday operation of the FRITZ!Box.

### Instructions: Switching between the Views



You should only use the advanced view of the “Internet” and “Home Network” menus if you have advanced network expertise. Combining various settings in these menus can produce a situation in which the user interface of the FRITZ!Box can no longer be opened.

1. Click in the area to the left under the menu on “View” (1) to switch back and forth between the “Standard” and “Advanced” views.

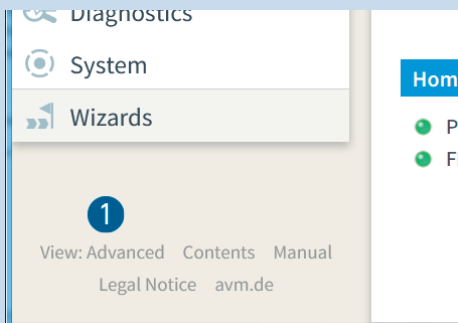



# Configuring

Overview: Configuring the FRITZ!Box.....	60
Configuring Internet Access via the Cable Connection .....	61
Setting Up Internet Access via the Mobile Network .....	62
Extending Wireless LAN Range .....	63
Expanding a Wireless Radio Network .....	64
Configuring Your Telephone Numbers .....	66
Configuring Telephones .....	67
Configuring a Door Intercom System .....	69
Saving Power with the FRITZ!Box.....	70

## Overview: Configuring the FRITZ!Box

### Overview

Configuration of the FRITZ!Box entails the following steps:

Instructions	
	Configure the internet connection in the FRITZ!Box.
	Set up the connected telephones and their telephone numbers in the FRITZ!Box.
	Configure your smartphone in the FRITZ!Box (optional).

### Requirements

- The FRITZ!Box is connected with the internet access.
- You have connected all of the telephones you want to use with the FRITZ!Box.

## Configuring Internet Access via the Cable Connection

### Overview

The internet connection for the cable connection has to be configured once in the FRITZ!Box, then it is always available. The first time you open the FRITZ!Box user interface, you will automatically be prompted to configure the internet connection.

### Requirements

The FRITZ!Box is connected to the cable connection.

### Configuring Your Internet Connection Automatically

If you received the FRITZ!Box 6591 Cable from your cable provider, the internet connection will be configured automatically. You can skip the instructions below.

### Instructions: Configuring Internet Access

1. Open the user interface, [see page 51](#).
2. If the wizard does not start automatically, select the “Wizards” menu.
3. Click the “Configure Internet Connection” Wizard and follow the instructions.
4. Open a new tab in your web browser and enter a web address, for instance [en.avm.de](http://en.avm.de).  
The requested internet page is displayed.

---

## Setting Up Internet Access via the Mobile Network

### Overview

In the FRITZ!Box you can configure internet access via the mobile network.

### Requirements

- A mobile broadband dongle or a smartphone with USB tethering enabled must be connected to the USB port of the FRITZ!Box; see [Connecting with the Internet Access: Mobile Network, page 34](#).

### Instructions: Setting Up Internet Access via the Mobile Telephone Network

1. Open the user interface, see [page 51](#).
2. Select "Internet / Mobile Communications".
3. For instructions, open the online help .

## Extending Wireless LAN Range

### Overview

In large apartments or houses the wireless LAN radio signal does not always reach into every corner. However, you can generally extend the range of your wireless network by placing your FRITZ!Box at a better location.

### Extending the Wireless LAN Range by Optimizing the Location

When selecting the location of your FRITZ!Box, consider the following conditions. They will have a positive influence on the extension of your FRITZ!Box's wireless radio signal:

- Place the FRITZ!Box in a room located centrally.
- Place the FRITZ!Box on an elevated surface.
- Place the FRITZ!Box in an unobstructed location, and not, for instance, in a cabinet or behind a large object.
- Account for structural conditions such as thick concrete walls or ceilings.
- Eliminate sources of interference in the vicinity of your wireless radio network, for instance, microwaves, refrigerators or baby monitors.
- Make sure that the FRITZ!Box uses frequency ranges that are used by as few other devices as possible. To do this, open the FRITZ!Box user interface and select the "Wireless / Radio Channel" menu.

If these measures are not sufficient, then you can extend the range of your wireless radio network with a wireless repeater; [see Expanding a Wireless Radio Network, page 64](#).

## Expanding a Wireless Radio Network

### Overview

If the FRITZ!Box is placed in a favorable location, but the WiFi signal still does not reach all of your rooms, then you can extend the range of your wireless radio network with a wireless repeater, a powerline device with WiFi function, or with an additional FRITZ!Box. In combination with the FRITZ!Box, FRITZ! devices are especially suitable.

### Example Configuration: Using a FRITZ!WLAN Repeater

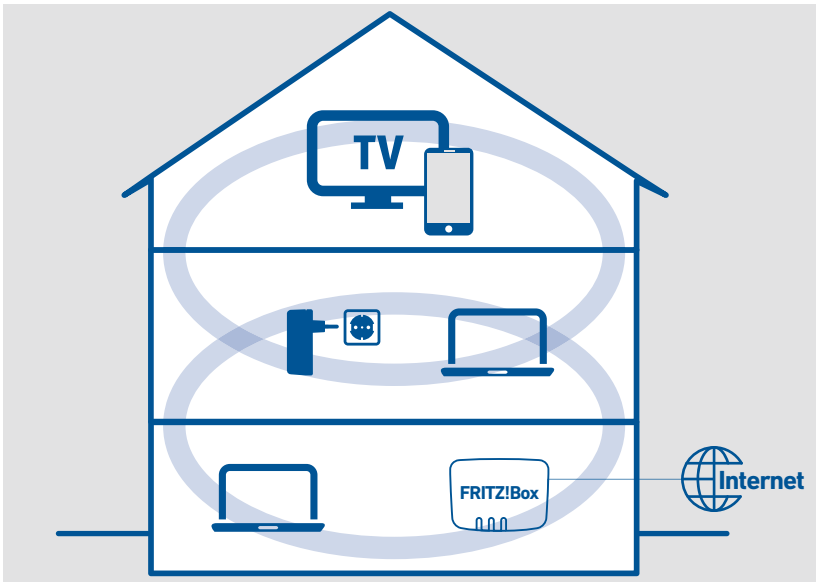

### How a Wireless Repeater Works

With a wireless repeater you extend the range of your wireless radio network. The wireless repeater is connected to the wireless radio network of the FRITZ!Box and to make a further wireless network available, via which wireless devices like smartphones, tablets or game consoles can connect with your home network. The WiFi signal



of the FRITZ!Box is not amplified by a wireless repeater, but merely repeated.

To extend the wireless radio network of your FRITZ!Box you can use FRITZ! devices and wireless repeaters from other manufacturers. You can also deploy multiple wireless repeaters. The wireless repeaters are connected either directly with the wireless router, to increase the range in different directions; or with each other (wireless cascading), to increase the range in a particular direction.

### Extending the Wireless Network with a FRITZ! Device

If you use FRITZ! devices like the FRITZ!WLAN Repeater and FRITZ!Powerline with WiFi function to expand your wireless radio network, then you can integrate these devices in the Mesh of the FRITZ!Box. In the FRITZ!Box Mesh, all individual radio networks are woven together into one big wireless network with increased range and more stable data communication.

FRITZ! Device	Instructions
Extending the Wireless Network with a FRITZ!WLAN Repeater	<a href="#">see page 76</a>
Extending the Wireless Network with FRITZ!Powerline with WiFi Function	<a href="#">see page 78</a>
Extending the Wireless Network with an Additional FRITZ!Box	<a href="#">see page 80</a>

## Configuring Your Telephone Numbers

### Overview

Configure all telephone numbers in the FRITZ!Box that are not configured automatically.

Some telephony providers configure your telephone numbers automatically. This configuration starts either right after the FRITZ!Box is connected to the internet or after the FRITZ!Box user interface is opened.

### Instructions: Configuring Your Own Telephone Numbers

1. Open the user interface, [see page 51](#).
2. Select “Wizards / Manage Telephone Numbers”.
3. Click “Add Telephone Number” and follow the wizard’s instructions.

## Configuring Telephones

### Overview

Once you have connected your telephones, answering machines and fax machines to the FRITZ!Box, configure these devices in the FRITZ!Box. For each device, specify:

- Telephone number for outgoing calls to the public telephone network
- How incoming calls should be handled: Should the device ring (telephone) or pick up (fax machine, answering machine) for every call, or only respond to calls for certain telephone numbers?
- Internal name of the device to be displayed in the call list of the FRITZ!Box
- Further settings that depend on the kind of device. For analog and DECT telephones, for instance, you can enable the “call waiting” function.

### Requirements

- Your own telephone numbers are set up in the FRITZ!Box (see the previous section).

### Instructions: Configuring Telephones and Other Devices

1. Open the user interface, [see page 51](#).
2. Select “Telephony / Telephony Devices”.

3. If the device to be configured is not yet included in the list of telephony devices, click "Configure New Device". Follow the wizard's instructions.

The wizard guides you through the assignment of telephone numbers and enters the device in the list.

4. To configure further settings for a device in the list, click the "Edit" button of the device .

The kind of device determines which additional settings are available.

## Configuring a Door Intercom System

### Overview

Once you have connected your door intercom system to the FRITZ!Box, configure the door intercom system in the FRITZ!Box. Specify the telephones or telephone numbers to which door calls should be forwarded. You can also configure other settings, for instance, to have the camera image sent from the door intercom system to your FRITZ!Fon.

### Requirements

- Your telephones are configured in the FRITZ!Box (see previous section).

### Instructions: Configuring a Door Intercom System

1. Open the user interface, [see page 51](#).
2. Select “Telephony / Telephony Devices”.
3. Click “Configure New Device”. With the “Edit” button  you can also change the settings of a door intercom system that has already been configured.

## Saving Power with the FRITZ!Box

### Overview

The FRITZ!Box offers various settings for energy-saving operation. The following section describes how you can configure these settings and what potential energy savings can be expected.

### Viewing Information on Energy Consumption

The current power consumption of the total FRITZ!Box system is displayed on the “Overview” page of the user interface.

Information on the power consumption of the individual areas, and on the average power consumption over the last 24 hours, is presented in the FRITZ!Box user interface under “System / Energy Monitor / Energy Consumption”.

### Using Savings Potential

What	How	Where
Wireless	configure a schedule; <a href="#">see page 157</a>	“Wireless / Schedule” menu
	Switch off wireless LAN, <a href="#">see page 157</a>	• “Wireless / Radio Network” menu
	Reduce the maximum transmitter power	“Wireless / Radio Channel / Radio Channel Settings / Adjust Radio Channel Settings” menu
LAN	Use the LAN port in energy-saving (Green) mode	“Home Network / Network / Network Settings / LAN Settings” menu

What	How	Where
USB	Use the USB port in energy-saving (Green) mode, <a href="#">see page 148</a>	“Home Network / USB Devices / USB Settings”

## Saving Power with Smart Home

With intelligent Smart Home devices like FRITZ!DECT, electrical appliances are integrated into the home network. This way they can be switched on and off by schedule. At the same time, they inform the FRITZ!Box about consumption, energy costs incurred, and the CO2 footprint.

### Instructions: Configuring a Schedule for Electrical Appliances in the Home Network

1. Open the user interface, [see page 51](#).
2. Select “Home Network / Smart Home”.
3. For instructions, open the online help .

## Mesh with FRITZ!

Mesh in the Home Network of the FRITZ!Box .....	73
Updating the FRITZ!Box for Mesh .....	75
Integrating FRITZ!WLAN Repeater into the FRITZ!Box Mesh .....	76
Integrating FRITZ!Powerline into the Mesh of the FRITZ!Box .....	78
Deploying an Additional FRITZ!Box as a Mesh Repeater.....	80
Using Telephony in the Mesh .....	81



## Mesh in the Home Network of the FRITZ!Box

### Overview

Mesh is a networking concept that combines the individual wireless radio networks of your FRITZ! devices in the FRITZ!Box home network into a single powerful wireless radio network. Mesh requires FRITZ!OS version 7.00 or higher.



Only FRITZ! devices can be integrated into the FRITZ!Box Mesh. Devices from other manufacturers can be integrated into the FRITZ!Box home network, but not into the FRITZ!Box Mesh.

### How Mesh Works

A Mesh always has a FRITZ!Box at its center. This central FRITZ!Box is the Mesh Master. Other FRITZ! devices like FRITZ!WLAN Repeaters, FRITZ!Powerline devices or other FRITZ!Box products adopt the settings of the Mesh Master – the first time they are configured, and every time these settings change. The FRITZ! devices also constitute wireless access points in the Mesh, where they thus function as Mesh Repeaters.

The FRITZ! devices in a Mesh coordinate with each other. For instance, all devices automatically use the best connection signal in order to achieve the fastest possible data transmission.

## Benefits of Mesh

Combining all wireless radio networks into one big wireless radio network brings many benefits to the FRITZ!Box home network:

- **Shared settings**

As Mesh Master, the FRITZ!Box transfers all wireless LAN settings to the Mesh Repeaters: wireless network name (SSID), network key, wireless guest access and wireless schedule. This way you only have to set up a single wireless connection on your smart-phones, tablets, and notebooks to gain access to the home network and the FRITZ!Box's internet connection.

Settings for push services, automatic updates and AVM services are also shared in the Mesh.

- **Central home network overview**

The Mesh Overview in the FRITZ!Box user interface shows you which devices in the home and guest network are active, how they are connected with each other, and which throughput rates are available over the individual connections.

You can check in the Mesh Overview whether any updates are available for FRITZ! devices. Updates can be started directly in the Mesh Overview.

- **Powerful WiFi**

Mesh enables improved information exchange among the FRITZ! devices and thus provides for faster and more stable wireless connections. Better ranges are achieved by using the access points distributed through the Mesh.

## Updating the FRITZ!Box for Mesh

### Overview

In order to be able to use Mesh in the home network, your FRITZ!Box must have FRITZ!OS version 7.00 or higher. We recommend updating to the latest version of FRITZ!OS.



If you have an older FRITZ!Box which can no longer be updated to FRITZ!OS version 7.00 or higher, then you cannot use this FRITZ!Box for Mesh.



If you received your FRITZ!Box from your cable provider, then you FRITZ!OS updates will be installed automatically by your provider. The features and wizards for updates are not available in the FRITZ!Box user interface.

### Updating Instructions: FRITZ!Box

1. Open the user interface, [see page 51](#).
2. Click on “Update” in the “System” menu.
3. Click the “Find New FRITZ!OS” button.
4. Click on the “Start Update Now” button.

Updating FRITZ!OS. The FRITZ!Box is now ready for Mesh.

## Integrating FRITZ!WLAN Repeater into the FRITZ!Box Mesh

### Overview

To expand your wireless radio network, you can integrate a FRITZ!WLAN Repeater into the Mesh of the FRITZ!Box. Mesh connects the individual wireless networks of your FRITZ! devices to form a combined wireless network.

### Requirements

The FRITZ!WLAN Repeater is located in the home network of a FRITZ!Box with FRITZ!OS version 7.00 or higher.

### Enabling Instructions: Mesh for the FRITZ!WLAN Repeater

1. Open the FRITZ!Box user interface, [see Instructions: Opening the User Interface, page 51](#).

2. Select "Home Network / Mesh".

The home network is displayed in a graphic overview. The FRITZ!Box is the Mesh Master and designated with the "Mesh enabled" icon: .

3. Make sure that the FRITZ!WLAN Repeater is marked with the "Mesh enabled" icon (1).

If the symbol is displayed, then the FRITZ!WLAN Repeater was already successfully integrated into the Mesh.

If the symbol is missing, continue with the next step.

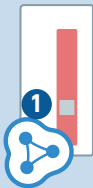

4. If the “Perform Update” button is available next to the “FRITZ!WLAN Repeater” in the overview: Perform the update and wait until the message “Update was successful” appears. If no update is available, continue with the next step.
5. Start WPS on the FRITZ!Box. To do this, press the “Connect/WPS” button on the FRITZ!Box until the “Info” LED starts flashing.
6. Within 2 minutes, start WPS on FRITZ!WLAN Repeater. Press the “WPS” button briefly.

The FRITZ!WLAN Repeater is integrated into the Mesh of the FRITZ!Box. As soon as the procedure is concluded, the FRITZ!WLAN Repeater is displayed in the Mesh Overview of the FRITZ!Box with the “Mesh enabled” symbol: .

## Integrating FRITZ!Powerline into the Mesh of the FRITZ!Box

### Overview

To expand your wireless radio network, you can integrate a FRITZ!Powerline with WiFi function into the Mesh of the FRITZ!Box. Mesh connects the individual wireless networks of your FRITZ! devices to form a combined wireless network.

### Requirements

The FRITZ!Powerline is located in the home network of a FRITZ!Box with FRITZ!OS version 7.00 or higher.

### Instructions: Integrating FRITZ!Powerline into the Mesh

1. Open the FRITZ!Box user interface; see [Instructions: Opening the User Interface, page 51](#).

2. Select "Home Network / Mesh".

The home network is displayed in a graphic overview. The FRITZ!Box is the Mesh Master and designated with the "Mesh enabled" symbol: .

3. Make sure that the FRITZ!Powerline is marked with the "Mesh enabled" symbol (1).

If the symbol is displayed, then FRITZ!Powerline was already successfully integrated into the Mesh.

If the symbol is missing, continue with the next step.

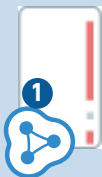

4. If the FRITZ!PowerlinePerform Update button is available next to the "" in the overview: Perform the update and wait until the message "Update was successful" appears.

If no update is available, continue with the next step.

5. Start WPS on the FRITZ!Box. To do this, press the “Connect/WPS” button on the FRITZ!Box until the “Info” LED starts flashing.
6. Within 2 minutes, start WPS on FRITZ!Powerline. To do this, press briefly on either the “Connect” or the “WLAN/WPS” button, depending on the model.

The FRITZ!Powerline is integrated into the Mesh of the FRITZ!Box. As soon as the procedure is concluded, FRITZ!Powerline is displayed in the Mesh Overview of the FRITZ!Box with the “Mesh enabled” symbol: .

## Deploying an Additional FRITZ!Box as a Mesh Repeater

### Overview

You can use another FRITZ!Box in the home network to improve the WiFi coverage in the home network. In this operating mode, a central FRITZ!Box is the Mesh Master, and the other FRITZ!Box is a Mesh Repeater. By integrating an additional FRITZ!Box as a Mesh Repeater you benefit not only from wireless repeating, but also from all other benefits of Mesh; see [Benefits of Mesh, page 74](#).

### Requirements

- The FRITZ!Box that is to serve as the Mesh Repeater was reset to its factory settings; see [page 196](#).
- The FRITZ!Box that is to serve as the Mesh Repeater has FRITZ!OS version 7.00 or higher installed; see [page 191](#).
- The FRITZ!Box that is to function as a Mesh Repeater is a network device (IP client) in the home network of the Mesh Master.

### Instructions: Deploying an Additional FRITZ!Box as a Mesh Repeater

1. Open the user interface, see [page 51](#).
2. Select "Home Network / Mesh / Mesh Settings".
3. For instructions, open the online help .



## Using Telephony in the Mesh

### Overview

In a Mesh with more than one FRITZ!Box, you can configure your telephone numbers in one FRITZ!Box (the Mesh Master) and adopt them automatically on every other FRITZ!Box in the Mesh.

Whenever you add or change telephone numbers in the Mesh Master, the changes are automatically applied to the other FRITZ!Boxes.

### Requirements

- Your telephone numbers are registered in the FRITZ!Box that is configured as the Mesh Master.
- All FRITZ!Boxes on which you would like to adopt the telephone numbers are configured as Mesh Repeaters.

### Instructions: Setting up Telephony in the Mesh

1. Open the user interface, [see page 51](#).
2. Select “Home Network / Mesh / Mesh Settings”.
3. For instructions, open the online help .

# User Interface: Overview menu

Overview Menu: Settings and Features ..... 83



## Overview Menu: Settings and Features

### Overview

The “Overview” menu is the start page of the FRITZ!Box user interface. This page presents an overview of all FRITZ!Box features and components: energy consumption, connections, ports, calls, answering machine messages, convenience functions (parental controls, alarm, etc.) and all devices in the home network.

In addition to the overview, next to the FRITZ!OS version currently installed, you will also find notifications important for secure, reliable operation of your FRITZ!Box.

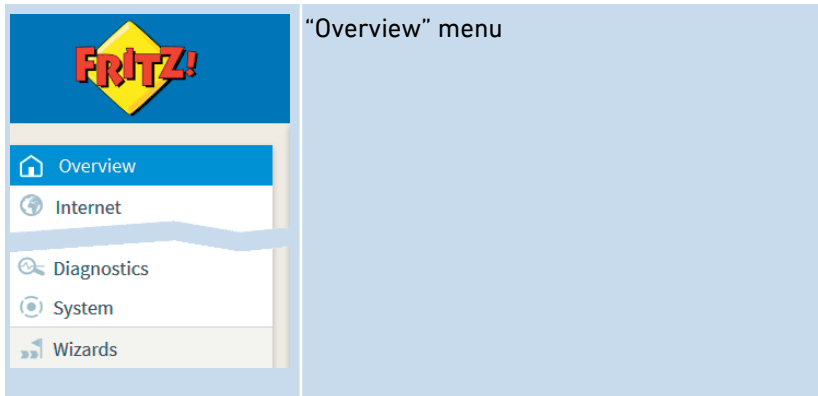

## FRITZ!Box Status Information at a Glance

The following figure shows you the different areas of the user interface that present status information:

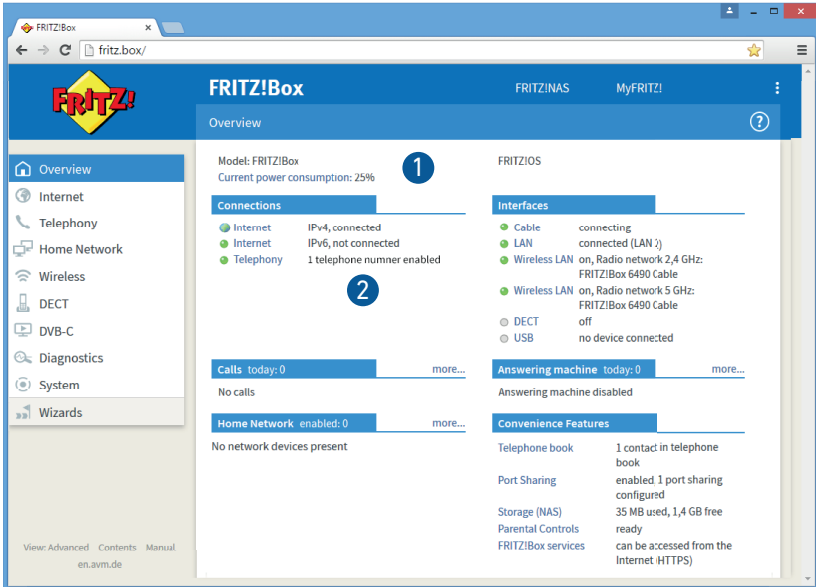

### No. Display / Function

#### 1 System information

- Product name or individually assigned name of the FRITZ!Box
- FRITZ!OS installed
- Current power consumption
- Important notifications for secure, reliable operation of your FRITZ!Box

No.	Display / Function
2	<p data-bbox="236 181 762 209">Information about connections and interfaces</p> <ul data-bbox="236 225 1006 531" style="list-style-type: none"><li data-bbox="236 225 1006 288">• Information on internet and telephony connections and on all FRITZ!Box interfaces</li><li data-bbox="236 304 1006 368">• Information on telephone calls and voice messages on the integrated answering machine</li><li data-bbox="236 384 1006 488">• Devices connected to the FRITZ!Box, such as computers, smartphones, network storage, printers, and Smart Home devices</li><li data-bbox="236 504 1006 531">• Configured convenience features</li></ul>

For a comprehensive description of the FRITZ!Box user interface: [see User Interface, page 50](#).

## User Interface: Internet menu

Internet Menu: Settings and Features.....	87
Using AVM Services for Diagnostics and Maintenance .....	88
Configuring Parental Controls .....	90
Creating and Assigning Access Profiles .....	92
Editing Filter Lists .....	94
Configuring Priorities for Internet Use .....	95
Configuring Port Sharing.....	96
Enabling Dynamic DNS.....	98
Remote Access to the FRITZ!Box .....	99
Configuring VPN Remote Access.....	101
Configuring IPv6 .....	103

## Internet Menu: Settings and Features

### Overview

The “Internet” menu pools all of the features for the internet connection. Users of the FRITZ!Box interested in technology can read information on the cable connection [here](#).

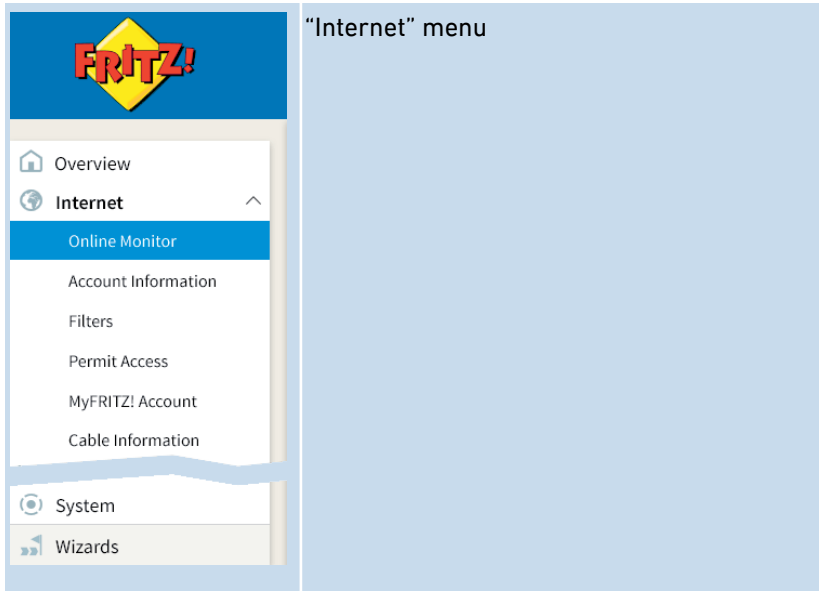

### Description of the Submenus

The online help of the user interface includes a detailed description of the submenus.

## Using AVM Services for Diagnostics and Maintenance

### Overview

The AVM services for diagnostics and maintenance keep your FRITZ!Box and the FRITZ!OS operating system up to date and support the security and further development of your FRITZ!Box.



We recommend leaving the use of all AVM services enabled for your FRITZ!device.

### AVM Services

The following AVM services are provided by your FRITZ!Box:

AVM Service	Explanation
Search for updates	Your FRITZ!Box connects with the AVM update server regularly to search for and install new versions of FRITZ!OS.
Diagnostics data for error analysis	Upon suspicions of misuse by third parties, your FRITZ!Box transmits error reports or technical diagnostics data to AVM for analysis.
Diagnostics data for system maintenance	Your FRITZ!Box transmits device-specific data to AVM for the development of security updates and to further develop FRITZ!OS.

### Data Privacy Protection

The diagnostics data and the device-specific data transmitted by your FRITZ!Box to AVM do not contain any personalized data. The data transmitted serve the exclusive purpose of technical adaptations and optimizations of your FRITZ!Box. Also, AVM does not pass these data on to third parties. The exact wording of the data privacy statement is presented under “Legal Notice / Data Privacy Statement” in the online help.



## Instructions: Configuring AVM Services

1. Open the user interface, [see page 51](#).
2. Select "Internet / Account Information / AVM Services".
3. For instructions, open the online help .

## Configuring Parental Controls

### Overview

The parental controls feature allows you to control the use of the internet by network devices. For each individual network device, you can limit the duration and content of internet use.

### Example

You have three children, all of whom use various devices that access the internet via FRITZ!Box. You would like to restrict your children's use of the internet as follows:

- Their daily time online is to be restricted to a few hours.
- Access to websites with adult content is to be blocked.

With parental controls you can restrict the internet use of each child individually.

### Profiles for Internet Use

The specifications for temporal and content-related restrictions are generated and saved as profiles. These profiles are called access profiles. You can create multiple different access profiles; see [see Creating and Assigning Access Profiles, page 92](#). You can assign these access profiles to the network devices.

### Instructions: Configuring Parental Controls for a Network Device

1. Open the user interface, [see page 51](#).
2. Select "Internet / Filters / Access Profiles".
3. If there is no access profile with the restrictions you want, then create an access profile:
  - For instructions, open the online help .

4. Select "Internet / Filters / Parental Controls".
5. Assign to the network device the access profile with the desired restrictions:
  - For instructions, open the online help .

## Creating and Assigning Access Profiles

### Overview

In an access profile you can enter the time and content restrictions for internet use. The network devices can have different access profiles. An access profile can be assigned to one or multiple network devices. A network device then accesses the internet exactly as specified in the access profile.

### Access Profile: Definition

An access profile is a provision that describes exactly what is allowed during internet use. An access profile takes into consideration three aspects of internet use:

Aspect	Description
Time limit	With time limits you can define when and for how long internet use is permitted each day.
Filters for web pages	With the filter lists you can specify which websites are allowed to be accessed.
Blocked network applications	With the list of blocked network applications you specify which network applications are allowed to communicate over the internet. This list can contain, for instance, file sharing programs or chat software.

### Example

You have three children and would like to control the internet use of each child in different ways.

- Create an individual access profile for each child.
- Include in this access profile the time and content restrictions to be imposed on the given child.

## Preconfigured Access Profiles

In the FRITZ!Box there are four preconfigured access profiles.

Name	Properties
Standard	<ul style="list-style-type: none"> <li>• Unrestricted use in the factory settings</li> <li>• Automatic access profile for network devices registering with the home network for the first time</li> <li>• Can be changed</li> </ul>
Guest	<ul style="list-style-type: none"> <li>• Automatic, exclusive access profile for network devices registering with the guest network</li> <li>• Can be changed</li> </ul>
Unrestricted	<ul style="list-style-type: none"> <li>• Unrestricted internet use</li> <li>• Cannot be changed</li> </ul>
Blocked	<ul style="list-style-type: none"> <li>• No internet use allowed</li> <li>• Cannot be changed</li> </ul>

## Creating an Access Profile

1. Open the user interface, [see page 51](#).
2. Select "Internet / Filters / Access Profiles".
3. For instructions, open the online help .

## Assigning an Access Profile

1. Open the user interface, [see page 51](#).
2. Select "Internet / Filters / Parental Controls".
3. For instructions, open the online help .

## Editing Filter Lists

### Overview

You can use a filter list to block access to websites with inappropriate content. Upon delivery, there are two empty lists in the FRITZ!Box. You can enter websites in these lists. These lists can then be used as filters in the access profiles.

### Types of Lists

Access to websites with inappropriate content can be blocked using the blacklist or whitelist.

Filter List	Function and Use
Blacklist	<ul style="list-style-type: none"> <li>• Access is blocked to websites included in the blacklist.</li> <li>• Use the blacklist if access to most websites is allowed and just a few are to be blocked.</li> </ul>
Whitelist	<ul style="list-style-type: none"> <li>• Access is allowed to websites included in the whitelist.</li> <li>• Use the whitelist if access to most websites is blocked and only a few are allowed to be accessed.</li> </ul>

### Instructions: Editing Filter Lists

1. Open the user interface, [see page 51](#).
2. Select "Internet / Filters / Lists".
3. For instructions, open the online help .

## Configuring Priorities for Internet Use

### Overview

For network devices or network applications you can define different priorities for access to the internet connection.

### Prioritization Categories

There are three prioritization categories for network applications:

- Real-time applications have the highest priority. This category is intended for applications with high demands on transmission speed and reaction times (for example, internet telephony, IPTV, video on demand). If an application of this category uses the internet connection to full capacity, no other data will be transmitted.
- Prioritized applications have intermediate priority. This category is intended for applications that require a fast reaction time (for example, company access, terminal applications, games). These applications will be granted higher priority. When an application of this category uses the full capacity of the internet connection, the data of other applications will be transferred with lower priority.
- Background applications have the lowest priority. This category is for applications that run in the background, which are treated with low priority when the internet connection is running at capacity (for instance, automatic updates, peer-to-peer services). If no other network applications are active, then the background applications receive the entire bandwidth.

### Instructions: Configuring Priorities

1. Open the user interface, [see page 51](#).
2. Select "Internet / Filters / Prioritization".
3. For instructions, open the online help .

## Configuring Port Sharing

### Overview

With default settings in the FRITZ!Box, programs on your computer and LAN cannot be accessed from the internet. For applications like online games and file sharing software or server services like HTTP, FTP, VPN, terminal and remote access servers, you have to make your computer accessible for other internet users.

### Port Sharing

Using port sharing you allow incoming connections from the internet. By releasing certain ports for incoming connections, you grant controlled access to the computers in your network to other internet users.

### Port Sharing on Protocols

Port sharing in the FRITZ!Box is possible on the following protocols:

Protocol	Internet Protocol	Explanation
PING	IPv6	The FRITZ!Box responds to ping inquiries from the internet addressed to the IPv6 address of the FRITZ!Box. Additionally, you can set up PING6 port sharing rules for each computer in the home network since each computer has its own globally valid IPv6 address.
TCP UDP	IPv4	Within IPv4 networks you can open the FRITZ!Box firewall for the TCP and UDP protocols when entering the port range. One port can be opened for exactly one computer.



Protocol	Internet Protocol	Explanation
	IPv6	Within IPv6 networks you can open the FRITZ!Box firewall for the TCP and UDP protocols when entering the port range. One port can be opened for each computer in the network.
ESP GRE	IPv4	Within IPv4 networks you can open the firewall for the two protocols ESP and GRE, which do not use ports.

### Instructions: Configuring Port Sharing

1. Open the user interface, [see page 51](#).
2. Select "Internet / Permit Access / Port Sharing".
3. For instructions, open the online help .

## Enabling Dynamic DNS

### Overview

Every time the internet connection is interrupted, the internet service provider re-assigns the IP address. The IP address may change in the process. Dynamic DNS is an internet service that makes it possible for the FRITZ!Box to remain accessible from the internet at all times under a fixed name, the domain name, even when the public IP address changes.

You must register with a dynamic DNS provider to use this service. Every time the IP address changes, the FRITZ!Box transmits the new IP address to the dynamic DNS provider in the form of an update request. Then the domain name is assigned to the current IP address by the dynamic DNS provider.

### Dynamic DNS and MyFRITZ!

MyFRITZ! can be used as an alternative to dynamic DNS. The two services can also be used in parallel. For more information on MyFRITZ!; see [MyFRITZ!](#), page 210.

### Requirements

- You are registered with a dynamic DNS provider and have set up a domain name.
- The advanced view is enabled in the FRITZ!Box user interface (see [Using the Standard View and Advanced View](#), page 58).

### Instructions: Enabling Dynamic DNS

1. Open the user interface, see [page 51](#).
2. Select "Internet / Permit Access / DynDNS".
3. For instructions, open the online help .

## Remote Access to the FRITZ!Box

### Overview

Over the internet it is possible to access the user interface of the . With a laptop, smartphone or tablet you can configure settings in the FRITZ!Box user interface. Over the internet it is possible to access the user interface of the . With a laptop, smartphone or tablet you can configure settings in the FRITZ!Box user interface.

### HTTPS, FTP and FTPS

Protocol	Function
HTTPS (Hypertext Transfer Protocol Secure)	<p>HTTPS is an internet protocol for bug-proof communication between the web server and the browser in the World Wide Web.</p> <p>Enable this protocol to allow access to the FRITZ!Box from the internet.</p>
FTP (File Transfer Protocol)	<p>FTP is a network protocol for transmitting files in IP networks.</p> <p>Enable this protocol to allow access by FTP to the FRITZ!Box storage media from the internet.</p>
FTPS (FTP over SSL)	<p>FTPS is a method for encrypting the FTP protocol.</p> <p>Enable this protocol to secure transmission over FTP.</p>

## Requirements

- Access to the user interface: Every user who would like to access the FRITZ!Box externally from the internet requires a FRITZ!Box user account that is authorized for access from the internet.
- Access to storage: Every user who would like to access the storage of the FRITZ!Box externally from the internet requires a FRITZ!Box user account with the rights to access from the internet and to access the contents on the storage media.
- The protocols for the desired access must be enabled in the FRITZ!Box.

## Instructions: Enabling HTTPS, FTP and FTPS in the FRITZ!Box

1. Open the user interface, [see page 51](#).
2. Select "Internet / Permit Access / FRITZ!Box Services".
3. For instructions, open the online help .

## Configuring VPN Remote Access

### Overview

VPN stands for Virtual Private Network. Via VPN, secure remote access to the network of the FRITZ!Box can be established. The connection is established via the internet. The data are transmitted in encrypted form via what is known as a tunnel. This excludes the possibility of unauthorized access to the data. In this way you can allow field representatives to connect with the corporate network over VPN – for instance, via their own laptops.



This section addresses system administrators.

That is why the settings for this function are enabled only in the advanced view of the FRITZ!Box user interface.

### Example Configuration

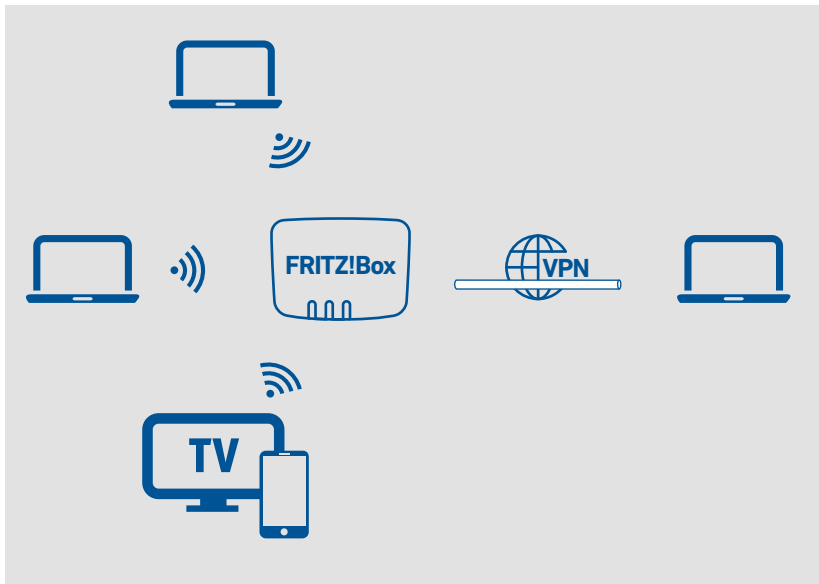

## Alternative

Setting up remote access via VPN can overwhelm the layman. It is easier to set up access from outside via MyFRITZ!. For more information see [MyFRITZ!](#), page 210.

## VPN Service Portal

The AVM website offers a service page which presents comprehensive information on VPN in general and in connection with the FRITZ!Box. If you would like to find out even more, visit this page at:

[en.avm.de/service/vpn](http://en.avm.de/service/vpn)

Also on the VPN Service Portal is the “FRITZ! VPN” software for free downloading. The “FRITZ! VPN” software is a VPN client. Install the program on the computers and laptops from which you would like to reach the FRITZ!Box over a VPN connection.

## Instructions: Configuring VPN in the FRITZ!Box

1. Open the user interface, see [page 51](#).
2. Select “Internet / Permit Access / VPN”.
3. For instructions, open the online help .

## Configuring IPv6

### Overview

IPv6 stands for internet protocol version 6. It is the successor to IPv4, which is to be replaced completely by IPv6 in the coming years. IPv6 is more powerful, and has more addresses and better security properties than IPv4.

The FRITZ!Box supports the new IPv6 internet protocol and can establish IPv6 connections:

### Services that Support IPv6

Home Network / Internet	Services that Support IPv6
IPv6-capable services in the home network	<ul style="list-style-type: none"> <li>• FRITZ!NAS access via SMB or FTP/FTPS</li> <li>• Access to the user interface with http or https over IPv6</li> <li>• The DNS resolver of the FRITZ!Box supports queries for IPv6 addresses (AAAA records) and can query the upstream DNS resolver of the internet service provider over IPv6.</li> <li>• The globally valid prefix is distributed via router advertisement.</li> <li>• For guest access to the wireless LAN, the home network and wireless guests are separated by IPv6 subnetworks.</li> <li>• UPnP, UPnP AV media server</li> </ul>

Home Network / Internet	Services that Support IPv6
IPv6-capable services in the internet	<ul style="list-style-type: none"> <li>• FRITZ!NAS access via FTPS</li> <li>• Completely closed firewall to protect against unsolicited data from the internet (Stateful Inspection Firewall)</li> <li>• Voice over IPv6</li> <li>• Automatic provisioning (TR-069)</li> <li>• Time synchronization over NTP (Network Time Protocol)</li> <li>• Remote access via HTTPS</li> <li>• Dynamic DNS via dyndns.org or namemaster.de</li> </ul>

## Requirements

- IPv6 must be installed and enabled on the computers in your home network (standard in Windows since Windows Vista and Windows 7, in Mac OS X since macOS 10).
- The advanced view must be enabled in the FRITZ!Box user interface; see [Using the Standard View and Advanced View, page 58](#).

## Instructions: Configuring IPv6 in the FRITZ!Box

1. Open the user interface, see [page 51](#).
2. Select "Internet / Account Information / IPv6".
3. For instructions, open the online help .



## User Interface: Telephony Menu

Telephony Menu: Settings and Features .....	106
Configuring and Using the Telephone Book .....	107
Configuring and Using the Answering Machine .....	109
Using the Fax Function.....	111
Configuring Call Diversion .....	112
Configuring Call Blocks .....	113
Configuring Do Not Disturb .....	115
Setting an Alarm .....	116
Configuring a Dialing Rule .....	117

## Telephony Menu: Settings and Features

### Overview

In the “Telephony” menu you configure your telephone numbers, telephones and other connected devices (for instance fax machine, door intercom system). You can also configure the FRITZ!Box answering machine, the internal fax function and various other features: the telephone book, alarm, call blocks, call diversion, call through and dialing rules.

The call list shows all of the calls you made, accepted or missed.

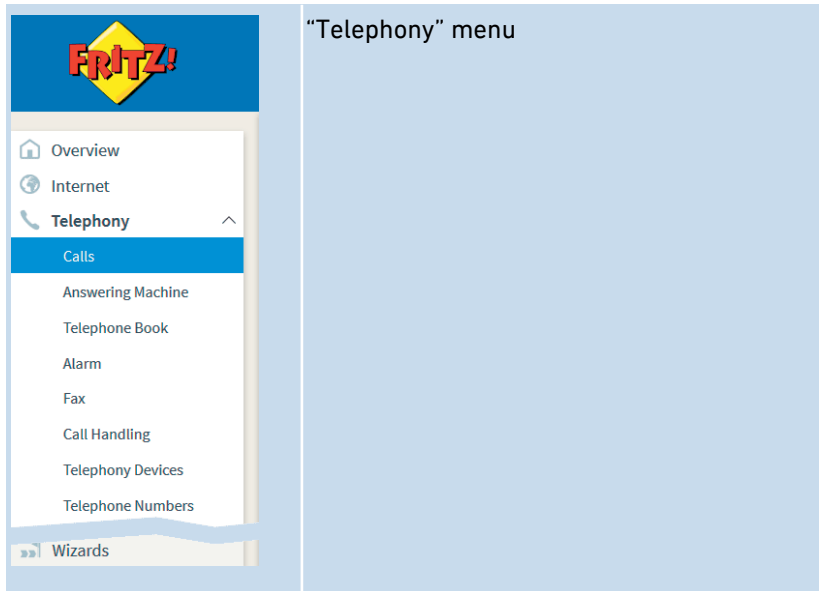

### Description of the Submenus

The online help of the user interface includes a detailed description of the submenus.

## Configuring and Using the Telephone Book

### Overview

How you can use the FRITZ!Box telephone book depends on the telephone used:

Telephone	Available Functions
FRITZ!Fon	<ul style="list-style-type: none"> <li>• Telephone book available in the FRITZ!Fon menu</li> <li>• Option for separate telephone books for multiple FRITZ!Fon telephones</li> <li>• Quick-dial numbers</li> <li>• Click to dial</li> </ul>
Cordless telephone with CAT-iq 2.0 support	<ul style="list-style-type: none"> <li>• Telephone book available in the telephone menu</li> <li>• Quick-dial numbers</li> <li>• Click to dial</li> </ul>
Others	<ul style="list-style-type: none"> <li>• Quick-dial numbers</li> <li>• Click to dial</li> </ul>

### Kinds of Telephone Books

You can set up different kinds of telephone books in the FRITZ!Box:

Telephone Book	Description
Local telephone book	The entire telephone book is saved in the FRITZ!Box.

Telephone Book	Description
Online telephone book	<p>Online telephone books include Google Contacts and the contacts of email accounts with 1&amp;1, GMX or WEB.DE.</p> <p>The online telephone book is available in the FRITZ!Box and synchronized with your telephone book in the internet at regular intervals.</p>

You can set up multiple local and multiple online telephone books, for instance, separate telephone books for different FRITZ!Fon telephones. Quick-dial numbers can be configured only in the first local telephone book.

#### Instructions: Setting up a New Telephone Book in FRITZ!Box

1. Open the user interface, [see page 51](#).
2. Select "Telephony / Telephone Book / New Telephone Book".
3. For instructions, open the online help .

#### Instructions: Creating an Online Telephone Book

1. Open the user interface, [see page 51](#).
2. Select "Telephony / Telephone Book / New Telephone Book".
3. For instructions, open the online help .

#### Instructions: Creating a New Telephone Book Entry

1. Open the user interface, [see page 51](#).
2. Select "Telephony / Telephone Book".
3. For instructions, open the online help .

#### Instructions: Enabling and Using "Click to Dial"

1. Open the user interface, [see page 51](#).
2. Select "Telephony / Telephone Book / Click to Dial".
3. For instructions, open the online help .

## Configuring and Using the Answering Machine

### Overview

In the FRITZ!Box you can configure an answering machine, making an additional device superfluous. If you have more than one telephone number, you can set up multiple answering machines (up to five).

### Features

- Messages by email: If desired, you can receive new messages automatically by email.
- Schedule: You can define times to switch on and off on different days of the week.
- Remote playback: You can check the answering machine from on the go.

### Requirements

- For each answering machine you configure, a telephone number is required.

### Example

You have two telephones with different telephone numbers (for instance, one for personal calls and one for business calls). Then you can configure an answering machine for each telephone. Assign your personal telephone number to the first answering machine and your office number to the second one.

### Instructions: Configuring the Answering Machine

1. Open the user interface, [see page 51](#).
2. Select "Telephony / Answering Machine".
3. For instructions, open the online help .

## Operating Answering Machines by Telephone

Using a voice menu you can operate the answering machine on any telephone connected with the FRITZ!Box. You can listen to new messages, for instance, or switch the answering machine on and off. For instructions, [see page 233](#).

## Picking Up a Call from the Answering Machine on the Telephone

Calls that have already been accepted by the answering machine can be picked up on your telephone. For more information, [see page 235](#).

## Instructions: Listening to the Answering Machine via Remote Playback

If you enabled remote playback in the configuration of the answering machine, then you can listen to an enabled answering machine from on the go:

1. Call your telephone line.
2. When the answering machine answers: Press the \* (star) key on the telephone and then enter the remote playback PIN.
3. Follow the voice menu.

## Using the Fax Function

### Overview

With the FRITZ!Box you can send and receive faxes. Received faxes are forwarded by the FRITZ!Box by email or saved on a USB storage medium. Send the fax from the user interface. Graphic files in JPG or PNG format can be appended to any fax transmission.

### Maximum fax length

A maximum of two A4 pages can be transmitted as a fax. When a fax with an appended graphic file is sent, the second page is reserved for the graphic file.

When sending a fax it is not always apparent whether the entire text was transmitted. You can check that a fax was sent completely after the fact. To do this, enable forwarding by email in the configuration of the fax function. Then the FRITZ!Box will automatically forward to your email address all faxes sent as well as those received.

### Instructions: Configuring the Fax Function

1. Open the user interface, [see page 51](#).
2. Select "Telephony / Telephony Devices".
3. For instructions, open the online help .

### Instructions: Sending faxes

1. Open the user interface, [see page 51](#).
2. Select "Telephony / Fax".
3. For instructions, open the online help .

## Configuring Call Diversion

### Overview

You can configure call diversion for incoming calls in the FRITZ!Box.

### Incoming calls

Call diversion can be set up for the following calls:

- All incoming calls
- All calls from a certain telephone number or a certain person in the telephone book
- All calls without a telephone number (anonymous calls)
- For multiple telephone numbers: all calls for a certain telephone number or a certain telephone

### Destination Numbers

You can divert calls to:

- Another telephone number (a different telephone line or mobile telephone number)
- One of the FRITZ!Box's internal answering machines

### Example

While you are on the go, calls are to be forwarded from the office to your mobile telephone.

### Instructions: Configuring Call Diversion

1. Open the user interface, [see page 51](#).
2. Select "Telephony / Call Handling / Call Diversion".
3. For instructions, open the online help .



## Configuring Call Blocks

### Overview

In the FRITZ!Box you can block telephone numbers for outgoing and for incoming calls.

### Kinds of Call Blocks

You can configure various kinds of call blocks:

Call block for	Function
Outgoing calls	The blocked telephone number can no longer be called from the FRITZ!Box.  Ranges of telephone numbers can also be blocked, for instance, mobile networks, or all telephone numbers that begin with 0180.
Incoming calls	The FRITZ!Box will not accept calls from the blocked telephone number. However, the call block only works if the caller allows transmission of her or his telephone number.
Calls without a telephone number (anonymous calls)	The FRITZ!Box will not accept any calls from callers who suppress their telephone number.

### Example 1

You would like to prevent dialing of expensive premium telephone numbers. For this you can set up a call block for outgoing calls to all telephone numbers that begin with 0900.

### Example 2

You would like to block sales calls from a certain telephone number. For this you can set up a call block for incoming calls from this telephone number.

## Instructions: Configuring a Call Block

1. Open the user interface, [see page 51](#).
2. Select “Telephony / Call Handling / Call Blocks”.
3. For instructions, open the online help .

## Configuring Do Not Disturb

### Overview

Do Not Disturb keeps a telephone from ringing at specified times. Calls you miss then appear in the FRITZ!Box call list. Do Not Disturb cannot be configured for IP telephones (connected via LAN port/wireless LAN).

### Example

You do not want your telephone to ring between 11 pm and 6 am.

### Instructions: Configuring Do Not Disturb

1. Open the user interface, [see page 51](#).
2. Select "Telephony / Telephony Devices / Edit / Do Not Disturb".
3. For instructions, open the online help .

## Setting an Alarm

### Overview

Setting an alarm will make your telephone ring at the specified time.

### Example

You would like your telephone to wake you at 6:30 am every morning.

### Instructions: Configuring an Alarm

1. Open the user interface, [see page 51](#).
2. Select "Telephony / Alarm".
3. For instructions, open the online help .

## Configuring a Dialing Rule

### Overview

If you have multiple telephone numbers, you can configure dialing rules. A dialing rule determines which telephone number the FRITZ!Box uses for outgoing calls to a certain range of numbers, for instance to mobile networks or to foreign countries.

### Example

You have a telephone number with which you can save on international calls. Then configure a dialing rule for international calls.

### Instructions: Configuring Dialing Rules

1. Open the user interface, [see page 51](#).
2. Select “Telephony / Call Handling / Dialing Rules”.
3. For instructions, open the online help .

## User Interface: Home Network menu

Home Network Menu: Settings and Features.....	119
Managing the Home Network.....	120
Managing Network Devices .....	123
Changing IPv4 Settings .....	126
Distributing IPv4 Addresses .....	129
Changing IPv6 Settings .....	132
Configuring a Static IP Route .....	134
Obtaining an IP Address Automatically .....	136
Configuring LAN Guest Access .....	138
Configuring Wake on LAN .....	140
Configuring USB Devices .....	141
Configuring and Using the Media Server .....	149
Assigning a FRITZ!Box Name .....	151
Controlling Smart Home Devices .....	152

## Home Network Menu: Settings and Features

### Overview

Your home network consists of the FRITZ!Box and all of the devices connected to it. The FRITZ!Box is the hub in your home network. In the “Home Network” menu you can configure all of the settings relevant for your home network.

A graphic overview of your home network with all connected devices is presented in the “Home Network / Mesh” menu.

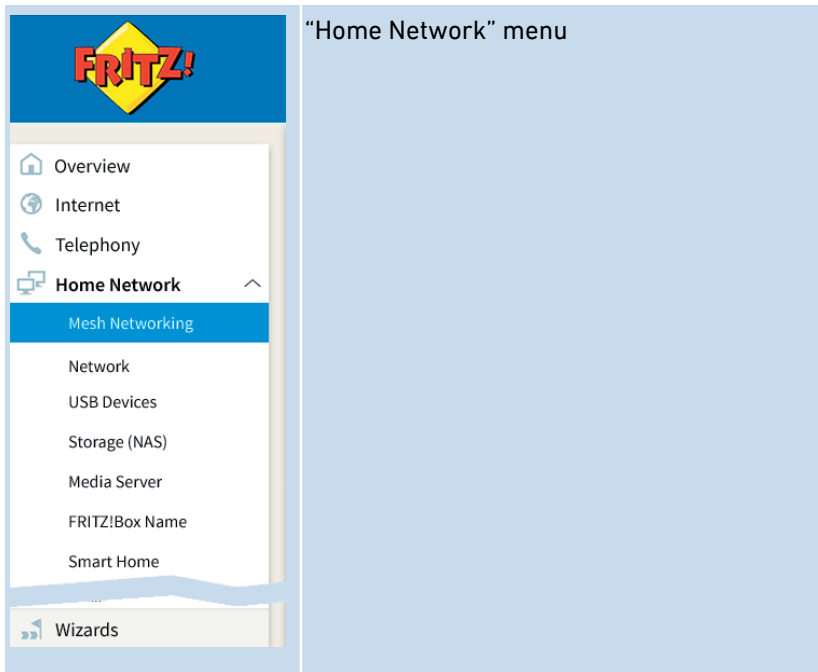

### Description of the Submenus

The online help of the user interface includes a detailed description of the submenus.

## Managing the Home Network

### Overview

The overview of your FRITZ!Box home network in the “Mesh Overview” menu notifies you which devices are currently active in the home and guest networks, how they are connected with each other, and what throughput rates are available over the individual connections. And from here you can update all FRITZ! products in your home network and integrate them into the FRITZ!Box Mesh.

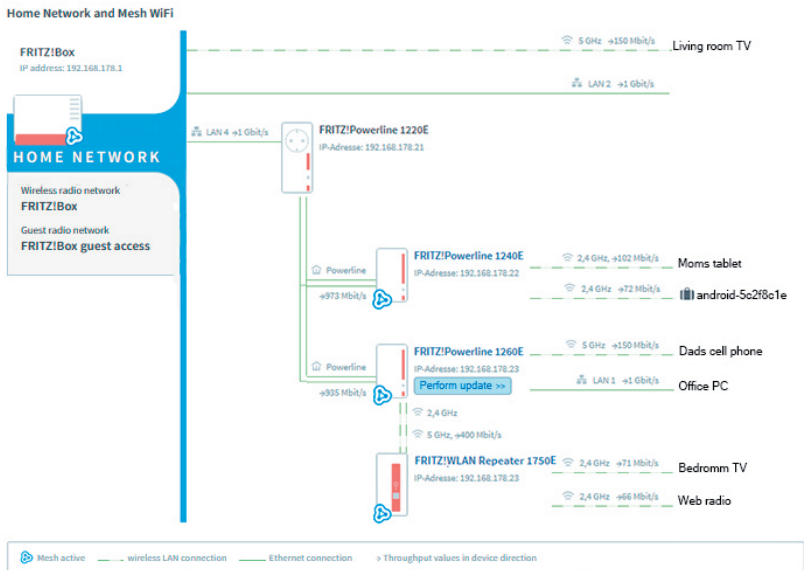

### Home Network and Mesh

An overview diagram shows all of the devices connected with the FRITZ!Box along with all Mesh Repeaters.





The overview diagram displays the following information:

- The FRITZ!Box: the IP address of the FRITZ!Box in the home network, the SSID of the wireless radio network and the SSID of the guest network, if it is enabled
- All devices that are connected with the FRITZ!Box
-  “Mesh enabled”: this symbol marks the devices that are repeaters in the Mesh
-  Update: This button indicates whether a new FRITZ!OS is available (only for FRITZ! products)
- Connection technology: wireless LAN, Ethernet cable, DECT, powerline, USB
- Connection path of the devices to the FRITZ!Box: direct connection or via a repeater or access point
- Throughput values in device direction
- Guest access: devices that are connected with the FRITZ!Box via the guest network

### Active Connections and Current Software Version

All devices connected with the FRITZ!Box are displayed in the “Active connections in the home network and current software version” table:

- FRITZ!Box: the FRITZ!Box itself
- Network devices: all network devices connected with a network cable or via wireless LAN, for example: computers (PCs, laptops), mobile terminal devices (tablets, smartphones), wireless repeaters, TV sets
- Telephones: all of the telephones connected with the FRITZ!Box
- USB devices: all connected USB devices, for example USB storage media, USB printers, USB mobile broadband dongles
- Smart Home devices: Smart Home devices connected with the FRITZ!Box, for example, smart plugs or radiator controls

In the “Connections”, “Properties”, and “Update” columns you can click links to the connection settings or the device settings and perform updates:

Column Name	Contents / Advantages
Device / Name	The name or the designation with which the device is registered with the FRITZ!Box.
Connection	The connection technology with which the device is connected with the FRITZ!Box. Click on the link to open the page with connection settings.
Properties	Information on the devices. For devices from FRITZ!, the current FRITZ!OS version will be displayed. For network devices there is a “Details” link with which you can open the detailed view for the given device.
FRITZ!Box Update	For FRITZ! products, the “Update” column displays whether the installed FRITZ!OS is the latest, or whether an update is available. If there is an update, you can install it directly from the table.

## Managing Network Devices

### Overview

In the FRITZ!Box user interface, a table listing all network connections is shown under “Home Network / Network / Network Connections”. A network connection is an IP connection between a network device and the FRITZ!Box. By means of the table you can keep track of the network connections and all network devices. You can edit the connection properties, and add and remove network devices.

### Explanation of Terms: Network and Other Terms



Term	Explanation
Network device	<p>Network devices are devices that are connected with the FRITZ!Box in one of the following ways:</p> <ul style="list-style-type: none"> <li>• with a network cable to a LAN port on the FRITZ!Box</li> <li>• via wireless LAN</li> <li>• via the internet with a VPN connection (<a href="#">see page 101</a>)</li> </ul>
Network	All network devices on the FRITZ!Box comprise a network.
Internet protocol (IP)	<p>Communication within the network takes place using the internet protocol, IP for short. The internet protocol is the language that all network devices speak and understand. Communication within the network takes place using the internet protocol, IP for short.</p>

Term	Explanation
IP network	A network based on the internet protocol is also known as an IP network. Connections within an IP network are known as IP connections. Connections within an IP network are known as IP connections.
Network interface	A network interface is the interface used to connect a network device with a network. It can be a wireless LAN radio module for wireless connections or a network port for cabled connections.

### Properties and Benefits

The table with the network connections has the following properties that can be useful in organizing and keeping track of the IP network:

- **Overview:** The table offers an overview of the entire IP network of the FRITZ!Box.
- **All connections:** Every connection any network device has to the FRITZ!Box is displayed. A connection can be established with a network cable, via wireless LAN, or over VPN. A network device that is connected sometimes with a network cable, and sometimes via wireless LAN, has two entries in the table, one for each connection.
- **Inactive connections:** Even connections that are currently not active are displayed.
- **Only shown here:** VPN connections are displayed only in this table.
- **Guest network overview:** Connections to the guest network are displayed.
- **Connection properties:** Properties are displayed for every connection.

- Find devices quickly: Table columns can be displayed and hidden using the  button, and table columns can be sorted in ascending  or descending  order.
- Changing connection properties: A detailed view can be opened for each connection. Connection properties can be changed in the detailed view.

## Add Device

You can include in the overview even network devices that are not physically connected with the FRITZ!Box.

As soon as an entry for a device is included in the table, you can configure various properties, for instance, port sharing. The type of connection is not listed in the table until the device is physically connected with the FRITZ!Box.

## Example

The “Add Device” function is useful for vendors. When a customer orders a new FRITZ!Box, she or he can have the vendor set up the network in the FRITZ!Box. With the “Add Device” function this can be done without actually connecting any network devices.

## Removing Devices

Unused connections can be removed individually or all at once, as long as they do not have any special settings. When a single unused connection is removed, all of the settings configured for this device are also deleted.

A click on the “Remove” button removes all inactive connections for which properties were never assigned. This function is useful in the following situations:

- in environments with walk-in customers (for example, hotels, cafés, betting offices)
- in households with children who often invite their friends to use the wireless LAN

## Changing IPv4 Settings

### Overview

The IPv4 settings define the IPv4 network of the FRITZ!Box. Without these settings there is no IPv4 network. In the FRITZ!Box an IPv4 network is the default setting. You can change the IPv4 settings.



Changes to the IPv4 settings can have the result that the FRITZ!Box can no longer be reached. Only make changes in this menu if you are proficient in network technology.

### Application Scenario

In the following cases it is necessary to change the IPv4 address of the FRITZ!Box:

- VPN connection: The home network of the FRITZ!Box is connected with another FRITZ!Box network via a LAN-LAN linkup.
- The FRITZ!Box is integrated in an existing FRITZ!Box network and both boxes are operating in router mode (cascaded).

In both cases the boxes involved cannot have identical IPv4 networks. The IPv4 address must be changed in at least one FRITZ!Box.

### Requirements

- The IPv4 settings can be changed only when the advanced view is enabled in the FRITZ!Box; [see page 58](#).

### IPv4 Factory Settings

The following values are preconfigured in the FRITZ!Box:

IPv4 Setting	Preset Value
IPv4 address of the FRITZ!Box	192.168.178.1
Subnet mask	255.255.255.0

IPv4 Setting	Preset Value
IPv4 network address	192.168.178.0
Address range available for network devices	192.168.178.2 - 192.168.178.254
DHCP server	enabled
Address range of the DHCP server	192.168.178.20 - 192.168.178.200
Local DNS server	192.168.178.1

### Reserved IPv4 Addresses

The following IPv4 addresses are reserved for certain tasks and cannot be assigned for any other use:

IPv4 Address	Purpose
192.168.178.1	IPv4 address of the FRITZ!Box
192.168.178.255	Broadcast address. This address is used to send messages within the network. The messages are received by all network devices.

IPv4 network	Purpose
192.168.100.0	In compliance with the DOCSIS specification, this network is reserved for the cable provider and is used for diagnostic and maintenance purposes.

### IPv4 Address in Case of Emergency

The FRITZ!Box also has a fixed IPv4 address that cannot be changed. The FRITZ!Box can always be reached at this IPv4 address.

IPv4 Address	Purpose
169.254.1.1	The FRITZ!Box can always be reached at this IPv4 address.

For instructions for using the emergency IPv4 address, see [Opening the User Interface with the Emergency IP Address, page 252](#).

### IPv4 network

IPv4: IPv4 stands for internet protocol, version 4. Together, the IPv4 address of the FRITZ!Box and the subnet mask specify the IPv4 network of the FRITZ!Box. The IPv4 address range available for the network devices is determined by this network. If either of these two values is changed, a different network results.

### Instructions: Changing the IPv4 Settings

1. Open the user interface, see [page 51](#).
2. Select "Home Network / Home Network Overview / Network Settings".
3. For instructions, open the online help .



## Distributing IPv4 Addresses

### Overview

Every network device in the IPv4 home network of the FRITZ!Box has an address from the IPv4 address range of the FRITZ!Box. Either a network device receives its IPv4 address automatically from the DHCP server of the FRITZ!Box, or you enter the IP address manually in the network settings of the network device.

### IPv4 DHCP Server

DHCP stands for Dynamic Host Configuration Protocol. A DHCP server in the IPv4 network assigns IPv4 addresses to the network devices automatically. Assigning the IP addresses via the DHCP server ensures that all of the network devices connected with the FRITZ!Box are located in the same IP network.

The DHCP server of the FRITZ!Box is enabled upon delivery.

One part of the IPv4 address range of the FRITZ!Box is reserved for the DHCP server. The DHCP server assigns IP addresses from this range to the network devices.

#### IPv4 Addresses Reserved for the DHCP Server upon Delivery

192.168.178.20 - 192.168.178.200

You can change the address range for the DHCP server if needed:

Kind of Change	Requirement
Enlarge	If there are many network devices in the network, many IP addresses will be needed. In this case the address range of the DHCP server can be enlarged. Example for a larger range: 192.168.178.20 - 192.168.178.220

Kind of Change	Requirement
Reduce	If there are fewer network devices, the address range can be reduced. Example for a smaller range: 192.168.178.20 - 192.168.178.120
Move	If you permanently assign the IPv4 addresses 192.168.178.2 - 192.168.178.49 to network devices, but want to maintain a DHCP address range of the same size, then you can shift the DHCP address range, for instance to the range 192.168.178.50 - 192.168.178.230

## Rules

Only one DHCP server may be active in a network.

## Preparing Network Devices for DHCP

For the IP address to be assigned by the DHCP server, the “Obtain an IP address automatically” option must be enabled in the IPv4 settings of the network devices; see [Obtaining an IP Address Automatically](#), page 136.

When a network device registers with the FRITZ!Box, it receives an IPv4 address from the DHCP server. Every time the network device is restarted, the DHCP server assigns it an IP address again.

## Always Assigning the Same IPv4 Address

You can specify that the DHCP server always assign the same IPv4 address to network devices. This option can be enabled under “Home Network / Network / Network Connections” in the detailed settings of the network devices.

## Disabling the DHCP Server

You can disable the DHCP server of the FRITZ!Box.

In the following cases it is necessary to disable the DHCP server of the FRITZ!Box:

- You use a different DHCP server in your home network.
- You would like to assign addresses to all of the network devices in the home network manually.

## Changing IPv6 Settings

### Overview

The FRITZ!Box has preconfigured IPv6 settings upon delivery. You can change these settings.

### Requirements

- The advanced view is enabled in the FRITZ!Box user interface; [see page 58](#).
- The “IPv6 support enabled” setting is enabled under “Internet / Account Information / IPv6” in the FRITZ!Box user interface.

### Factory Settings

The following settings for the IPv6 network of the FRITZ!Box are preset upon delivery:

Topic	Setting
Unique Local Addresses (ULA)	As long as there is no IPv6 internet connection, the FRITZ!Box assigns unique local addresses to the network devices so that they can communicate with each other.
Additional IPv6 routers in the home network	This FRITZ!Box provides the default IPv6 connection. Other IPv6 routers are disregarded.
DNSv6 server in the home network	Also announce DNSv6 server via router advertisement.
DHCPv6 server in the home network	The DHCPv6 server is enabled. Only the DNS server is announced via DHCPv6.

You can change the settings. For more information on this subject, see the online help of the FRITZ!Box.

### Instructions: Changing the IPv6 settings

1. Open the user interface, [see page 51](#).
2. Select "Home Network / Network / Network Settings".
3. For instructions, open the online help .

## Configuring a Static IP Route

### Overview

A static IP route is a description of a path to an IP subnet whose network address is not known to the FRITZ!Box.

### Application Scenario

Static IP routes are intended for the following situation:

- In the FRITZ!Box network there is a subnet whose network address in the FRITZ!Box is unknown.
- The network devices in the subnet are to communicate with the network devices of the FRITZ!Box or access the internet via the FRITZ!Box.
- Only relevant for IPv4: The router that spans the subnet does not do NAT (Network Address Translation).

### How Static IP Routes Work

IP packets whose IP destination addresses are unknown are forwarded to the internet by default. In the application described above, because the FRITZ!Box does not know the destination addresses that belong to the subnet, it forwards the packet to the internet. To prevent this from happening, the FRITZ!Box must know the network address of the subnet and the IP address of the interface to the subnet. These two addresses are required to configure a static route. Static IP routes are registered in the routing table.

### Requirements

- Static IP routes can be configured only when the advanced view is enabled; see [Using the Standard View and Advanced View, page 58](#).

### Instructions: Configuring a Static IPv4 Route

1. Open the user interface, see [page 51](#).

2. Select "Home Network / Network / Network Settings".
3. For instructions, open the online help .

### Instructions: Configuring a Static IPv6 Route

1. Open the user interface, [see page 51](#).
2. Select "Home Network / Network / Network Settings".
3. For instructions, open the online help .

## Obtaining an IP Address Automatically

### Overview

Network devices that are to obtain their IP address automatically by DHCP must be configured accordingly. This configuration is performed on the operating system level in the IP settings of the network devices.

### Obtaining an IP Address Automatically in Windows

1. In Windows 10 and 7 click "Start".  
In Windows 8, press the Windows key and the Q key at the same time.
2. Enter "ncpa.cpl" in the search field and press Enter.
3. Click the network connection between the computer and the FRITZ!Box with the right mouse button and select "Properties".
4. Under "This connection uses the following items", select "Internet Protocol Version 4 (TCP/IPv4)".
5. Click the "Properties" button.
6. On the "General" tab, enable the options "Obtain an IP address automatically" and "Obtain DNS server address automatically".

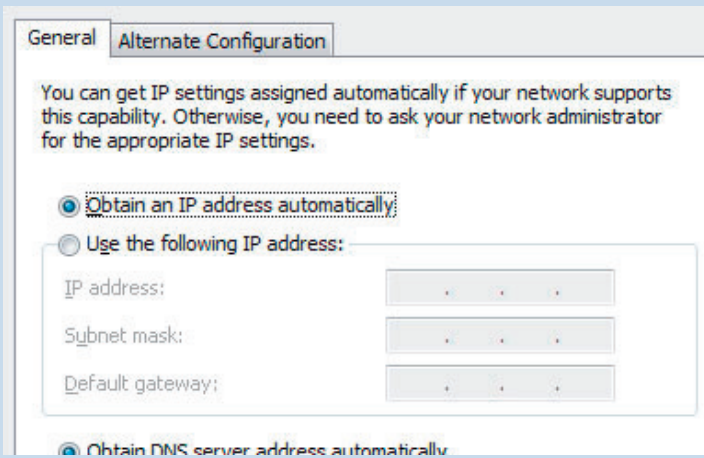



7. Click "OK" to save the settings.
8. Enable the options "Obtain an IP address automatically" and "Obtain DNS server address automatically" for the internet protocol version 6 (TCP/IPv6) as well.

The network device receives an IP address from the FRITZ!Box.

### Obtaining an IP Address Automatically in Mac OS X

1. Select the "System Preferences" in the Apple menu.
2. In the "System Preferences" window, click "Network".
3. In the "Network" window, select the "Ethernet" entry from the "Show:" list.
4. Click the "Advanced..." button. The "TCP/IP" settings page opens. Select the "Using DHCP" option from the "Configure IPv4:" drop-down list.
5. Click "OK".

The network device now automatically receives an IP address from the FRITZ!Box.

### Obtaining an IP Address Automatically in Linux

For comprehensive information and tips on network settings in Linux, see, for example:

[www.tldp.org/HOWTO/NET3-4-HOWTO-5.html](http://www.tldp.org/HOWTO/NET3-4-HOWTO-5.html)

## Configuring LAN Guest Access

### Overview

With a LAN guest access you can provide houseguests with an internet connection of their own via network cable (LAN cable). A guest access is a user account for temporary users. A guest access can also be made available wirelessly via wireless LAN.

### Criteria

Only the "Guest" access profile can be set for the LAN guest access. You can edit the "Guest" access profile in the "Internet / Filters / Access Profiles" menu.

The access profile allows or prohibits the following activities on the guest access:

Allowed	Prohibited
Surf the web (according to the filters you specified)	Access the contents of the home network
Send and receive email	Configure settings in the FRITZ!Box user interface

## Example Configuration

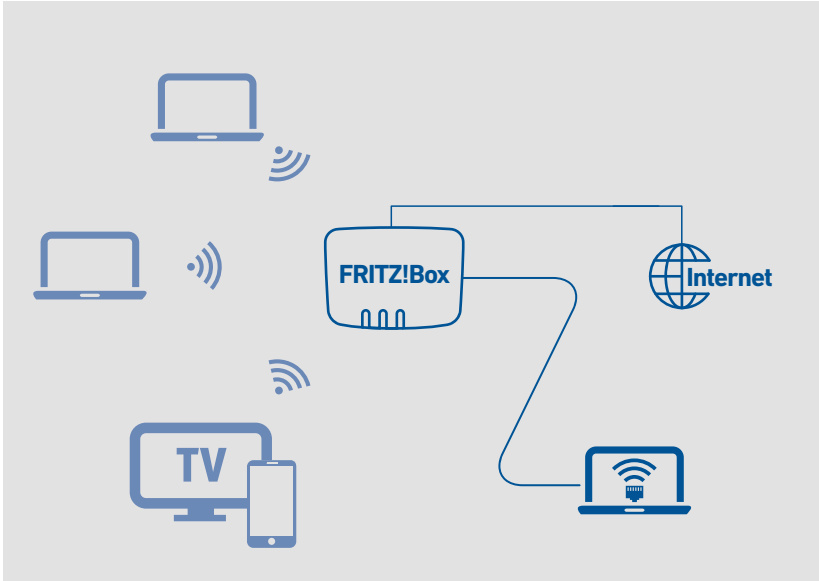

### Requirements

- You have a network cable at hand.

### Instructions: Configuring LAN guest access

1. Open the user interface, [see page 51](#).
2. Select "Home Network / Network / Network Settings".
3. For instructions, open the online help .

## Configuring Wake on LAN

### Overview

Wake on LAN is a function that allows a computer to be started via network adapter. Wake on LAN can be used with remote maintenance software, to eliminate the need to keep the computer switched on permanently. The FRITZ!Box supports Wake on LAN both for IPv4 and for IPv6 connections.

### Requirements

- The network adapter of the computer supports Wake on LAN.
- The computer is connected with the FRITZ!Box
  - via a FRITZ!Powerline device or
  - by network cable
- For access from the internet, the computer must be in standby operation.

### Instructions: Configuring Wake on LAN

1. Open the user interface, [see page 51](#).
2. Select "Home Network / Network / Network Connections / Edit Device Details".
3. For instructions, open the online help .

## Configuring USB Devices

### Overview

The FRITZ!Box has two USB ports to which you can connect various USB devices. All devices in the FRITZ!Box home network can use these USB devices jointly and simultaneously.

### Suitable USB Devices

The following USB devices can be connected to the FRITZ!Box:

- USB storage media compatible with EXT2/3/4, FAT, FAT32 or NTFS
  - flash drives
  - external hard drives
  - card readers
- USB printers
- USB all-in-one printers
- USB scanners
- USB modems
  - UMTS/HSDPA dongles
  - LTE dongles
- USB hubs

## Example Configuration

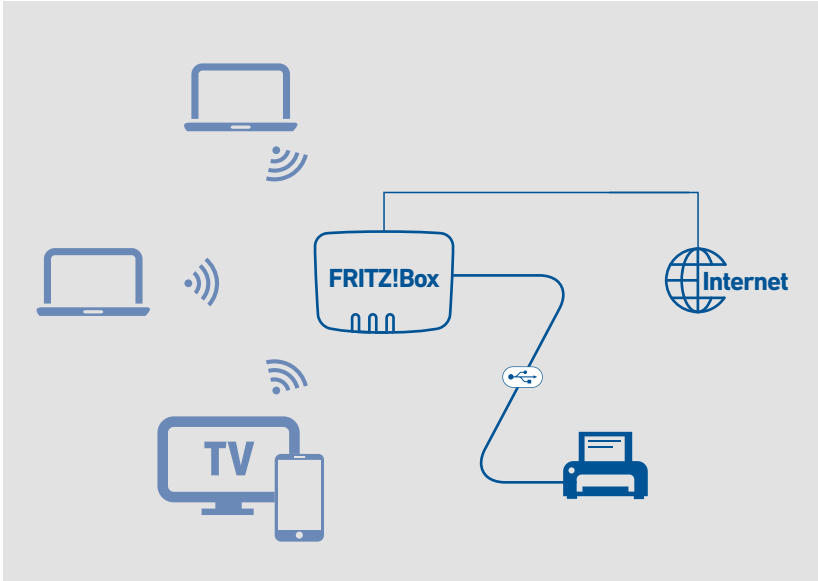

## Rules

Follow the rules below for connecting USB devices to the FRITZ!Box:

- If more than one USB device without its own power supply is connected to the FRITZ!Box, the total current consumption may not exceed a value of 900 mA. Otherwise errors on the USB devices and even damage to the FRITZ!Box may occur.
- UMTS modems can have very high power consumption. For this reason, do not operate a UMTS modem directly on the FRITZ!Box, but on an active hub with its own power supply.
- Do not conduct any updates for USB devices that are connected with the computer via the FRITZ!Box USB remote connection.

- The FRITZ!Box can not protect connected USB storage media from external influences. Voltage peaks or drops during an electrical storm can result in the loss of data. Therefore you should back up the contents of the USB storage media on a regular basis.
- Place USB hard drives as far away from the FRITZ!Box as possible in order to prevent interference with wireless radio transmission.

### Instructions: Connecting and Configuring USB Storage Media



Click “Remove Safely” before removing a USB storage medium from the FRITZ!Box. This ensures that all data transmission has been completed.

1. Connect the USB storage device to the USB port on the FRITZ!Box.

The USB storage medium will be re-indexed and you can access the stored contents.

### Configuring Access Rights for USB Storage Media

Under “System / FRITZ!Box Users” in the FRITZ!Box user interface you can specify which contents on a connected USB storage media can be accessed by each user account.

## Instructions: Configuring a USB Printer as a Network Printer (Windows 7)

A USB printer connected to the FRITZ!Box can be configured as a network printer in Windows 7:

1. Click "Start / Control Panel" and select the printer category of your operating system.
2. Click the printer icon with the right mouse button and select "Properties" or "Printer properties".
3. Switch to the "Ports" tab and click "Add Port...".
4. Double-click the "Standard TCP/IP Port" entry.
5. Click "Next" and then enter "fritz.box" in the "Printer Name or IP Address" field.
6. Enter any name you wish in the "Port name" field and click "Next".
7. Select the "Custom" option and click "Settings...".
8. Enable the "Raw" option and enter "9100" in the "Port number" field.
9. Click "OK", click "Next", and confirm with "Finish" and "Close".
10. In the "<Printer name> Properties" window, switch to the "Ports" tab.
11. Disable the "Enable bidirectional support" option and click "Apply".

The USB printer has been configured and can be used as a network printer.



## Instructions: Configuring a USB Printer as a Network Printer (Windows 8)

A USB printer connected to the FRITZ!Box can be configured as a network printer in Windows 8:

1. Press the keyboard shortcut “Windows key+X” and select “Control Panel” from the context menu.
2. Click “Hardware and Sound” and select “Devices and Printers”.
3. In the menu bar, click “Add a printer”.
4. In the “Add Printer” window, select “The printer that I want isn’t listed” and then “Next”.
5. Enable the option “Add a printer using TCP/IP address or hostname” and click “Next”.
6. Enter fritz.box in the “Hostname or IP address” field.
7. Click “Next”.
8. Click “Next” and confirm with “Finish”.

The USB printer has been configured and can be used as a network printer.

## Instructions: Configuring a USB Printer as a Network Printer (Windows 10)

A USB printer connected to the FRITZ!Box can be configured as a network printer in Windows 10:

1. Press the keyboard shortcut “Windows key+X” and select “Control Panel” from the context menu.
2. Click “Hardware and Sound” and select “Devices and Printers”.
3. In the menu bar, click “Add a printer”.
4. Click “The printer that I want isn’t listed” in the window “Add Printer” window.
5. Enable the option “Add a printer using TCP/IP address or hostname” and click “Next”.
6. Enter fritz.box in the “Hostname or IP address” field.
7. Click “Next”.
8. Select the printer manufacturer and model, and click “Next”.
9. If the “Printer Sharing” window appears, select “Do not share this printer” and click “Next”.
10. Click “Finish”.

The USB printer has been configured and can be used as a network printer.

## Instructions: Configuring a USB Printer as a Network Printer (Mac OS X 10.5 or Higher)

A USB printer connected to the FRITZ!Box can be configured as a network printer in Mac OS X version 10.5 or higher:

1. In the dock, click "System Preferences".
2. Click "Printers & Faxes".
3. Click the "+" sign.
4. Click "IP".
5. In the "Protocol:" list, select the entry "HP Jet Direct – Socket".
6. Enter fritz.box in the "Address" field.
7. In the "Use:" list, select the printer that is connected to the USB port of your FRITZ!Box.

If the printer is not displayed, you must first install the printer drivers for this device. Consult the documentation of your printer for instructions.

8. Click "Add" or "Add Port...".

The USB printer has been configured and can be used as a network printer.

## Instructions: Configuring a USB Printer in Other Operating Systems

In operating systems other than Windows or Mac OS X, configure the following settings to set up a USB printer as a network printer:

1. As the port type, select "Raw TCP".
2. Enter 9100 as the port.
3. Enter fritz.box as the printer name.

## Configuring USB 2.0 and USB 3.0

For power saving operation of the FRITZ!Box the "Home Network / USB Devices / USB Settings" menu in the user interface offers the following settings for the USB ports:

Power Mode (USB 3.0)	Green Mode (USB 2.0)
Full power: up to 3 times faster than USB 2.0	Reduced power
Increased power consumption	Reduced power consumption
Preset for the port on the back	Preset for the port on the side



Operating USB devices at a USB port in "Power Mode" may result in slower data transmission in the 2.4-GHz wireless network and poor voice quality in telephone calls with DECT cordless telephones.

The occurrence of interference depends on the quality of the USB cable used. To remedy interference, select "Green Mode" and/or switch to wireless LAN in the 5-GHz band.

## Configuring and Using the Media Server

### Overview

With the media server of the FRITZ!Box you can make photos, videos and music available to compatible playback devices. The media server can be expanded using USB storage media or USB hard disks. You can also use the media server of the FRITZ!Box to listen to web radio.

### Criteria

The FRITZ!Box detects media files automatically and makes them available in a clear playlist. You can decide yourself which media sources on the media server should be made available to the users in the home network and from the internet.



Writing large amounts of data to a storage medium connected to the FRITZ!Box can take a while. You can accelerate the process by copying the data to the storage medium on your computer first and then connecting the storage medium to the FRITZ!Box.

## Example Configuration

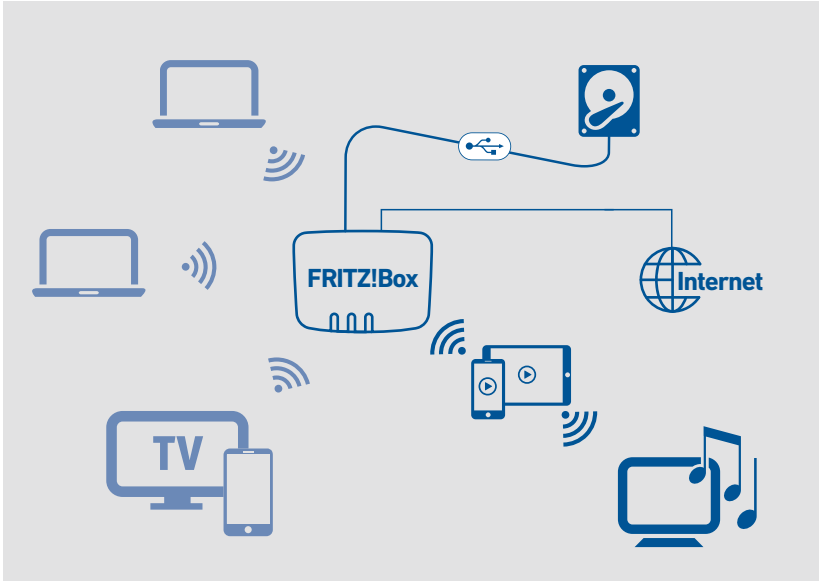

### Requirements

- The playback devices must support the UPnP AV standard.

### Instructions: Configuring and Using the Media Server

1. Open the user interface, [see page 51](#).
2. Select “Home Network / Media Server / Settings”, “Home Network / Media Server / Web Radio” or “Home Network / Media Server / Podcast”.
3. For instructions, open the online help .

## Assigning a FRITZ!Box Name

### Overview

You can assign an individual name for your FRITZ!Box in the FRITZ!Box user interface. This name is then adopted as the name of the wireless radio network (SSID).



Changing the name may make it necessary to reconfigure your wireless connections and network links.

### Consequences of Assigning a Name

The name is adopted by the following areas of your home network:

- Name of the wireless radio network (SSID)
- Name of the guest radio network (SSID)
- Name of the working group released for home network sharing
- Name of the media server
- Name of the DECT base station
- Push service sender name
- Name of your FRITZ!Box in the device overview in MyFRITZ!

### Instructions: Assigning a FRITZ!Box Name

1. Open the user interface, [see page 51](#).
2. Select "Home Network / FRITZ!Box Name".
3. For instructions, open the online help

## Controlling Smart Home Devices

### Overview

With Smart Home devices you integrate household appliances and home technology into the home network of your FRITZ!Box. This offers you the possibility of switching automated lamps and regulating the room temperature. All of the Smart Home devices can be configured and controlled in the FRITZ!Box via your computer, tablet or smartphone. With VPN remote access you can even control your Smart Home devices when you're away from home.

### Eligible Smart Home Devices

The following Smart Home devices can be registered with the FRITZ!Box at the same time and configured and controlled via the FRITZ!Box:

Type of Device	Number	Features
Smart plugs <ul style="list-style-type: none"> <li>FRITZ!DECT 200</li> <li>FRITZ!DECT 210</li> </ul>	up to 10	<ul style="list-style-type: none"> <li>Control the power supply to connected devices</li> <li>Measure the power consumption of connected devices</li> </ul>
Radiator controls <ul style="list-style-type: none"> <li>FRITZ!DECT 300</li> <li>FRITZ!DECT 301</li> <li>Comet DECT</li> </ul>	up to 12	<ul style="list-style-type: none"> <li>Control the room temperature automatically and save energy costs</li> </ul>
Button <ul style="list-style-type: none"> <li>FRITZ!DECT 400</li> </ul>	up to 10	<ul style="list-style-type: none"> <li>Switch the FRITZ!DECT 200/210 smart plugs and FRITZ!Powerline 546E</li> </ul>



Type of Device	Number	Features
Smart Home devices via HAN FUN	up to 10	<ul style="list-style-type: none"> <li>Connecting Smart Home devices from other manufacturers with the FRITZ!Box</li> <li>Switch the FRITZ!DECT 200/210 smart plugs and FRITZ!Powerline 546E</li> </ul>

### Example Configuration

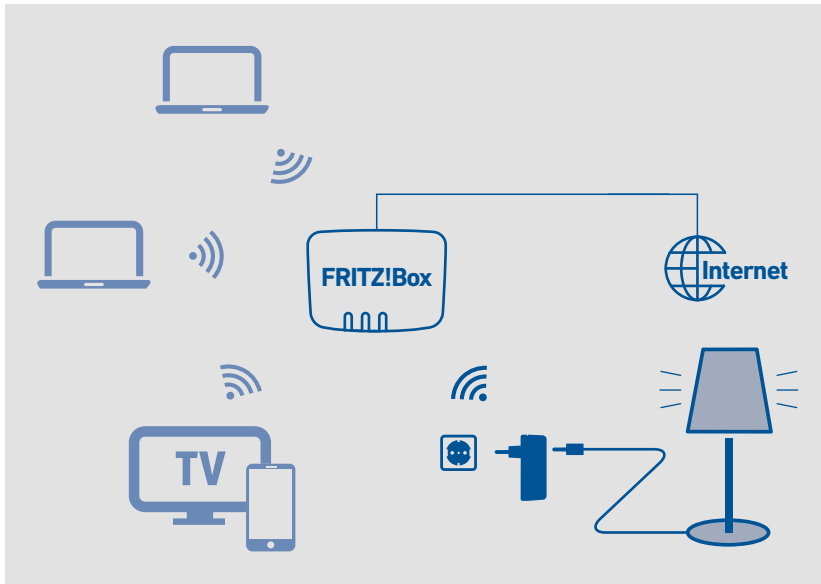

### Using Templates

With templates you can save all the settings of your Smart Home devices and apply them as needed.

Create a template with switching schedules for everyday use. For absences, for instance vacations, create a template without a switching schedule. Then, whenever you go on vacation, you can

change the settings of all Smart Home devices for the period of your absence. After you return, a simple click restores the settings for everyday operation.

## Requirements

- At least one Smart Home device is registered with the FRITZ!Box.

## Instructions: Configuring Automatic Switching

1. Open the user interface, [see page 51](#).
2. Select “Home Network / Smart Home / Edit Smart Home Device / Automatic Switching”.
3. For instructions, open the online help .

## Instructions: Setting Up a Group

1. Open the user interface, [see page 51](#).
2. Select “Home Network / Smart Home”.
3. For instructions, open the online help .

## User Interface: Wireless Menu

Wireless Menu: Settings and Features .....	156
Switching the Wireless Radio Network On and Off .....	157
Selecting the Radio Channel .....	158
Configuring Wireless Guest Access .....	160

## Wireless Menu: Settings and Features

### Overview

In the “Wireless” menu you can configure and secure a wireless radio network and a separate wireless guest access. In this menu you can also set up a schedule for your wireless radio networks and change the operating mode of the FRITZ!Box so that it can be used as a wireless repeater if needed.

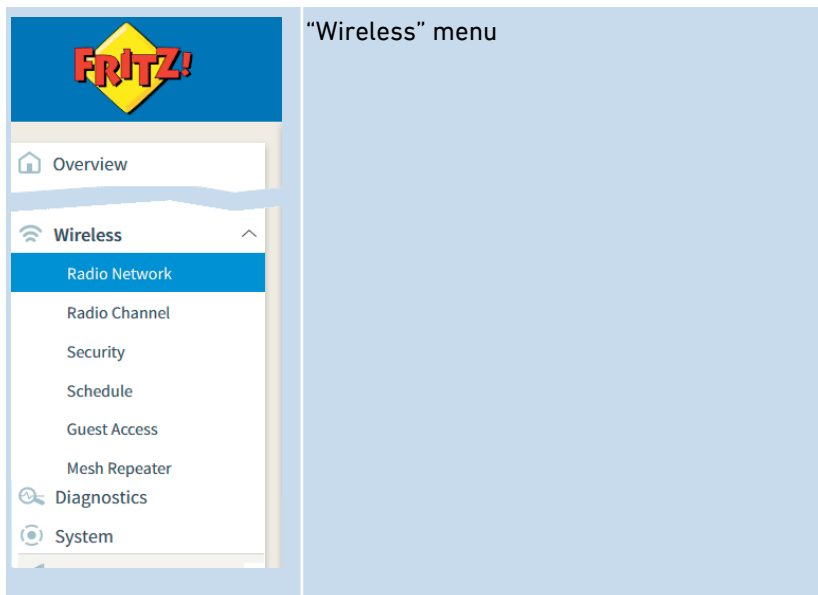

### Description of the Submenus

The online help of the user interface includes a detailed description of the submenus.

## Switching the Wireless Radio Network On and Off

### Overview

When no one is using it, you can switch off the wireless network. This way you reduce both power consumption and wireless radiation.

You can switch the wireless network on and off manually, and set up a schedule for times at which the wireless network is turned on and off automatically.

### Instructions: Switching the Wireless Network On and Off Manually

You can switch the wireless network on and off in the following ways:

- in the “Home Network / Wireless” menu of a connected FRITZ!Fon cordless telephone
- in the “Convenience Features / Wireless” menu of the MyFRITZ!App
- by keypad code using a connected telephone; see [Instructions: Switching Wireless LAN On, page 231](#) and see [Instructions: Switching Wireless LAN Off, page 232](#)

### Instructions: Switching the Wireless Network On and Off by Schedule

1. Open the user interface, see [page 51](#).
2. Select “Wireless / Schedule”.
3. For instructions, open the online help .



The FRITZ!Box schedule can be transferred to other connected AVM devices, for instance FRITZ!WLAN Repeaters and FRITZ!Powerline adapters. By default, the AVM devices adopt the settings for the wireless switching schedule from the FRITZ!Box. You can also configure a separate wireless LAN switching schedule for the connected AVM devices.

## Selecting the Radio Channel

### Overview

Wireless LAN uses the frequency ranges at 2.4 GHz and 5 GHz for transmission. Generally the FRITZ!Box automatically checks the wireless environment and selects the optimum radio channel settings. In some cases it may be necessary to adjust these radio channel settings in order to adapt the wireless radio network to the circumstances at your location.

### Comparison of the Frequency Ranges

The following table compares the 2.4-GHz and 5-GHz frequency ranges:

	2.4 GHz	5 GHz
Advantages	Greater range – supported by older and newer clients	Less busy, therefore less interference
Disadvantages	Subject to heavy use, therefore often lots of interference	Lower range – only supported by newer clients
Recommendation	Use for applications that require a low to normal throughput rate (for instance, reading and writing email).	Use for applications that rely on a steady, high throughput rate (for instance, streaming).

### Wireless Auto Channel

With the “Set radio channel settings automatically” (wireless auto channel) feature, the FRITZ!Box automatically searches for the channel subject to the least interference. This process takes into consideration interference from radio networks in the vicinity (wireless access points) and potential sources of interference (for instance baby moni-

tors, microwave ovens). Should problems with interference persist despite this function, try to identify the source of interference and eliminate it.

### Switching Frequency Bands Spontaneously (Band Steering)

To improve data transmission, the FRITZ!Box can automatically switch the frequency band used by dual-band wireless devices. For this the registered wireless devices are controlled so that they log in to the less busy frequency band, and thus take better advantage of the wireless spectrum available on both frequency bands.

### Instructions: Adjusting the Radio Channel Settings Manually

1. Open the user interface, [see page 51](#).
2. Select "Wireless / Radio Channel".
3. For instructions, open the online help .

## Configuring Wireless Guest Access

### Overview

In addition to its wireless network, the FRITZ!Box can provide a second, independent wireless guest network. You can make this wireless guest network available to your guests. Then your guests can log in with the wireless guest network on their own smartphones, tablets, laptops or other network devices, without being able to access the FRITZ!Box home network.

### Wireless Guest Access as a Private or Public Hotspot

The wireless guest access can be configured as a private or public hotspot.

With a private wireless guest access – a private hotspot – you can provide houseguests with an internet connection of their own. For this you assign the private hotspot its own wireless network key and guest wireless network name (SSID). You can provide the access information to your guests via QR code or print it out for them.

If you run a shop, a practice or other public premises, you can offer your guests the wireless guest access as a public hotspot. You can assign the public hotspot its own guest radio network name (SSID). Because access is not encrypted, no wireless network key is required.

### The “Guest” Access Profile

Wireless devices that register with the wireless guest network are automatically assigned the “Guest” access profile.



The following activities are allowed or prohibited in the preconfigured “Guest” access profile:

Allowed	Prohibited
Surf the web (independent of any configured filter lists: blacklist or whitelist)	Access the contents of the home network
Send and receive email	Configure settings in the FRITZ!Box user interface

The “Guest” access profile can be edited in the “Internet / Filters / Access Profiles” menu; [see page 92](#).

The filters configured in the “Guest” access profile determine which websites your guests are allowed to visit. The filters can be edited in the “Internet / Filters / Lists”; [see page 94](#).

### Settings for the Wireless Guest Access

You can configure the following settings for the wireless guest access as a private or public hotspot:

Setting	Content and Function
FRITZ!Box push service	Notification about devices registering with and deregistering from your FRITZ!Box by email; <a href="#">see page 179</a> .
Restrict use	Guests are restricted to surfing the internet, and sending and receiving email.
Captive portal	With a captive portal you can inform guests about the terms of use you defined and then route them to your website.

Setting	Content and Function
Visibility in the guest network	Specify whether or not the users' wireless devices can reach each other in the network of the wireless guest access.
Switch off automatically	The wireless guest access is disabled automatically after a time range you specify, or whenever the last guest has logged off.
QR code	The FRITZ!Box automatically generates a QR code for the wireless guest access. Then your guests can log in conveniently by scanning this code.

### Switching the Wireless Guest Access On and Off

The wireless guest access can be switched on and off in the following ways:

- Smartphone or tablet
  - MyFRITZ!App (iOS)
  - MyFRITZ!App 2 (Android)
  - FRITZ!App WLAN
- FRITZ!Fon: "Home Network / Smart Home / Wireless" menu
- FRITZ!Box user interface
  - <http://myfritz.box>: "Convenience Features"
  - <http://fritz.box>: "Wireless / Guest Access" menu and Time Control in the "Guest" access profile

## Example Configuration

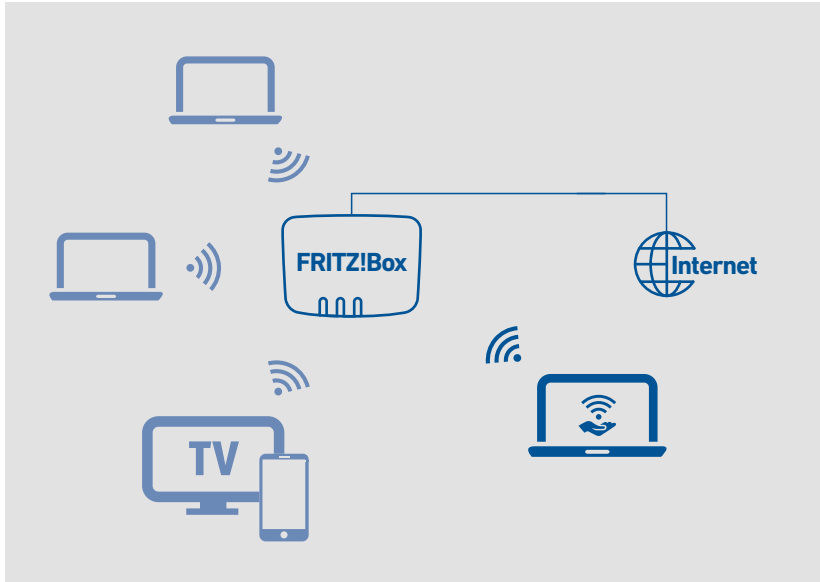

### Instructions: Configuring wireless guest access

1. Open the user interface, see page 51.
2. Select "Wireless / Guest Access".
3. For instructions, open the online help .

## User Interface: DECT Menu

DECT Menu: Settings and Features .....	165
Enabling DECT Eco.....	166
Allowing Non-encrypted Connections .....	167
Switching DECT On and Off.....	168

## DECT Menu: Settings and Features

### Overview

The “DECT” menu contains the settings to configure the DECT base station integrated in the FRITZ!Box.

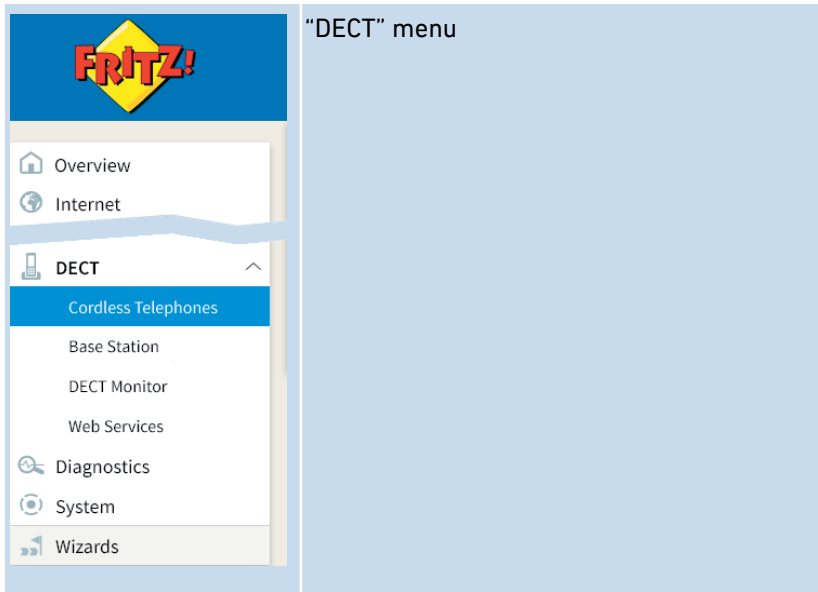

### Description of the Submenus

The online help of the user interface includes a detailed description of the submenus.

## Enabling DECT Eco

### Overview

DECT Eco allows DECT radio transmission to be switched off during standby operation. DECT Eco reduces DECT radiation, but does not save any electricity.

### How It Works

A telephone is on standby operation when you are not making any calls, not using any other features, and not pressing any buttons. When all registered cordless telephones are in standby operation, the DECT radio network of the FRITZ!Box and the telephones is switched off. As soon as a call arrives or you press a key on a cordless telephone, the DECT radio network is switched back on.

### Requirements

- In the user interface, the “DECT Eco supported” option must be displayed for each telephone under “DECT / DECT Monitor”.
- The following devices may not be registered with the FRITZ!Box: FRITZ!DECT devices with an outlet switch, FRITZ!DECT Repeater, a FRITZ!Box in DECT repeater mode.

### Instructions: Enabling DECT Eco

1. Open the user interface, [see page 51](#).
2. Select the “DECT / Base Station” menu.
3. For instructions, open the online help .

## Allowing Non-encrypted Connections

### Overview

The FRITZ!Box is preconfigured to allow only authenticated and encrypted DECT connections. In order to use DECT repeaters from other manufacturers that do not allow encrypted connections, you can allow non-encrypted connections.

### Consequences of Non-encrypted Connections

The following FRITZ!Box features cannot be used if you allow non-encrypted connections:

- Registration of FRITZ!DECT Repeater or FRITZ!Box in DECT repeater mode
- DECT Eco
- HD telephony
- Own ring tones for FRITZ!Fon
- Playback of web radio or podcast with FRITZ!Fon
- Display of background image or photos of callers on FRITZ!Fon
- Rendering of audio files from the FRITZ!Box media server with FRITZ!Fon

### Requirements

DECT settings can be changed only if the following prerequisite is met:

- At least one DECT cordless telephone is registered with the FRITZ!Box.

### Instructions: Allowing Non-encrypted DECT Connections

1. Open the user interface, [see page 51](#).
2. Select the "DECT / Base Station" menu.
3. For instructions, open the online help .

## Switching DECT On and Off

### Overview

DECT is switched on automatically whenever you register a DECT device with the FRITZ!Box and switched off when you deregister all DECT devices. You can also switch off DECT in the user interface. Then the registered DECT devices will lose their connections to the FRITZ!Box, but remain registered with it. When you switch DECT back on, the connections will be restored.

### Instructions: Switching DECT On and Off

1. Open the user interface, [see page 51](#).
2. Select the “DECT / Base Station” menu.
3. Enable or disable the “DECT base station enabled” checkbox.
4. Click “Apply”.



# User Interface: Diagnostics Menu

Diagnostics Menu: Settings and Features.....	170
Starting the Function Diagnostics .....	171
Using Security Diagnostics .....	173



## Diagnostics Menu: Settings and Features

### Overview

The “Diagnostics” menu presents an overview of the functional status of your FRITZ!Box, your home network, and the connection to the internet. You also get an overview of all security-relevant settings of your FRITZ!Box. At a single glance it shows which ports are opened, which users are logged in and which wireless devices are connected.

In the case of an error, the results of the function and security diagnostics can be saved and sent to the AVM Support team.

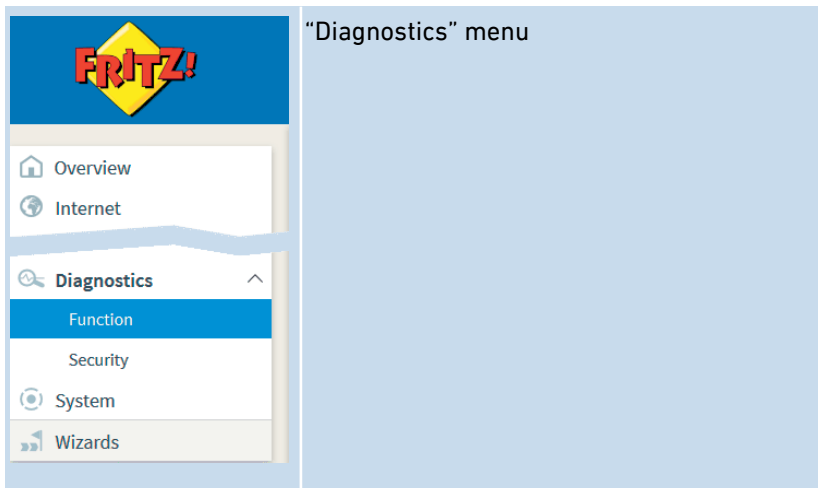

### Description of the Submenus

The online help of the user interface includes a detailed description of the submenus.

## Starting the Function Diagnostics

### Overview

With the function diagnostics you can get an overview of the functional status of your FRITZ!Box and its internet connection, and of your home network as well. In the case of an error the diagnostics results can help you localize and remedy any problems.

### Areas of Diagnostics

The following areas are checked:

Area	Checkpoint / Status
FRITZ!Box 6591 Cable	<ul style="list-style-type: none"> <li>Name of the FRITZ!Box</li> <li>FRITZ!Box version</li> <li>Whether FRITZ!OS is up to date</li> </ul>
Registration	Method for logging in to the FRITZ!Box user interface
LAN	<ul style="list-style-type: none"> <li>Allocation of LAN ports</li> <li>Power settings on LAN ports</li> </ul>
Wireless	<ul style="list-style-type: none"> <li>Wireless LAN frequency band enabled/disabled with wireless function</li> <li>Number of wireless LAN devices connected</li> <li>Security settings</li> </ul>
DECT	<ul style="list-style-type: none"> <li>DECT enabled/disabled</li> <li>Number of DECT devices connected</li> </ul>
USB devices	<ul style="list-style-type: none"> <li>Number of storage media connected</li> <li>Number of partitions</li> <li>Connected printers</li> </ul>

Area	Checkpoint / Status
Internet connection	<ul style="list-style-type: none"> <li>• IPv4 connection active since/not active</li> <li>• IPv6 connection active since/not active</li> <li>• Current IP address</li> </ul>
Telephone numbers	How many and which numbers assigned
MyFRITZ!	<ul style="list-style-type: none"> <li>• Status of MyFRITZ! activation</li> <li>• MyFRITZ! account email address</li> </ul>
Home network	<ul style="list-style-type: none"> <li>• Number of network devices connected with the FRITZ!Box at present or at an earlier point in time</li> <li>• Number of network devices online</li> </ul>
Smart Home	Number of Smart Home devices
Wireless environment	Wireless LAN frequency band, with number of wireless radio networks on the same or an adjacent channel

### Instructions: Starting Function Diagnostics

1. Open the user interface, [see page 51](#).
2. Select "Diagnostics / Function".
3. For instructions, open the online help .

## Using Security Diagnostics

### Overview

By means of the security diagnostics you get an overview of all security-relevant settings of your FRITZ!Box. At a glance you can see whether the latest FRITZ!OS is installed, which ports are open, which users are logged in or off the FRITZ!Box, which wireless devices with which properties are connected to the FRITZ!Box and much more.

### Security Diagnostics Test Points

The following areas are checked:

Area	Checkpoint / Status
FRITZ!OS	<ul style="list-style-type: none"> <li>FRITZ!Box version</li> <li>Whether FRITZ!OS is up to date</li> </ul>
Registration	Method for logging in to the FRITZ!Box user interface
Internet connection	<ul style="list-style-type: none"> <li>Ports opened on the FRITZ!Box</li> <li>Protocols used on these ports</li> <li>port sharing for home network devices to the internet</li> <li>Filters for internet access</li> </ul>
MyFRITZ!	<ul style="list-style-type: none"> <li>Status of MyFRITZ! activation</li> <li>MyFRITZ! account email address</li> <li>Registration link for MyFRITZ!</li> <li>Overview of MyFRITZ! sharing for access from the internet</li> </ul>
Outgoing filters	Overview of active filters for access from the internet

Area	Checkpoint / Status
Wireless	<ul style="list-style-type: none"> <li>• Properties and security-relevant settings for access to the wireless network and wireless guest access</li> <li>• Names of registered and known wireless devices</li> </ul>
Telephony	<ul style="list-style-type: none"> <li>• Functions and properties of the DECT base station of the FRITZ!Box</li> <li>• Call handling like call diversion settings, premium numbers, settings for international calls and security-relevant connection settings</li> <li>• IP telephone settings: connected with the FRITZ!Box directly or via FRITZ!App Fon</li> </ul>
FRITZ!Box Users	<ul style="list-style-type: none"> <li>• All FRITZ!Box users and their rights to access FRITZ!Box contents, for the FRITZ!Box home network and for access from the internet</li> <li>• Time at which the FRITZ!Box last logged in and the IP address it used to do so</li> </ul>
FRITZ!NAS	<p>Access rights to the FRITZ!Box storage media with the following details:</p> <ul style="list-style-type: none"> <li>• which user has access to which storage media</li> <li>• which rights (write and read) are included</li> <li>• whether access is permitted only via the home network, or also from the internet.</li> </ul>

### Instructions: Using Security Diagnostics

1. Open the user interface, see page 51.

2. Select "Diagnostics / Security".
3. For instructions, open the online help .

## User Interface: System Menu

System Menu: Settings and features .....	177
Configuring Push Services .....	179
Selecting Signaling of the "Info" LED .....	181
Locking Buttons.....	182
Configuring FRITZ!Box Users and FRITZ!Box Password .....	183
Saving Settings .....	188
Loading Settings .....	189
Restarting the FRITZ!Box .....	190
Updating FRITZ!OS .....	191
Restoring Factory Settings .....	196
Changing the Language of the User Interface .....	198
Changing Regional Options.....	199
Adjusting the Time Zone.....	200



## System Menu: Settings and features

### Overview

The “System” menu shows you all system-relevant events and presents an “Energy Monitor” showing information about the power consumption of your FRITZ!Box. Various notification services inform you about the activities of the FRITZ!Box and assist you in saving your passwords and FRITZ!Box settings.

In addition to allocating rights in the user administration, the “System” menu entries also allow the settings of the FRITZ!Box to be saved and restored.

In the “Update” menu you can also specify how the operating FRITZ!OS system is kept up to date.

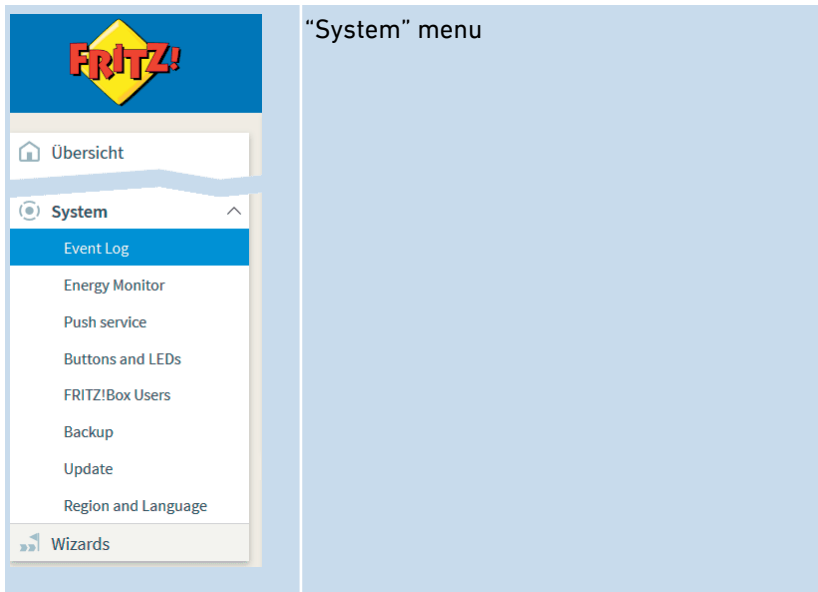

## Description of the Submenus

The online help of the user interface includes a detailed description of the submenus.

## Configuring Push Services

### Overview

Various push services are available in the user interface under “System / Push Service”. Push services are notification services that inform you about the activities of your FRITZ!Box and assist you in saving your passwords and FRITZ!Box settings. With the push services you can have email sent to you at regular intervals informing you about the latest connections, usage and configuration of your FRITZ!Box.

### Available Push Services

You can request push service mails to be notified about the following activities by the FRITZ!Box:

Push Service	Function
FRITZ!Box Info	Sends you regular email messages with data on FRITZ!Box usage and connections
Answering machine	Forwards messages recorded on the FRITZ!Box answering machines to the specified email address
Calls	Sends you email when calls arrive – either only for missed calls, or for all calls
Smart Home	Sends you the status of a Smart Home device regularly or when important events occur
Wireless guest access	Sends a message whenever devices register with or deregister from the wireless guest access
Fax function	Forwards your faxes by email and also saves them to a storage location you defined

Push Service	Function
New FRITZ!OS	Notifies you whenever a new FRITZ!OS version is available for your FRITZ!Box
Save settings	Saves the settings of the FRITZ!Box to a backup file before each update and every time the factory settings are restored, and forwards this file by email
Forgot password	Sends you an access link to the specified email address if you have forgotten your password
Current IP address	Sends the IP address assigned by the internet service provider every time the internet connection is established
Change notice	Sends you an email every time changes are made to a FRITZ!Box setting or when potentially security-relevant events occur.

### Instructions: Enabling Push Service

1. Open the user interface, [see page 51](#).
2. Select "Overview / Wizards".
3. For instructions, open the online help .

### Instructions: Configuring Push Service

1. Open the user interface, [see page 51](#).
2. Select "System / Push Service".
3. For instructions, open the online help .

## Selecting Signaling of the “Info” LED

### Overview

The LED “Info” signals various events. Some events are preset and configured permanently; [see LEDs, page 24](#). In addition to this, the “Info” LED can be assigned to display another event of your choice.

### Example 1

You would like to be notified about new messages on the answering machine. The “Info” LED flashes when there are new messages on the FRITZ!Box answering machine. The LED stops flashing as soon as all new messages have been heard.

### Example 2

You would like to be notified when the data or time included in your internet package, stipulated in the “Internet / Online Monitor / Online Meter”, has been exhausted. The “Info” LED will then flash when the configured volume has been exceeded.

### Instructions: Selecting the Signaling of the Info LED

1. Open the user interface, [see page 51](#).
2. Select “System / Buttons and LEDs / “Info” Display.”
3. For instructions, open the online help .

## Locking Buttons

### Overview

You can lock the buttons on the FRITZ!Box. Locking the buttons prevents the settings for your FRITZ!Box or your home network from being changed unintentionally or without authorization.

### Instructions: Locking the Buttons on the FRITZ!Box

1. Open the user interface, [see page 51](#).
2. Select "System / Buttons and LEDs / Keylock".
3. For instructions, open the online help .

## Configuring FRITZ!Box Users and FRITZ!Box Password

### Overview

When you open the user interface of your FRITZ!Box, you will be prompted to log in. This login serves to keep your FRITZ!Box secure and protects access to the user interface. You have two options for logging in to your FRITZ!Box:

- Login with a general FRITZ!Box password that grants general access to all areas of the FRITZ!Box. This login method is the default setting in the FRITZ!Box.
- Login with a personalized FRITZ!Box user account, with which access to the FRITZ!Box can be configured differently for each user.

### FRITZ!Box Password

A general FRITZ!Box password is already configured for your FRITZ!Box upon delivery. The preconfigured FRITZ!Box password for your FRITZ!Box is printed on the FRITZ!Box service card “FRITZ!Notes” and on the type label on the bottom of the housing of your FRITZ!Box.

With the FRITZ!Box password you can specify the following:

- Every user who logs in with the general FRITZ!Box password has the right to access all contents and settings on the FRITZ!Box.
- Login using the FRITZ!Box password is possible only within the FRITZ!Box home network.

### FRITZ!Box users

In order to control access to your FRITZ!Box for each person individually, you can set up FRITZ!Box users. FRITZ!Box users are individual authorizations to access and use the FRITZ!Box, which are linked with a personalized user account.

A FRITZ!Box user account is set up with a user name and a password. An email address is not required for a FRITZ!Box user account, but is recommended for notifications.

With FRITZ!Box user accounts you have the following options:

- If you create a FRITZ!Box user account for a person, then that person is granted rights for selected areas and functions of the FRITZ!Box.
- Every FRITZ!Box user logs in with their own user name and a unique password.
- Login using a FRITZ!Box account is possible from the home network of the FRITZ!Box and, with the appropriate rights, also via the internet.
- You can set up as many as 18 FRITZ!Box user accounts.

You can configure the following rights for each FRITZ!Box user:

- Access the FRITZ!Box from the internet
- View and edit FRITZ!Box settings
- View and listen to voice messages, faxes and FRITZ!App Fon call list
- Control Smart Home devices
- Access selected network storage (NAS)
- Establish a VPN connection to the FRITZ!Box



## FRITZ!Box Password or FRITZ!Box Users?

You can log in to the user interface of your FRITZ!Box with a FRITZ!Box password or via a FRITZ!Box user account. Here is an overview of the differences:

	FRITZ!Box Password	FRITZ!Box users
Registration	For login you use a preconfigured FRITZ!Box password or specify a FRITZ!Box password yourself.	There are personalized user accounts.  Every FRITZ!Box user logs in with their own user name and a unique password.
Scope of access	Every user who logs in with the FRITZ!Box password has the right to access all contents and settings on the FRITZ!Box.	The user account specifies which contents and settings of the FRITZ!Box each FRITZ!Box user is allowed to access.
Kind of access	Login to the user interface is permitted from devices located in the home network of the FRITZ!Box.	Login is possible from the home network of the FRITZ!Box and, with the appropriate rights, also via the internet.

## Rules for User Names and Passwords

Comply with the following rules for creating user names and setting passwords:

- For FRITZ!Box users, select a user name that begins with a letter from a to z in upper or lower case and has a maximum of 32 characters; [see Characters Allowed for Passwords and User Names, page 186.](#)

- Select a password with at least twelve characters, which includes capitals and lower-case letters as well as numerals and special characters; see [Characters Allowed for Passwords and User Names, page 186](#).
- Configure the “Forgot password” push service. When you have forgotten a password, the FRITZ!Box sends an access link to the email address you specified. Using this link you can set a new password.



If you lose your FRITZ!Box password and did not configure the “Forgot password” push service, you will have to restore the factory settings to the FRITZ!Box and reconfigure all of your personal settings for your internet connection, your telephone system and your home network.

### Characters Allowed for Passwords and User Names

Characters	Allowed for	Not Allowed for
Letters of the Latin alphabet (a-z) in lower case and upper case	user names, passwords	
Numerals (0-9)	user names, passwords	
spaces	user names, passwords	
Umlauts (ä, ö, ü)		user names, passwords
letter ß		user names, passwords

Characters	Allowed for	Not Allowed for
special characters: - _ , .	user names, passwords	
Special characters: ! " # \$ % & ' ( * ) + / : ; < = > ? @ [ \ ] ^ _ {   } ~	passwords	user names
special characters: § ´		user names, passwords

### Instructions: Configuring a FRITZ!Box Password

1. Open the user interface, [see page 51](#).
2. Select "System / FRITZ!Box Users / Login to Home Network".
3. For instructions, open the online help .

### Instructions: Configuring FRITZ!Box Users

1. Open the user interface, [see page 51](#).
2. Select "System / FRITZ!Box Users / Users".
3. For instructions, open the online help .

## Saving Settings

### Overview

You can save all of the settings made in your FRITZ!Box to a backup file. Using this file you can save time on future configurations:

- You can restore the saved settings in your current FRITZ!Box.
- You can load the saved settings into a FRITZ!Box of the same model.
- You can load the saved settings into a FRITZ!Box of another model.

### Instructions: Saving Settings Automatically

1. Open the user interface, [see page 51](#).
2. Select “System / Push Service / Push Services”.
3. For instructions, open the online help .

### Instructions: Saving Settings Manually

1. Open the user interface, [see page 51](#).
2. Select “System / Backup / Save”.
3. For instructions, open the online help .

## Loading Settings

### Overview

FRITZ!Box settings you have previously saved can be restored.

- You can restore settings saved in your current FRITZ!Box.
- You can load the saved settings into a FRITZ!Box of the same model.
- You can load the saved settings into another FRITZ!Box of a different model.

When restoring your FRITZ!Box settings, you can choose whether to restore all settings, or only certain selected ones.

### Instructions: Loading Settings

1. Open the user interface, [see page 51](#).
2. Select "System / Backup / Restore".
3. For instructions, open the online help .

## Restarting the FRITZ!Box

### Overview

A restart of your FRITZ!Box may be necessary if the FRITZ!Box no longer reacts correctly, or if internet connections can no longer be established for no apparent reason. You can perform a restart directly on the FRITZ!Box or via the FRITZ!Box user interface.

### Consequences of Restarting

Restarting the FRITZ!Box has the following consequences:

- The FRITZ!Box is reinitialized.
- Events in the “System / Event Log” menu are deleted.
- Settings and adjustments you made in the FRITZ!Box remain intact.

To delete all of the settings you made in the FRITZ!Box, see [Restoring Factory Settings, page 196](#).

### Instructions: Restarting the FRITZ!Box on the Device

1. Remove the power adapter of the FRITZ!Box from the electrical outlet.
2. Wait 5 seconds.
3. Plug the power adapter back in to the outlet.

Restarting the FRITZ!Box takes about 2 minutes.

### Instructions: Restarting the FRITZ!Box from the User Interface

1. Open the user interface, see [page 51](#).
2. Select “System / Backup / Restart”.
3. For instructions, open the online help .

## Updating FRITZ!OS

### Overview

FRITZ!OS is the operating system of the FRITZ!Box. AVM regularly makes new versions of FRITZ!OS available for your FRITZ!Box, free of charge. Updates contain further developments and often new features for your FRITZ!Box.



Always install the latest FRITZ!OS version on all FRITZ! products in your FRITZ!Box home network. This keeps your FRITZ! products up to date and ensures optimum synchronization of all devices in your home network. Regular updates also protect from hacker attacks.

If you received your FRITZ!Box from your cable provider, then you FRITZ!OS updates will be installed automatically by your provider. The features and wizards for updates are not available in the FRITZ!Box user interface.

### Instructions: Updating FRITZ!OS via Wizard



Interrupting a FRITZ!OS update could damage your FRITZ!Box. Do not clear the connection between FRITZ!Box and the computer during a FRITZ!OS update, and do not unplug the power cord.

Perform the update as follows:

1. Open the user interface, [see page 51](#).
2. On the "Overview" page, select the "Wizards" menu.
3. Start the "Update" wizard.  
The "System / Update / FRITZ!OS Version" page is opened.

4. Click the “Find New FRITZ!OS” button.  
The wizard checks whether a FRITZ!OS update is available for your FRITZ!Box.  
If the wizard finds an update, the version number of the new FRITZ!OS is displayed. Click on the link under the FRITZ!OS version to view information about further developments and new functions contained in the FRITZ!OS update.
5. To install an update, click the “Start Update” button.  
The FRITZ!OS update starts and the “Info” LED starts flashing.  
When the “Info” LED stops flashing, the FRITZ!OS update is finished.

### Instructions: Updating FRITZ!OS Manually

In some cases it is not possible to perform an automatic update. Then you have the option of performing an update manually.



Interrupting a FRITZ!OS update could damage your FRITZ!Box'. Do not clear the connection between FRITZ!Box and the computer during a FRITZ!OS update, and do not unplug the power cord.

Perform the manual update as follows:

1. Enter the following address in the web browser:  
<ftp.avm.de/fritzbox>
2. Switch to the folder for your FRITZ!Box model, then to the sub-folder “firmware”, and then to the folder with your language of choice. The complete model name of your FRITZ!Box is shown in the user interface on the “Overview” page and is also printed on the sticker on the bottom of the housing.
3. Download the latest FRITZ!OS file for your FRITZ!Box with the file extension “.image” to the computer.
4. Open the user interface, [see page 51](#).
5. Enable the advanced view; [see page 58](#).
6. Select “System / Update / FRITZ!OS File”.



7. Click the "Save Settings" button to save the current settings of your FRITZ!Box on your computer and save the export file on your computer. Using this file you can restore the settings of your FRITZ!Box as needed.
8. Click the "Browse..." button and choose the file with the new FRITZ!OS you already downloaded and saved on your computer.
9. Click "Start Update".

The FRITZ!OS update begins and the "Info" LED starts flashing. The FRITZ!OS update is complete when the "Info" LED stops flashing.

### Information on the Automatic Update Function

FRITZ!Box searches for updates periodically. A new version of FRITZ!OS can contain improvements, bug fixes and important security updates, as well as significant new functions.



For secure, reliable use of your FRITZ!Box we recommend updating the FRITZ!OS regularly.

With the automatic update function you will never miss a software update for your FRITZ!Box and will be able to use new features right away. In the "System / Update / Automatic Update" menu you can specify whether every new version of FRITZ!OS should be installed automatically, or only critical updates, such as security updates, or whether you would rather just be informed about a new version of FRITZ!OS.

The "Automatic Update" function offers you the following methods:

Procedure	Description
Notify about new FRITZ!OS versions	<ul style="list-style-type: none"> <li>• The FRITZ!Box indicates that a new version of FRITZ!OS is available on the "Overview" page.</li> <li>• You start the update yourself; <a href="#">see page 191</a>.</li> </ul>

Procedure	Description
<p>Notify me about new versions of FRITZ!OS and install necessary updates automatically (recommended)</p>	<ul style="list-style-type: none"> <li>• The FRITZ!Box indicates that a new version of FRITZ!OS is available on the "Overview" page. You start the update yourself; <a href="#">see page 191</a>.</li> <li>• Updates which AVM regards as necessary for continued secure and reliable operation (for instance, security updates) will be installed automatically.</li> <li>• The FRITZ!Box selects a suitable time for the update, generally at night.</li> <li>• During the installation all internet and telephony connections will be interrupted briefly.</li> </ul>
<p>Notify me about new versions of FRITZ!OS and install new versions automatically</p>	<ul style="list-style-type: none"> <li>• The FRITZ!Box indicates that a new version of FRITZ!OS is available on the "Overview" page.</li> <li>• Every new version of FRITZ!OS will be installed automatically.</li> <li>• The FRITZ!Box selects a suitable time for the update, generally at night.</li> <li>• During the installation all internet and telephony connections will be interrupted briefly.</li> </ul>

### Instructions: Configuring Automatic Updates

1. Open the user interface, [see page 51](#).
2. Select "System / Update / Automatic Update".
3. For instructions, open the online help .

### Instructions: Disabling Automatic Updates

1. Open the user interface, [see page 51](#).

2. Select "Internet / Account Information / AVM Services".
3. For instructions, open the online help .

## Restoring Factory Settings

### Overview

You can restore factory settings to the FRITZ!Box.

### Application Scenario

Resetting makes sense in the following cases:

- You forgot your password and can no longer access the user interface of your FRITZ!Box.
- The FRITZ!Box does not work any more (for instance, due to improper settings).
- The FRITZ!Box is to be passed on to an outside party for repair.
- The FRITZ!Box is to be resold to another user.
- The FRITZ!Box is to be disposed of.

### Consequences of Resetting

Resetting the FRITZ!Box has the following effects:

- All of the settings you made in the FRITZ!Box will be deleted.
- The internal memory of the FRITZ!Box is deleted. In addition to contents on FRITZ!NAS, messages received on the answering machine and faxes will be discarded.
- The network key of the factory settings will be activated again.
- The name of the wireless radio network (SSID) will be reset.
- The IP configuration of the factory settings will be restored.

### Preparation

If you would like to restart operation of the FRITZ!Box after restoring factory settings, make the following preparations:

- Save your FRITZ!Box settings; [see Saving Settings, page 188](#).

## Instructions: Restoring factory settings



When the factory settings are restored, all of the settings you made in the FRITZ!Box are deleted.

1. Open the user interface, [see page 51](#).
2. In the FRITZ!Box user interface, select the “System / Backup” menu.
3. Select the “Factory Settings” tab.
4. Click the “Load Factory Settings” button.

The FRITZ!Box is reset to its factory settings. All data have been deleted. The is reset to its factory settings. All data have been deleted.





If you intend to restart operation of the FRITZ!Box, we recommend updating the FRITZ!OS of the FRITZ!Box; [see page 191](#).

## Changing the Language of the User Interface

### Overview

You have the option to change the language of the user interface. You can choose between English, French, German, Italian, Polish, and Spanish.

### Instructions: Changing the Language Setting



1. For instructions, open the online help .
2. Select "System / Region and Language / Language".
3. For instructions, open the online help .

## Changing Regional Options

### Overview

The FRITZ!Box is optimized to make telephone calls in various countries. With the regional options you specify the country in which you use your FRITZ!Box for telephone calls. This way you ensure that the FRITZ!Box adjusts optimally to the telephony functionality of the country in which it is used.

### Instructions: Changing Regional Options

1. For instructions, open the online help .
2. Select "System / Region and Language / Regional Options".
3. For instructions, open the online help .

## Adjusting the Time Zone



### Overview

By default, the FRITZ!Box automatically sets the time zone when it connects to the internet. However, you can also set the time zone where you use the FRITZ!Box manually.



For all features of the FRITZ!Box to work smoothly, the FRITZ!Box must always be set to the local time zone where it is located.

### Instructions: Adjusting the Time Zone

1. For instructions, open the online help .
2. Select "System / Region and Language / Time Zone".
3. For instructions, open the online help .



# User Interface: Wizards Menu

Using Wizards ..... 202



## Using Wizards

### Overview

Wizards guide you step by step through the most important FRITZ!Box functions. All settings options are commented on in detail. Follow the wizard's instructions in each window and configure your settings.



When you cancel a wizard, any entries you made during the course of using the wizard are discarded.

### Range of Functions

The following wizards assist you in step-by-step configuration:

Wizard	Function
Manage Telephony Devices	Connecting and configuring the following devices: <ul style="list-style-type: none"> <li>• telephones</li> <li>• answering machine</li> <li>• fax machines</li> <li>• ISDN telephone systems (PBXs)</li> <li>• cordless (DECT) telephones</li> </ul>

Wizard	Function
Manage Your Telephone Numbers	Adding and editing telephone numbers
Configure Internet Connection	Configuring and checking your internet connection
Check the Status of the FRITZ!Box	Diagnostics of the functional status of your FRITZ!Box, its internet connection and the home network connection to the
Security	<ul style="list-style-type: none"> <li>• Diagnostics of FRITZ!Box settings that regulate access to the FRITZ!Box from the internet or in the home network</li> <li>• Warnings about potentially insecure settings</li> </ul>
Save and Restore Settings	Saving and restoring the FRITZ!Box settings
Update	Checks whether a new version of FRITZ!OS is available for your FRITZ!Box
Configure Push Service	Configuring push services (automatic email sent with status and usage data)

### Instructions: Starting Wizards

1. Open a web browser.
2. Enter <http://fritz.box> in the address field.
3. Click the "Wizards" menu.
4. Start the wizard of your choice with a mouse click.
5. Follow the instructions the wizard displays on the screen.

# FRITZ!NAS

FRITZ!NAS Features .....	205
Expanding FRITZ!NAS Storage.....	207
Displaying FRITZ!NAS in a File Manager .....	208
Saving FRITZ!NAS Storage .....	209



## FRITZ!NAS Features

### Overview

With FRITZ!NAS you can display the data on the storage media of your FRITZ!Box in a clearly arranged interface. All participants in the FRITZ!Box home network can start FRITZ!NAS in a web browser and use it as a platform to access music, images, videos and documents in the FRITZ!Box memory.

The FRITZ!Box storage is composed of:

- internal memory
- configured online storage
- connected USB storage media

### Areas of the FRITZ!NAS User Interface

No.	Area	Function
1	Toolbar	<ul style="list-style-type: none"> <li>• Upload and download files</li> <li>• Edit folders and folder contents</li> <li>• Permit access (folders and files released for sharing from the internet)</li> <li>• View (list and tile view)</li> <li>• Refresh</li> </ul>
2	Search mask	Search for file names
3	Path	Path name
4	Display area	Display of all folders and folder contents

### Requirements

- Web browser that supports HTML5, for instance Internet Explorer version 9 or higher, Firefox version 17 or higher, or Google Chrome version 23 or higher.

### Instructions: Starting FRITZ!NAS in the Home Network

1. Open a web browser.
2. Enter "fritz.nas" in the address bar.
3. If password protection is configured: Log in to your FRITZ!Box.  
FRITZ!NAS opens and displays the storage media enabled in the FRITZ!Box.

### Instructions: Starting FRITZ!NAS in the Internet

1. Open a web browser.
2. Enter "myfritz.net" in the address bar of the browser.
3. Log in with email address and MyFRITZ! password.
4. Click "FRITZ!NAS" in the user interface.  
FRITZ!NAS opens and displays the storage media enabled in the FRITZ!Box.

## Expanding FRITZ!NAS Storage

### Overview

The FRITZ!Box storage is composed of:

- internal memory
- online storage
- USB storage media

Online storage can be configured with a provider. USB storage media can be connected to the FRITZ!Box. By combining these storage options, you can deploy the FRITZ!Box as high-performance network-attached storage.

### Access Rights

Access to FRITZ!NAS and thus to the storage media of the FRITZ!Box can be protected by defining a password in the user interface. For user-oriented rights management, you can configure different FRITZ!Box users. You can set a password for each FRITZ!Box user and specify which FRITZ!NAS contents they are allowed to access.

### Instructions: Configuring Online Storage

1. Open the user interface, [see page 51](#).
2. Select "Home Network / Storage (NAS)".
3. For instructions, open the online help .

### Instructions: Configuring USB Storage Media

1. Open the user interface, [see page 51](#).
2. Select "Home Network / USB Devices / Device Overview".
3. For instructions, open the online help .

---

## Displaying FRITZ!NAS in a File Manager

### Overview

You can display the network-attached storage of your FRITZ!Box in the file manager of your computer. This section explains how. You can display the network-attached storage of your in the file manager of your computer. This section explains how.

### Requirements

- Your computer is connected with the FRITZ!Box via network cable.

### Instructions: Displaying FRITZ!NAS in Windows Explorer

1. Open Windows Explorer.
2. Enter `fritz.nas` in the address bar.

The NAS of your FRITZ!Box is displayed in Windows Explorer. You can list, rename, copy and delete files. The NAS of your is displayed in Windows Explorer. You can list, rename, copy and delete files.

### Instructions: Displaying FRITZ!NAS in OS X Finder

1. Click the Finder icon with the right mouse button to open the context menu of the Finder.
2. Select the "Connect to Server..." option.
3. Enter the server address: `smb://fritz.nas`

The network-attached storage of your FRITZ!Box is displayed in the Finder. You can list, rename, copy and delete files. The network-attached storage of your is displayed in the Finder. You can list, rename, copy and delete files.



---

## Saving FRITZ!NAS Storage

### Overview

You can save the data you have stored on the internal FRITZ!NAS storage to a file.

### Instructions: Saving data from internal memory

1. Open FRITZ!NAS.
2. Select the data you would like to save.
3. Click in the FRITZ!NAS toolbar the icon for downloading, select a storage location for the data, and save with "OK".

The selected data are copied to a ZIP file in the download folder you specified. This concludes the saving of your data from the internal memory of the FRITZ!Box.

# MyFRITZ!

What Is MyFRITZ!?	211
Creating a MyFRITZ! Account	214
Configuring MyFRITZ!App: with Android	215
Configuring MyFRITZ!App: with iOS	216

## What Is MyFRITZ!?

### Overview

MyFRITZ! provides several additional functions for your FRITZ!Box, with which you can access various information and features of your FRITZ!Box via the internet, from on the go with your mobile device, or from the home network.

### MyFRITZ! Components

MyFRITZ! includes the following components:

	MyFRITZ! account / myfritz.net	MyFRITZ!App	MyFRITZ! / myfritz.box
Function	MyFRITZ! in the internet	MyFRITZ! mobile	MyFRITZ! in the home network
Access	a personal FRITZ!Box overview portal and, depending on the user rights, to FRITZ!Box functions	FRITZ!Box functions from on the go	FRITZ!Box functions in the home network
Log in	log in with MyFRITZ! account on the "myfritz.net" website	via a mobile device (with MyFRITZ!App installed)	via "MyFRITZ!" link in the FRITZ!Box user interface or via the "myfritz.box" address in the browser

### Using MyFRITZ! in the Internet: MyFRITZ! Account / myfritz.net

With the MyFRITZ! account you can log in to the FRITZ!Box overview page "myfritz.net" website and access your FRITZ!Box from there, for

instance, to retrieve information on calls, to access photo or music files, or to receive reports on the status of your FRITZ!Box devices.

Create a MyFRITZ! account with an email address and a password.

## FRITZ!Box Web Address

The MyFRITZ! account assigns the FRITZ!Box a web address accessible to the public.

If internet access to the FRITZ!Box is enabled and a FRITZ!Box user has been configured with the option “Access from the internet allowed”, then you can access your FRITZ!Box directly with a web browser, for instance via “myfritz.net”. You can also use the address to establish VPN connections to your FRITZ!Box or server services and network devices in the home network for which you configured port sharing in the FRITZ!Box; see [Configuring Port Sharing, page 96](#).

In the following cases, the assigned address cannot be reached from the internet:

- Your internet service provider did not assign a public IPv4 address to your FRITZ!Box, for instance for connections with the dual-stack lite protocol. The FRITZ!Box does not have a public IPv4 address if the message “FRITZ!Box uses a DS Lite tunnel” is displayed in the “Connections” section of the “Overview” menu in the user interface.

## Using MyFRITZ! from a Mobile Device: MyFRITZ!App

With the free MyFRITZ!App you can access your FRITZ!Box from anywhere using your mobile device:

- Messages: view the FRITZ!Box call list and listen to messages on the answering machine
- Home network: access the FRITZ!Box user interface and connected home network devices securely
- Smart Home: control smart plugs and radiator controls

- FRITZ!NAS: access connected USB storage media, for instance for photos, music and videos
- Convenience functions: control answering machines and call diversion settings



To use the MyFRITZ!App with iOS, a MyFRITZ! account and a FRITZ!Box user account must be configured; [see page 183](#).

### Using MyFRITZ! in the Home Network: [myfritz.box](http://myfritz.box)

Via the “MyFRITZ!” overview page at the address “myfritzbox” address you can access functions of your FRITZ!Box frequently used in the home network from your browser:

- Call list: view calls and listen to messages
- NAS: access photos, music, videos
- Convenience functions: display and switch WiFi, WPS, guest access, answering machines on and off
- Smart Home: switch and control smart plugs and radiator controls

Which functions you can access depends on the rights configured for the FRITZ!Box users logged in. If you logged in with the general FRITZ!Box password, you have access to all areas; [see Configuring FRITZ!Box Users and FRITZ!Box Password, page 183](#).

## Creating a MyFRITZ! Account

### Overview

In order to be able to use MyFRITZ! via the “myfritz.net” website or via the MyFRITZ!App for iOS, a MyFRITZ! account is needed. When the MyFRITZ! account is created, the FRITZ!Box from which the account is created is registered with the MyFRITZ! account.

If you would like to use MyFRITZ! only via the MyFRITZ!App for Android (version 2), then you do not need a MyFRITZ! account.

### MyFRITZ! Account and FRITZ!Box

You only have to set up a MyFRITZ! account once. It exists no matter which FRITZ!Box was used to create it. Once an account has been created you can register any number of FRITZ!Box models with your MyFRITZ! account. If you switch to a new FRITZ!Box, you can then register the new model with your existing MyFRITZ! account and delete any old FRITZ!Box models no longer in use.

### Requirements

- The browser on your device is connected with the internet.
- You can access your email on the device used.

### Instructions: Creating a New MyFRITZ! Account or Using an Existing MyFRITZ! Account

1. Open the user interface, [see page 51](#).
2. Select “Internet / MyFRITZ! Account”.
3. For instructions, open the online help .

## Configuring MyFRITZ!App: with Android

### Overview

With the MyFRITZ!App (version 2) you can access your FRITZ!Box from anywhere using your Android device.

The MyFRITZ!App 2 from AVM can be downloaded free from the [Google Play Store](#).

### Requirements

- Android smartphone or Android tablet with Google Android 4 (or newer)
- Your Android mobile device is located in the wireless network of your FRITZ!Box.
- For registration with FRITZ!Box users: The user has "FRITZ!Box Settings rights."
- For the connection to the home network: The "Allow access for applications" option is enabled in the "Access Settings in the Home Network" section of the "Home Network / Network / Network Settings".

### Instructions: Configuring MyFRITZ!App

1. Install the MyFRITZ!App 2 from the Google Play Store on your mobile device.
2. Open the MyFRITZ!App.
3. If multiple FRITZ!Box models are displayed, select the FRITZ!Box you want to connect with.
4. To register with the FRITZ!Box, enter the required data.  
The MyFRITZ!App connects with the FRITZ!Box.
5. To configure secure access to the FRITZ!Box user interface and the connected home network devices, then tap on "Home Network" and follow the instructions for configuring the home network connection.

## Configuring MyFRITZ!App: with iOS

### Overview

With the MyFRITZ!App you can access your FRITZ!Box from anywhere using your Apple mobile device.

The MyFRITZ!App from AVM is available for free download in the [Apple App Store](#).

### Requirements

- iPhone (model 4GS or later) or iPod touch (5th generation or higher) or iPad with iOS 9.0 (or later).
- Your Apple mobile device is located in the wireless network of your FRITZ!Box.
- You configured a MyFRITZ! account and your FRITZ!Box is registered with this MyFRITZ! account.
- An account as a FRITZ!Box user has been set up for you in your FRITZ!Box, and the FRITZ!Box user has the rights "Access from the internet allowed" and "FRITZ!BoxSettings".

### Instructions: Configuring MyFRITZ!App

1. Install the MyFRITZ!App on your mobile Apple device.
2. Open the MyFRITZ!App.
3. If multiple FRITZ!Box models are displayed, select the FRITZ!Box you want to connect with.
4. To register with the FRITZ!Box, enter the required data.  
The MyFRITZ!App connects with the FRITZ!Box.



# Controlling FRITZ!Box with Keypad Codes

Information on Keypad Codes.....	218
Configuration on the Telephone.....	220
Operation at the Telephone.....	233
Restoring Factory Settings with the Telephone .....	245



## Information on Keypad Codes

### Overview

Various FRITZ!Box functions can be configured and operated using a connected telephone without opening the user interface. These include not only telephony functions like the alarm, Do Not Disturb and call diversion, but also other functions. For instance, you can switch wireless LAN on and off, and restore the factory settings to the FRITZ!Box.

### How It Works

Keypad codes are combinations of keys (for instance, **#811\*1\***), which you enter on the telephone keypad.

### Requirements

- Use a connected analog telephone, ISDN telephone or DECT telephone to enter keypad codes. (Keypad codes do not work with smartphones or IP telephones.)
- For analog telephones, ISDN telephones and DECT telephones with their own base station: The telephone is configured such that special characters (**\*** and **#**) can be dialed; see the manual of your telephone.

### Entering Keypad Codes

A keypad code can contain the following characters: **\***, **#**, the numerals **0** to **9**. Depending on the type of telephone, here is how to dial keypad codes:





Type of Telephone	Dial Keypad Code
Telephone without call button	<ul style="list-style-type: none"> <li>• Pick up the handset.</li> <li>• Enter the keypad code.</li> <li>• Hang up.</li> </ul>

Type of Telephone	Dial Keypad Code
Telephone with call button (usually green)	<ul style="list-style-type: none"><li>• Enter the keypad code.</li><li>• Press the “Call” (“Connect”) button.</li><li>• Press the end call key.</li></ul>





## Configuration on the Telephone

### Instructions: Disabling Automatic Outside Dialing for the FON 1 or FON 2 Port

If you make a lot of internal calls, you can disable automatic outside dialing on the “FON 1” and “FON 2” ports. Then you can enter internal numbers without the prefix \*\* (for instance, 1 instead of \*\*1). Instead, you must dial the prefix 0 for outside calls (for instance, 0030399760 instead of 030399760).





Telephone without Call Button	Telephone with Call Button
	
Disable automatic outside dialing: <b># 1 1 * 0 *</b> (FON 1) <b># 1 2 * 0 *</b> (FON 2)	
	
Wait for acknowledgment tone	
	

Instructions: Enabling Automatic Outside Dialing for the FON 1 or FON 2 Port





Telephone without Call Button	Telephone with Call Button
	
<p>Enable automatic outside dialing:</p> <p># 1 1 * 1 * (FON 1)</p> <p># 1 2 * 1 * (FON 2)</p>	
	
<p>Wait for acknowledgment tone</p>	
	

## Instructions: Switching On Call Diversion for All Calls

Call diversion automatically diverts incoming calls to a previously specified external telephone number. If your telephone provider supports this, calls will be diverted by your provider and your line will remain free for other calls. Otherwise the FRITZ!Box establishes a second connection. In either case, extra charges will accrue according to your contracted telephone rates. In either case, extra charges will accrue according to your contracted telephone rates.





Telephone without Call Button	Telephone with Call Button
	
<p>Configure immediate call diversion to destination call number &lt;DCN&gt;:  <b>*21* &lt;DCN&gt;*#</b></p> <p>Configure call diversion after 20 seconds to destination call number &lt;DCN&gt;:  <b>*61* &lt;DCN&gt;*#</b></p> <p>Configure call diversion on busy to the destination call number &lt;DCN&gt;:  <b>*67* &lt;DCN&gt;*#</b></p>	
	
<p>Wait for acknowledgment tone</p>	
	

## Instructions: Switching Off Call Diversion for All Calls

Telephone without Call Button	Telephone with Call Button
	
<p>Switch off immediate call diversion:  <b>*21**#</b></p> <p>Switch off delayed call diversion:  <b>*61**#</b></p> <p>Switch off call diversion on busy:  <b>*67**#</b></p>	
	
<p>Wait for acknowledgment tone</p>	
	





## Instructions: Switching On Call Diversion for One Telephone Number

If you have multiple telephone numbers, you can configure call diversion that is applied to only one specified telephone number (TN). Calls for your other telephone numbers will not be diverted.





Telephone without Call Button	Telephone with Call Button
	
<p>Switch on immediate call diversion to destination call number &lt;DCN&gt;:</p> <p><b>*21* &lt;DCN&gt;* &lt;TN&gt;#</b></p> <p>Switch on call diversion after 20 seconds to destination call number &lt;DCN&gt;:</p> <p><b>*61* &lt;DCN&gt;* &lt;TN&gt;#</b></p> <p>Switch on call diversion on busy to the destination call number &lt;DCN&gt;:</p> <p><b>*67* &lt;DCN&gt;* &lt;TN&gt;#</b></p>	
	
<p>Wait for acknowledgment tone</p>	
	







## Instructions: Switching Off Call Diversion for One Telephone Number

Telephone without Call Button	Telephone with Call Button
	
<p>Switch off immediate call diversion:  <b>*21**&lt;TN&gt;#</b></p> <p>Switch off delayed call diversion:  <b>*61**&lt;TN&gt;#</b></p> <p>Switch off call diversion on busy:  <b>*67**&lt;TN&gt;#</b></p>	
	
<p>Wait for acknowledgment tone</p>	
	





## Instructions: Switching On Call Diversion for the FON 1 Port

Telephone without Call Button	Telephone with Call Button
	
<p>Switch on immediate call diversion for the FON 1 port without ringing to destination call number &lt;DCN&gt;:</p>	
<p><b>#411* &lt;DCN&gt;*</b></p>	
<p>Switch on immediate call diversion for the FON 1 port with ringing to destination call number &lt;DCN&gt;:</p>	
<p><b>#451* &lt;DCN&gt;*</b></p>	
<p>Switch on call diversion for the FON 1 port after 20 seconds to destination call number &lt;DCN&gt;:</p>	
<p><b>#421* &lt;DCN&gt;*</b></p>	
<p>Switch on call diversion for the FON 1 port on busy to the destination call number &lt;DCN&gt;:</p>	
<p><b>#431* &lt;DCN&gt;*</b></p>	
<p>Switch on immediate call diversion for the FON 1 port on busy, otherwise delayed, to the destination call number &lt;DCN&gt;:</p>	
<p><b>#441* &lt;DCN&gt;*</b></p>	
	
<p>Wait for acknowledgment tone</p>	
	





## Instructions: Switching Off Call Diversion for the FON 1 Port

Telephone without Call Button	Telephone with Call Button
	
<p>Switch off call diversion for the FON 1 port: #401**</p>	
	
<p>Wait for acknowledgment tone</p>	
	

## Instructions: Switching On Call Diversion for the FON 2 Port

Telephone without Call Button	Telephone with Call Button
	
<p>Switch on immediate call diversion for the FON 2 port without ringing to destination call number &lt;DCN&gt;:</p>	
<p><b>#412* &lt;DCN&gt; *</b></p>	
<p>Switch on immediate call diversion for the FON 2 port with ringing to destination call number &lt;DCN&gt;:</p>	
<p><b>#452* &lt;DCN&gt; *</b></p>	
<p>Switch on call diversion for the FON 2 port after 20 seconds to destination call number &lt;DCN&gt;:</p>	
<p><b>#422* &lt;DCN&gt; *</b></p>	
<p>Switch on call diversion for the FON 2 port on busy to the destination call number &lt;DCN&gt;:</p>	
<p><b>#432* &lt;DCN&gt; *</b></p>	
<p>Switch on immediate call diversion for the FON 2 port on busy, otherwise delayed, to the destination call number &lt;DCN&gt;:</p>	
<p><b>#442* &lt;DCN&gt; *</b></p>	
	
<p>Wait for acknowledgment tone</p>	
	

## Instructions: Switching Off Call Diversion for the FON 2 Port



Telephone without Call Button	Telephone with Call Button
	
<p>Switch off call diversion for the FON 2 port: <b>#402**</b></p>	
	
<p>Wait for acknowledgment tone</p>	
	

## Instructions: Configuring a Telephone as a Baby Monitor

You can configure a telephone on the “FON 1” or “FON 2” port as a baby monitor and use it to listen in on a room. As soon as a certain noise level is reached, the telephone then automatically calls a previously specified telephone number, for instance, of your mobile telephone.







You can also use your FRITZ!Fon cordless telephone as a baby monitor. See the manual of your FRITZ!Fon for instructions.





Telephone without Call Button	Telephone with Call Button
	
<p>Press the following keys:</p> <p><b># 4 &lt;level&gt; * &lt;TN&gt; #</b></p> <p>&lt;Level&gt; specifies the sensitivity. Permitted values: 1 (highest) – 8 (lowest)</p> <p>&lt;TN&gt; is the internal or external telephone number that the baby monitor is supposed to call. Internal numbers should also be entered without **.</p>	
	
<p>The baby monitor is enabled. Hang up to disable it.</p>	

## Instructions: Switching Wireless LAN On

The wireless radio network of your FRITZ!Box can be switched on and off using a connected telephone.

Telephone without Call Button	Telephone with Call Button
	
Switch wireless LAN on: <b>#96*1*</b>	
	
Wait for acknowledgment tone	
	

## Instructions: Switching Wireless LAN Off

Telephone without Call Button	Telephone with Call Button
	
Switch wireless LAN off: <b>#96*0*</b>	
	
Wait for acknowledgment tone	
	





## Operation at the Telephone

### Instructions: Operating the Answering Machine with the Telephone

You can operate the answering machine with the telephone using a voice menu, for instance to switch the answering machine on or off and to listen to messages.

Here is how to establish a connection to the answering machine:

Telephone without Call Button	Telephone with Call Button
	
<p>Establish a connection to the answering machine:</p> <ul style="list-style-type: none"> <li><b>* * 6 0 0</b> (answering machine 1)</li> <li><b>* * 6 0 1</b> (answering machine 2)</li> <li><b>* * 6 0 2</b> (answering machine 3)</li> <li><b>* * 6 0 3</b> (answering machine 4)</li> <li><b>* * 6 0 4</b> (answering machine 5)</li> </ul>	
	
<p>Follow the voice menu</p>	



## Voice Menu of the Answering Machine

Main Menu (Level 1)	Level 2	Level 3
<b>1</b> Play back messages	<b>3</b> Return call <b>5</b> Delete message <b>7</b> To previous message <b>9</b> To next message	
<b>2</b> Delete all messages		
<b>3</b> Answering machine on/off		
<b>4</b> Record a greeting	<b>1</b> Greeting message <b>2</b> Greeting for announcement mode <b>3</b> Closing message	<b>1</b> Listen to all greetings, select greeting with <b>2</b> <b>5</b> Delete greeting/announcement <b>8</b> Record greeting, end with <b>1</b>
<b>5</b> Enable recording/announcement mode (no messages recorded in announcement mode)		

## Instructions: Picking Up a Call from the Answering Machine or Telephone



You can pick up and take the following calls on connected telephones:

- Calls that have already been accepted by an answering machine. This can be the FRITZ!Box answering machine or a connected answering machine.
- Calls that arrive at another connected telephone (the other telephone rings).

Telephone without Call Button	Telephone with Call Button
	
<p>Press the following keys:</p> <p><b>* 0 9</b></p>	
	



## Instructions: Making Internal Calls

You can conduct free internal calls between connected telephones.

Telephone without Call Button	Telephone with Call Button
	
<p>Enter the internal telephone number (see the telephone book in the user interface)</p>	
	



## Instructions: Starting a Broadcast Call

A group call or broadcast call is an internal call that is signaled on all telephones connected with the FRITZ!Box.

Telephone without Call Button	Telephone with Call Button
	
<p>Press the following keys for a broadcast call:</p> <p><b>* * 9</b></p>	
	
<p>All telephones on the FRITZ!Box ring. You will be connected to the telephone that picks up the call first.</p>	

## Instructions: Transferring Calls

With the “Call Transfer” feature you can forward a call to another connected telephone or to an external telephone number.



Telephone without Call Button	Telephone with Call Button
<p>During the call with the party 1, press the hold button:</p>	
<p><b>R</b></p>	
<p>The call is on hold.</p>	
<p>Enter the telephone number of party 2. This can be an external telephone number or an internal number (see the telephone book in the user interface).</p>	
<p>When party 2 accepts the call, connect party 1 and party 2 with each other:</p>	
	<p>On cordless telephones:</p> <p><b>* 4</b></p> <p>Others:</p> 
<p>If party 2 cannot be reached, go back to party 1:</p> <p><b>R 1</b></p>	

## Instructions: Picking Up from Call Waiting

When the call waiting feature is enabled for a telephone, you are notified about incoming calls during an active telephone call. You hear a signal tone. You can accept or reject waiting calls.

Telephone without Call Button	Telephone with Call Button
During a call:	
Pick up from call waiting: <b>R 2</b>	
Reject waiting call: <b>R 0</b>	
If you pick up the waiting call, you can:	
Switch between call 1 and call 2 (alternate): <b>R 2</b>	
End the active call and continue the other call: Hang up, wait until your telephone rings and pick up	

## Instructions: Suppressing a Telephone Number Once

Telephone without Call Button	Telephone with Call Button
	
<p>Press the following keys:</p> <p><b>*31#</b></p>	
<p>Enter the external telephone number</p>	
	

## Instructions: Setting up a Three-Party Conference Call

A three-party conference call is a call with three participants. The call can be conducted with external or internal parties.

Telephone without Call Button	Telephone with Call Button
During the call with the party 1, press the hold button: <b>R</b>	
Call 1 is on hold.	
To establish the call with party 2, enter an internal or external telephone number.	
When party 2 accepts the call, establish the three-party conference: <b>R 3</b>	
If party 2 cannot be reached, go back to party 1: <b>R</b>	
During the three-party conference call you can:	
Interrupt the conference (you speak with party 1, call 2 is on hold): <b>R 2</b>	
Switch back and forth between parties 1 and 2 (alternate): <b>R 2</b>	
Restore an interrupted conference: <b>R 3</b>	
End call 2 and continue with call 1: <b>R 1</b>	
End the active call and continue the other call: Hang up, wait until your telephone rings and pick up	





## Instructions: Holding/Consultation/Alternating

During a telephone call you can establish a connection to another party (consultation) without ending the first call (the call is on hold). You can alternate between the two parties as often as you like.

Telephone without Call Button	Telephone with Call Button
During the call with the party 1, press the hold button:	
<p><b>R</b></p>	
The call is on hold.	
To establish the call with party 2, enter an internal or external telephone number.	
When party 2 accepts the call, you can:	
Alternate back and forth between the calls: <b>R 2</b>	
End the active call and continue the other call: Hang up, wait until your telephone rings and pick up	
If party 2 cannot be reached, go back to party 1: <b>R</b>	





## Instructions: Using Keypad Shortcuts

Keypad shortcuts are commands consisting of characters and numerals which you enter on the telephone. With keypad shortcuts you can control services and features in your telephone provider's network. For information about which keypad shortcuts you can use, contact your telephone provider.





Telephone without Call Button	Telephone with Call Button
	
<p>Press the following keys (&lt;Seq&gt; is the keypad shortcut):</p> <p><b>*#&lt;Seq&gt;</b></p>	
	

## Instructions: Enabling an Alarm

You can use connected telephones for alarm calls. For this you can set up, enable and disable up to three alarms under "Telephony / Alarm" in the user interface. The first alarm configured can also be enabled and disabled with the telephone keys.

Telephone without Call Button	Telephone with Call Button
	
Switch on the alarm: <b>#881**</b>	
	
Wait for acknowledgment tone	
	

## Instructions: Disabling an Alarm

Telephone without Call Button	Telephone with Call Button
	
Switch alarm off: <b># 8 8 1 #</b>	
	
Wait for acknowledgment tone	
	

## Restoring Factory Settings with the Telephone





### Overview

You can restore factory settings to the FRITZ!Box by telephone. This is necessary, for instance, if you can no longer access the user interface of your FRITZ!Box because you've forgotten your password and did not configure the "Forgot password" push service. Then the FRITZ!Box is reset to its factory settings.

### Consequences of Resetting

- All of the settings you made in the FRITZ!Box will be deleted.
- The internal memory of the FRITZ!Box is deleted. Contents on FRITZ!NAS, messages on the answering machine and received faxes will be discarded.
- The preconfigured FRITZ!Box password is restored.
- The preconfigured network key and the preconfigured name of the wireless radio network (SSID) are reactivated.
- The preconfigured IP configuration is restored.

## Instructions: Loading Factory Settings

Telephone without Call Button	Telephone with Call Button
	
<p>Restore factory settings to FRITZ!Box: <b>#991*15901590*</b></p>	
	
<p>Wait for acknowledgment tone</p>	
	

# Malfunctions

Troubleshooting Procedures .....	248
Troubleshooting Chart.....	249
Opening the User Interface with the Emergency IP Address .....	252
Knowledge Base .....	254
Support .....	255

## Troubleshooting Procedures

### Overview

The following table offers recommendations about what do when problems with your FRITZ!Box arise:

Error Scenario	Remedy
No access to the user interface	Troubleshooting chart; <a href="#">see page 249</a>
Comprehensive help for problems with: <ul style="list-style-type: none"><li>• connections</li><li>• configuration</li><li>• Telephony</li><li>• Internet</li><li>• Wireless</li><li>• etc.</li></ul>	Knowledge Base; <a href="#">see page 254</a>
Troubleshooting chart and Knowledge Base do not offer a solution.	Support; <a href="#">see page 255</a>



## Troubleshooting Chart

### Overview

If malfunctions occur, for instance, such that you can no longer access the user interface of the FRITZ!Box, first try to solve the problems using the following tables.

### Troubleshooting Chart

Error Scenario	Cause	Solution
LEDs not on	Power supply interrupted	<ul style="list-style-type: none"> <li>• Make sure the power supply unit is connected properly.</li> <li>• Try plugging in a different device to make sure that the electrical outlet is active.</li> </ul>
Cannot establish a wireless LAN connection	Computer's wireless LAN adapter not ready for operation	Switch on your computer's wireless LAN adapter. For details, consult the manual of your computer.
	Wireless radio network of the FRITZ!Box switched off	When the "WLAN" LED is off, press the WLAN button on the FRITZ!Box. Hold it down until the "WLAN" LED begins flashing.
	Computer cannot find the wireless network of the FRITZ!Box	Enable the "Name of the wireless radio network visible" function ("Wireless / Radio Network") in the FRITZ!Box user interface.
	Incorrect network key	Enter the correct network key ("Wireless / Security").

Error Scenario	Cause	Solution
The user interface does not open	Path name incorrect	Open the user interface by entering its complete address ( <a href="http://fritz.box">http://fritz.box</a> instead of fritz.box).
	FRITZ!Box has crashed	Remove the FRITZ!Box from the power mains and restart the FRITZ!Box again after about five seconds.
	Cache is full	Empty the cache of your web browser.  For more information on this, see the help of your web browser.
	Proxy configuration does not allow the FRITZ!Box address	If a proxy server is enabled in your web browser, the address of the FRITZ!Box must be entered as an exception. Check your web browser settings.  For more information on this, see the help of your web browser.
	Computer is not configured to obtain IP address automatically	On your computer, enable the setting "Obtain an IP address automatically" for the network adapter used to connect to the FRITZ!Box.  For more information, see the documentation by the manufacturer of your operating system.

Error Scenario	Cause	Solution
The user interface does not open	Forgot FRITZ!Box password	Restore factory settings to the FRITZ!Box (see page 196).
	Combination of various settings in the "Internet" and "Home Network" menus.	Attempt to open the user interface with the emergency IP address; see page 252. If this does not work, restore factory settings to the FRITZ!Box (see page 196).
Wireless LAN connection interrupted	Wireless radio connection between FRITZ!Box and wireless device interrupted	Change the positions of the FRITZ!Box and the wireless devices: <ul style="list-style-type: none"> <li>Do not place the FRITZ!Box in the corner of a room.</li> <li>Do not place the FRITZ!Box directly next to or beneath an obstacle or a metal object (like a cabinet or radiator).</li> <li>Position the FRITZ!Box and the wireless devices so that there are as few obstacles between them as possible.</li> </ul>
	Radio channel with heavy interference	Configure automatic selection of the radio channel in the FRITZ!Box user interface.  Then the FRITZ!Box will automatically select a radio channel with as little interference as possible ("Wireless / Radio Channel").

## Opening the User Interface with the Emergency IP Address

### Overview

The FRITZ!Box has an emergency IP address at which it can always be reached. The emergency IP address can be useful if you can no longer access the FRITZ!Box user interface, for instance due to erroneous configurations.

### Information on the Emergency IP Address

- The emergency IP address is: 169.254.1.1
- The emergency IP address cannot be changed.

### Requirements

- The computer from which you want to open the user interface with the emergency IP address must be connected by network cable to a LAN port of the FRITZ!Box.
- This computer is not connected with the FRITZ!Box via LAN guest access.

### Instructions: Opening the User Interface with the Emergency IP Address

1. Clear all other connections between your FRITZ!Box and other network devices.
2. If your computer is connected with the FRITZ!Box over wireless LAN, clear the wireless connection.
3. Connect your computer to the "LAN 2" port of the FRITZ!Box using a LAN cable.
4. Restart your computer.
5. Enter the emergency IP address in the web browser on the computer: 169.254.1.1

6. If the user interface is protected with a password: Enter your password.
7. If the FRITZ!Box user interface is not displayed, you have to assign the IP address 169.254.1.2 to the network adapter connected with the FRITZ!Box. Instructions from the AVM Knowledge Base can be viewed by searching in Google for Configuring a network adapter to access the user interface with emergency IP address.

## Knowledge Base

### Overview

Help for resolving problems with the FRITZ!Box is provided in the AVM Knowledge Base. This resource presents answers to the questions asked most frequently of our Support team.

If the problem cannot be resolved using the Knowledge Base, then contact the Support team; [see page 255](#).

### AVM Knowledge Base

The AVM Knowledge Base is available online at:  
[en.avm.de/service](http://en.avm.de/service)

## Support

### Overview

The Support team assists you in resolving any problems with your FRITZ! products.

### Preparation

Keep the following device information handy:

- Model
- Serial number
- FRITZ!OS version
- Country
- Internet service provider
- Information on the operating system, network (LAN or wireless LAN), any error messages displayed

### Instructions: Support by email

1. Start a web browser on your computer, tablet or smartphone.
  2. Enter the following address: <https://en.avm.de/service>.
  3. Select from the "Service" area the FRITZ!Box model for which you need support.
  4. Enter a keyword in the search field of the Knowledge Base or select an FAQ (frequently asked question).
  5. If you need more help, click "Support request".
  6. Fill out the form and click "Submit support request".
- Our Support team will respond by email within one working day.

# Decommissioning and Disposal

Decommissioning.....	257
Disposal .....	258





## Decommissioning

### Restoring Factory Settings

Before you decommission your FRITZ!Box and perhaps dispose of it, you should restore the factory settings to the FRITZ!Box. This ensures that all of your personal settings and data are deleted. Read the instructions on how to do this at [see Restoring Factory Settings, page 196](#).

## Disposal

### Disposal of Used Devices

In accordance with European regulations, the FRITZ!Box, as well as all devices and electronic components contained in the package, may not be disposed with household waste.

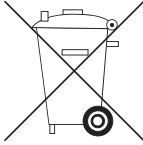

Comply with the symbol for the separate collection of electric and electronic devices on the type label of your FRITZ!Box (bottom of the housing).



After use, please dispose of FRITZ!Box and all electronic components and devices included with delivery at a collection point in your local community for the disposal of electric and electronic appliances.

# Appendix

Technical Specifications ..... 260  
Legal ..... 264  
Information on Cleaning ..... 268



## Technical Specifications

### Device Properties

Property	Value
Dimensions (W x H x D)	circa 85 x 209 x 273 mm
Supply voltage	230 V / 50 Hz

### Ambient Conditions

Property	Value
Operating temperature	0 °C – +40 °C
Storage temperature	-20 °C – +70 °C
Relative humidity (operation)	10 % – 90 %
Relative humidity (storage)	5 % – 95 %

### Active Power

Property	Value
Maximum active power	27.5 W
Intermediate active power, determined with the following load: <ul style="list-style-type: none"> <li>• Cable connection enabled</li> <li>• Wireless LAN on; no devices registered via wireless LAN</li> <li>• DECT on; one telephone registered via DECT; no active calls</li> <li>• One network device connected to a LAN port; no data transfer; other LAN ports not in use</li> </ul>	11 W

## Network Access Interfaces

Interface specification for public networks:

- IETF RFC 3261 (Session Initiation Protocol for Voice over IP)
- ETSI TS 103 311 (DOCSIS 3.1 cable broadband access for internet and telephony)
- Broadband Forum TR-069 (CPE WAN Management Protocol)

## Ports and Interfaces

Connect via	Interface
Cable	Cable modem compliant with DOCSIS 3.1, downward compatible with EuroDOCSIS 3.0. EuroDOCSIS 3.1 channels: 2 in the receive direction and 2 in the send direction. DOCSIS 3.0 channels: Up to 32 in the receive direction and up to 8 in the send direction
FON	<ul style="list-style-type: none"> <li>• 1 a/b port with a RJ11 and TAE socket for connecting an analog terminal device</li> <li>• 1 a/b port with a RJ11 socket for connecting an analog terminal device (terminal devices with a TAE plug can be connected using the TAE/RJ11 adapter included with delivery)</li> </ul>
FON S <sub>0</sub>	1 ISDN S <sub>0</sub> NT port with support for ISDN terminal devices; the CIP services voice, telephony, audio 3.1 and fax G2/G3 are supported
DECT	DECT base station: <ul style="list-style-type: none"> <li>• up to 6 handsets</li> <li>• up to 10 FRITZ!DECT 200/210 outlet switches</li> <li>• up to 12 FRITZ!DECT 300/301/Comet DECT radiator controls</li> </ul>

Connect via	Interface
LAN	4 LAN ports via RJ45 sockets (standard Ethernet, 10/100/1000 Base-T)
USB	2 USB host controllers (USB version 3.0)
Wireless	<p>Wireless access point with support for wireless LAN radio networks (wireless standard – data rate)</p> <ul style="list-style-type: none"> <li>• IEEE 802.11a – 54 Mbit/s</li> <li>• IEEE 802.11b – 11 Mbit/s</li> <li>• IEEE 802.11g – 54 Mbit/s</li> <li>• IEEE 802.11n – 800 Mbit/s (including 256QAM)</li> <li>• IEEE 802.11ac – 1733 Mbit/s</li> </ul>

### Wireless LAN Radio Frequencies

Frequency	Frequency Ranges	Maximum Transmitter Power
2.4 GHz	2400 MHz – 2483 MHz	100 mW
5 GHz	5150 MHz – 5350 MHz	200 mW
	5470 MHz – 5725 MHz	1000 mW

In the 5-GHz band for wireless LAN, the range from 5150 MHz to 5350 MHz is intended only for indoor use. This restriction or requirement is effective in the EU member states AT, BE, BG, CY, CZ, DE, DK, EE, EL, ES, FI, FR, HR, HU, IE, IT, LT, LU, LV, MT, NL, PL, PT, RO, SE, SI, SK, UK.

### DECT Radio Frequencies

Frequency	Frequency Range and Transmitter Power
DECT	<ul style="list-style-type: none"> <li>• Frequency range: 1880 MHz – 1900 MHz</li> <li>• Maximum transmitter power: 250 mW</li> </ul>

## Electromagnetic Fields

The FRITZ!Box receives and transmits radio waves during operation.

- The FRITZ!Box was designed and constructed to comply with the threshold values for the exposition of radio waves recommended by the International Commission on Non-ionizing Radiation Protection (ICNIRP).
- This directive was formulated by independent scientific organizations after regular and careful evaluation of scientific studies. It includes a large safety margin in order to ensure the safety of all persons, regardless of their age and health.
- For devices mounted in a fixed position that have their own power connection, like the FRITZ!Box, compliance with the minimum distance of 20 cm defined in the ICNIRP guideline has been certified. The measurements were conducted in accordance with the European EN 50385 standard.

## Audio Tones

Beep	Melody
Busy signal	500 ms tone, 500 ms pause, +/- 20 ms
Dial tone	1 s tone, 4 s pause, +/- 100 ms

---

## Legal

### Manufacturer's Warranty

We offer a manufacturer's warranty of 5 years on the hardware of this original product. The warranty period begins with the purchase date from the first end user. Compliance with the warranty period can be proven by submission of the original invoice or comparable documents. This warranty does not restrict your warranty rights based on the contract of sale or other statutory rights.

Within the warranty period, we will remove defects to the product which are demonstrably due to faults in materials or manufacturing. Our warranty does not cover defects which occur due to incorrect installation, improper use, non-observance of instructions in the user manual, normal wear and tear or defects in the environment of the system (third-party hardware or software). We may, at our discretion, repair or replace the defective product. Claims other than the right to the removal of defects which is mentioned in these terms of warranty are not constituted.

We guarantee that the software conforms with general specifications, not, however, that the software meets your individual requirements. Delivery costs will not be reimbursed. Products which have been replaced revert to our ownership. Claims recognized under warranty entail neither an extension or recommencement of the warranty period. If we reject a warranty claim, this claim lapses no later than six months after being rejected by us.

This warranty shall be governed by German substantive law, to the exclusion of the United Nations Convention on Contracts for the International Sale of Goods (CISG).

### Legal Notice

This documentation and the relevant programs (both herein referred to as "Software") are protected by copyright.





Please inform us about contents that are erroneous or no longer up to date at [info@avm.de](mailto:info@avm.de).

Software is delivered in machine-readable format only (object code format). Under all AVM intellectual property rights, AVM hereby grants licensee the non-exclusive right to use the Software. Unless agreed for a limited time period, the right to use the Software is for an unlimited time period. The licensee may create only one copy of the software, which may be used exclusively for backup use. Unless granted by mandatory law (including but not limited to Art. 69 German Copyright Act for decompiling), licensee shall not be entitled to modify, disassemble, reverse engineer, decompile or otherwise alter the Software in whole or in part. AVM reserves all intellectual property rights except as expressly granted herein. Licensee shall not be entitled to modify or delete alpha-numerical or other identification codes on data media and shall transfer such identification codes onto any legal backup copy. Without the prior written approval of AVM, licensee shall not be entitled to transmit any information made available herein.

If licensee has received the Software not for commercial purposes of resale (end user), licensee shall be obliged to transmit the right to use the Software to a third party only in connection with the product licensee acquired together with the Software. In the event that licensee transfers the right to use the Software to a third party, licensee shall ensure not to grant further rights to this third party than originally granted to AVM, and licensee shall ensure to impose this third party the obligations of the present license terms. In such case, licensee shall not withhold any backup copy. Licensee shall not be entitled to grant sublicenses. In the event licensee transmits the Software to a third party, licensee shall be responsible for and shall release AVM insofar from the compliance of export control laws and obligations.

If and insofar AVM provides Software for which AVM is only granted a derived right to use (Third Party Software), the license terms for such Third Party Software shall additionally apply and prevail. If and insofar certain Third Party Software in object code format by Texas Instru-

ment („TI Software“) is provided together with this Software, licensee may only distribute such TI Software pursuant to a written license agreement which restricts use to TI Software embedded in the AVM hardware product licensee acquired together with the Software and prohibits (unless granted by mandatory law) copying, reverse engineering, decompiling or disassembling of TI Software. If Open Source Software is provided, the license terms for such Open Source Software shall additionally apply and prevail. AVM shall provide licensee with the corresponding source code of relevant Open Source Software, if the respective license terms of the Open Source Software include such obligation. AVM shall inform if the Software contains Third Party Software and/or Open Source Software and make available the corresponding license terms on request.

The licensing conditions are presented in the help for the FRITZ!Box 6591 Cable user interface under the “Legal Notice” heading.

This documentation and the software have been produced with all due care and checked for correctness in accordance with the best available technology. AVM disclaims all liability and warranties, whether express or implied, relating to this software's quality, performance or suitability for any given purpose which deviates from the performance specifications contained in the software description. AVM shall not be liable for damages arising directly or indirectly from the use of the manual or related software, nor for incidental or consequential damages, except in case of intent or gross negligence. AVM explicitly disclaims all liability for loss of or damage to hardware, software or data in connection with direct or indirect errors or destruction, for cases of damage (including fraud cases) incurred due to deficient or incorrect configurations (including configurations that use insufficient or no password protection) over connections (including, but not limited to broadband connections like DSL, cable/DOCSIS and fiber optic, also including VoIP or SIP connections), and for any and all costs, including connection charges, related to the software supplied or due to incorrect installations not performed by AVM.

AVM accepts no obligations to perform software service. These require a separate agreement. The information in this Software is subject to change without notice for the purpose of technical improvement.

Marks: Marks like AVM, FRITZ! and FRITZ!Box (product names and logos) are protected marks owned by AVM GmbH. Microsoft, Windows and the Windows logo are trademarks owned by Microsoft Corporation in the USA and/or other countries. Apple, App Store, iPhone, iPod and iPad are marks owned by Apple Inc. in the USA and/or other countries. IOS is a mark owned by Cisco Technology Inc. in den USA and/or other countries. Google and Android are marks owned by Google Inc. in the USA and/or other countries. All other product and company names are trademarks of their respective owners.

## Copyright



© AVM 2018-2019. All rights reserved. © . All rights reserved.

AVM Audiovisuelles Marketing  
und Computersysteme GmbH

Alt-Moabit 95

D-10559 Berlin

AVM in the internet: [en.avm.de](http://en.avm.de)

AVM Computersysteme  
Vertriebs GmbH

Alt-Moabit 95

D-10559 Berlin

## Declaration of CE Conformity

AVM declares herewith that the device is compliant with the basic requirements and the relevant rules in directives 2014/53/EU, 2009/125/EC and 2011/65/EU.

The long version of the declaration of CE conformity is available at [en.avm.de/ce](http://en.avm.de/ce).

## Information on Cleaning

### Rules

Keep the following rules in mind for cleaning your FRITZ!Box:

- Remove the FRITZ!Box from the mains before cleaning.
- Wipe the FRITZ!Box with a slightly moist, lint-free cloth or an anti-static cloth.
- Do not use any strong detergents or solvents for cleaning.
- Do not use any wet cloths for cleaning.

# Index

## A

access profiles.....	92
active power.....	260
adapter	
TAE adapter.....	44
adjust time zone.....	200
advanced view.....	58
alarm.....	116, 243
alternating.....	241
Android smartphone.....	47
answering machine.....	109, 179, 233
apps	
FRITZ!App Fon.....	47
MyFRITZ!App.....	212
auto channel (wireless LAN).....	158
auto update.....	193
automatic outside dialing.....	220
AVM services.....	88

## B

baby monitor.....	230
band steering.....	159
basic configuration.....	54
blacklist.....	94
block caller.....	113
broadcast call.....	236
busy signal.....	263
buttons	
functions.....	23
overview.....	23

## C

cable	
coaxial cable.....	32
LAN cable.....	138
network cable.....	36
cable connection	
configuring.....	61
connecting.....	32
internet access.....	32, 61
cables.....	16

## call

holding.....	241
missed.....	106, 179
picking up.....	235
picking up from call waiting.....	238
transfer.....	237
call block.....	113
call diversion	
configuring.....	112, 222
for all calls.....	222
for FON port.....	226, 228
for telephone number.....	224
switching off.....	223, 225
call forwarding.....	112
call list.....	106
call waiting.....	67
CE conformity declaration.....	267
change language.....	198
change regional options.....	199
choice of location.....	260
cleaning.....	9, 268
CLIR.....	239
coaxial cable.....	32
conference call.....	240
configuration.....	50
telephones.....	67
configuration by telephone.....	217
configuring.....	59
automatic update.....	193
door intercom system.....	69
external answering machine.....	67
external fax machine.....	67
internet access.....	179, 203
push services.....	179, 203
schedule.....	157
telephone.....	202
telephone number.....	66, 203
timer.....	71
wizards.....	202
configuring MyFRITZ!.....	210

configuring schedule.....	71	copyright.....	267
configuring telephone book.....	107	cordless telephone	
configuring telephone numbers.....	66, 203	configuring.....	202
configuring timer.....	71	registering.....	42
connecting.....	27	corporate info.....	267
cable connection.....	32	customer documentation.....	12
choice of location.....	29	customer service.....	255
computer.....	36		
cordless telephone.....	42	<b>D</b>	
DECT telephone.....	42	data	
door intercom system.....	49	push services.....	179
electrical power.....	33	restoring.....	189
fax machine.....	44	saving.....	188, 209
hub/switch.....	37	data protection.....	88
IP telephone.....	45	data transfer.....	88
ISDN devices.....	45	declaration of CE conformity.....	267
mobile network.....	34	decommissioning.....	257
network device.....	36	DECT	
possibilities.....	31	encryption.....	167
smartphone.....	47	radio frequencies.....	262
telephone.....	42	switching on and off.....	168
USB devices.....	141	using repeaters.....	167
connecting a computer		DECT base station.....	19, 42, 165
via wireless LAN.....	38	DECT cordless telephone	
wake on LAN.....	140	configuring.....	202
with network cable.....	36	registering.....	42
connecting a fax machine.....	44, 202	DECT Eco.....	166
connecting a network device		device properties.....	260
IP address automatically.....	136	DHCP server.....	129
overview.....	123	diagnostics	
via network cable.....	36	function.....	171, 203
via USB.....	141	overview.....	170
via wireless LAN.....	38	security.....	173, 203
connecting network devices		diagnostics data.....	88
Smart Home device.....	152	dial tone.....	263
connection data.....	179	dialing rule.....	117
connection sockets.....	21	disposal.....	258
connector panel.....	21	Do Not Disturb.....	115
consultation.....	241	documentation.....	12
contacts.....	107	door intercom system	
conventions.....	14	configuring.....	69
conversation		connecting.....	49
missed.....	106	dynamic DNS.....	98
picking up from call waiting.....	238		

**E**

ECT .....	237
electrical power	
connecting.....	33
email notifications.....	179
emergency IP address.....	127, 252
energy	
FRITZ!Box consumption.....	70
saving .....	70
event log.....	177
expanding a wireless radio network....	64
extending wireless LAN range.....	63

**F**

factory settings.....	196
FAQs.....	254
fax function.....	111, 179
features.....	17, 18
filter lists for internet use.....	94
firmware	
factory settings.....	245
push service.....	180
updating.....	203
version.....	83
firmware update.....	191
forgot	
password.....	185
forgot password.....	180
forwarding calls.....	222
frequency ranges in wireless LAN.....	158
FRITZ!App Fon.....	47
FRITZ!Box name.....	151
FRITZ!Box password.....	183
FRITZ!Box users.....	183
FRITZ!Box web address.....	212
FRITZ!NAS	
access by computer.....	208
expanding storage.....	207
password protection.....	207
saving data.....	209
user interface.....	205

**FRITZ!OS**

factory settings.....	196, 245
FRITZ!Box name.....	151
loading settings.....	189
push service.....	180
restoring settings.....	189
saving settings.....	188
update .....	203
updating.....	191
version.....	83
wizards.....	202

FRITZ!VPN.....	102
FTP .....	99
FTPS.....	99
function diagnostics.....	171, 203
functions.....	17, 18

**G**

green mode.....	70
guest access.....	160
LAN .....	138
wireless.....	179
GUI .....	50
guidelines for public networks.....	261

**H**

handling.....	29
hazard warnings.....	8
help with problems	
documentation.....	12
Knowledge Base.....	12
online help.....	12
support.....	255
hibernation.....	157
holding.....	241
home network.....	19, 119
hotspot (WiFi)	
private .....	160
public .....	160
hotspot (wireless LAN).....	160
HSPA.....	34, 62
HTTPS.....	99
hub	
LAN .....	37
USB .....	141

humidity.....	260
<b>I</b>	
info mail.....	179
instructions for use.....	12
interfaces	
description.....	261
internal calls.....	220, 236
Internet access	
possibilities.....	31
internet connection	
configuring.....	203
connection information.....	179
mobile network.....	34
internet protocol	
version 4.....	126
version 6.....	103, 132
internet router.....	18
internet telephone number.....	66
internet use	
blocking websites.....	90, 92, 94
filter lists.....	94
prioritizing.....	95
push service.....	179
time limits.....	90, 92
IP address	
emergency IP.....	252
in Linux.....	137
in Mac OS X.....	137
in Windows.....	136
obtaining automatically.....	136
push service.....	180
IP telephone.....	45
iPhone.....	47
IPv4 .....	126
IPv6 .....	103, 132
ISDN devices.....	45
<b>K</b>	
keypad codes.....	217, 242
keypad shortcuts.....	242
Knowledge Base.....	12

**L****LAN**

connecting.....	36
guest access.....	138
LAN cable.....	138
LEDs.....	24
freely assignable "Info" LED.....	181
LEDs flashing.....	24
legal notice.....	264
loading factory settings	
via user interface.....	196
with FRITZ!Fon.....	245
locking buttons.....	182
log files.....	179
log information.....	179
logging off of the user interface.....	56
login	
FRITZ!Box password.....	183
FRITZ!Box user account.....	183
possibilities.....	185
login methods.....	183, 185
logout.....	56
<b>LTE</b>	
internet access.....	62
internet connection.....	34

**M**

MAC address.....	15
maintenance.....	88
malfunctions	
support.....	255
troubleshooting chart.....	249
manual.....	12
manufacturer's warranty.....	264
media server.....	149



- menus in the user interface
  - DECT ..... 164
  - diagnostics.....169
  - home network.....118
  - internet.....86
  - overview.....82
  - system ..... 176
  - telephony.....105
  - wireless.....155
  - wizards.....201
- Mesh..... 72, 73, 76, 78
  - adopting telephone numbers..... 81
  - telephony..... 81
- Mesh Master..... 73
- Mesh Repeater..... 73
- mobile network..... 34
- MyFRITZ!
  - account.....211
  - configuring MyFRITZ!App with .. 216
  - iOS
    - creating a MyFRITZ! account.....214
    - FRITZ!Box web address..... 212
    - in home network.....213
    - in the internet.....211
    - MyFRITZ!App..... 212
    - myfritz.box.....213
    - myfritz.net..... 211
    - on a mobile device.....212
    - Setting up MyFRITZ!App with .. 215
    - Android
      - using MyFRITZ! account..... 214
- N**
- NAS .....204
- network access interfaces..... 261
- network cable.....36, 138
- network connections..... 123
- network key.....15, 40
- network settings
  - DHCP server..... 129
  - IPv4 ..... 126
  - IPv4 addresses..... 129
  - IPv6 .....103, 132
  - static IP route.....134
- night service.....157
- notifications.....179
- O**
- online help..... 12
- operating system.....191
- operating system: FRITZ!OS
  - restoring factory settings.....196
  - updating..... 191
- operating temperature.....260
- operation by telephone.....217
- operation requirements..... 26
- P**
- package contents..... 16
- parental controls..... 90
- password
  - characters allowed..... 186
  - forgot .....185
- password for FRITZ!Box.....183
- password protection
  - forgot password..... 180
  - push service..... 180
- password rules..... 185, 186
- password, wireless LAN..... 15
- phone number
  - blocking.....113
  - dialing rule.....117
- picking up.....235
- picking up from call waiting.....238
- pickup.....235
- placement..... 29
- port sharing..... 96
- ports
  - interfaces.....261
- power
  - FRITZ!Box consumption.....260
  - saving ..... 148
- power consumption..... 260
- prioritizing internet use..... 95
- public network standards.....261
- push services.....179, 203
- Q**
- quick guide..... 12

## R

radio frequencies	
DECT .....	262
radio interference.....	10
wireless LAN.....	158
reassigning "Info" LED.....	181
recycling.....	258
registering handset.....	42
remote access	
FRITZ!VPN.....	102
MyFRITZ!.....	210
VPN .....	99
repeater (wireless LAN).....	63
requirements for operation.....	26
resetting	
new start.....	190
resetting firmware.....	196
resolving problems.....	247
restarting.....	190
restoring.....	196, 196
factory settings.....	245
FRITZ!Box settings.....	189, 203
restoring factory settings	
via user interface.....	196
with FRITZ!Fon.....	245
room monitoring.....	230
rules for passports.....	186
rules for passwords.....	185

## S

safety	
handling.....	29
safety instructions.....	8
safety instructions.....	8
saving	
FRITZ!NAS data.....	209
saving power	
overview.....	70
potential savings.....	70
saving power.....	70
Smart Home.....	71
USB settings.....	148

## security

check .....	203
checking.....	173
FRITZ!IOS update.....	191
info mail.....	180
login .....	183
password protection.....	183
push services.....	179
saving settings.....	188, 203
user account.....	183
VPN .....	99
wireless LAN encryption.....	39
security diagnostics.....	173, 203
serial number.....	15
service.....	255
session ID.....	56, 56
setting up.....	59
settings.....	50
FRITZ!Box password.....	183
FRITZ!Box users.....	183
IP address.....	127
loading.....	189
network.....	126, 132
push service.....	180
restoring.....	189, 203
saving .....	188, 203
user interface.....	50
setup	
basic configuration.....	54
Smart Home.....	20
Smart Home devices.....	71, 152, 179
smartphone.....	47
software	
push service.....	180
updating.....	203
version .....	83
software: FRITZ!IOS	
restoring factory settings.....	196
updating.....	191
speed in the home network.....	95
standard view.....	58
starting operation.....	27
static IP route.....	134
storage (NAS).....	204

- storage temperature..... 260
- streaming..... 149
- structure..... 17
- support
  - by email..... 255
  - instructions for use..... 12
  - Knowledge Base..... 12
  - online help..... 12
- symbols..... 14
- T**
- technical specifications..... 260
  - active power..... 260
  - ambient conditions..... 260
  - device properties..... 260
  - humidity..... 260
  - interfaces..... 261
  - ports ..... 261
  - power consumption..... 260
  - temperature..... 260
  - tones ..... 263
  - wireless LAN radio frequencies..... 262
- telephone
  - alarm function..... 116, 243
  - configuring..... 202
  - connecting..... 18, 42
  - Do Not Disturb..... 115
  - keypad codes..... 217, 242
  - room monitoring..... 230
- telephone call
  - broadcast call..... 236
  - call list ..... 106
  - conference call..... 240
  - diverting..... 112, 222
  - holding ..... 241
  - missed ..... 106, 179
  - picking up from call waiting..... 238
  - transfer..... 237
- telephone number
  - assigning..... 67
  - blocking..... 113
  - configuring..... 66, 203
  - dialing rule..... 117
  - suppressing..... 239, 239
- telephone system..... 18
- telephones
  - configuring..... 67
- telephony
  - Mesh ..... 81
- templates..... 153
- terminal devices
  - configuring..... 67
  - connecting..... 18
- test
  - function diagnostics..... 171, 203
  - security diagnostics..... 173, 203
- three-party conference call..... 240
- timeout..... 56
- tones..... 263
- transferring..... 237
- troubleshooting..... 247
  - documentation..... 12
- type label..... 15
- U**
- UMTS..... 34, 62
- update..... 191
  - automatic..... 193
  - manual..... 192
  - overview..... 191
  - push service..... 180
  - wizard ..... 191, 203
- usage data..... 179
- USB device
  - access rights..... 143
  - configuring..... 141
  - connecting..... 142
  - settings..... 148
  - suitable for FRITZ!Box..... 141
- USB ports..... 19
- user account..... 183

- user interface.....50
  - change language..... 198
  - factory settings..... 196
  - fallback..... 196, 245
  - firmware update..... 191
  - FRITZ!Box users..... 183
  - FRITZ!NAS..... 205
  - login ..... 183
  - logout ..... 56
  - opening..... 51
  - password protection..... 183
  - remote access..... 99
  - updating FRITZ!OS..... 191
- user names
  - characters allowed..... 186
  - rules for naming..... 185
- V**
- views of the user interface
  - advanced view..... 58
  - standard view..... 58
  - switching views..... 58
- voice menu of answering machine..... 234
- voice to mail..... 109
- VPN
  - remote access..... 101
  - service portal..... 102
- W**
- wake on LAN..... 140
- warranty..... 264
- whitelist..... 94
- Wi-Fi Protected Setup..... 41
- WiFi
  - Mesh ..... 72
- wireless access point..... 18
- wireless guest access..... 160, 179
  - switching on/off..... 162
- wireless LAN
  - auto channel..... 158
  - band steering..... 159
  - computer..... 38
  - configuring radio network..... 156
  - encryption..... 39
  - expanding radio network..... 64
  - extending range..... 63
  - installing Mesh..... 75
  - location for the FRITZ!Box..... 29
  - Mesh ..... 76, 78
  - network key..... 15, 38, 40
  - password..... 15, 40
  - radio channel..... 158
  - radio frequencies..... 158, 262
  - reception..... 29
  - schedule..... 157
  - standards..... 261
  - switching on/off by button..... 157
  - switching on/off by telephone..... 231
  - WPS ..... 41
- wireless LAN frequency ranges..... 262
- wireless LAN radio frequencies..... 262
- wireless repeater..... 63
- wizards..... 202
- WPS ..... 41